



STAFF REPORT

City Council

Meeting Date:

9/13/2022

Staff Report Number:

22-172-CC

Study Session:

Menlo Park Community Campus project updates including recreation and community programs survey results

Recommendation

Staff recommends that the City Council review this report containing updates about the Menlo Park Community Campus (MPCC) project, including the results of a survey of Menlo Park residents' needs and desires for recreation and community programs. Staff seeks feedback and direction from City Council about the findings of the resident survey to help inform and shape the planning for operations and programming in the MPCC.

Policy Issues

City Council sets policy and goals and provides direction to staff regarding municipal projects and services to the Menlo Park community. City Council established the MPCC project as one of the City's top priorities.

Background

On December 16, 2019, Facebook (now Meta) submitted its proposal for exploring the funding and development of a new multigenerational center to incorporate the former Onetta Harris Community Center, Menlo Park Senior Center, Belle Haven Youth Center (child care), Belle Haven Pool and branch library.

On January 12, 2021, City Council approved the architectural control, use permit, funding and improvements agreement for the MPCC project located at 100-110 Terminal Avenue. City Council requested further review of several design elements of the proposed pool area. Those items were discussed January 26, 2021, and February 1, 2021. City Council approved the pool design elements February 1, 2021.

Construction of the MPCC project began in November 2021. The project's concrete foundation was completed in March 2022 and the steel framing was completed in April 2022.

City Council created the MPCC subcommittee to work with City staff and the community on the MPCC project. The MPCC Subcommittee is currently comprised of Mayor Nash and City Councilmember Taylor. The MPCC subcommittee convened a working group of Menlo Park residents to support and advise the subcommittee's work.

On May 24, 2022, City Council reviewed an informational report containing MPCC project updates and a draft survey of Menlo Park residents' needs and interests related to recreation and community programming in the MPCC.

On August 23, 2022, City Council reviewed aquatics-related excerpts from the above-noted survey.

Analysis

The MPCC project is entering an exciting new phase. The long-held dream of a new community campus in Belle Haven is visibly taking shape as the construction progresses and an inspiring new landmark rises at 100 Terminal Avenue. Planning for the programming and operations of the new campus is proceeding apace with robust community involvement and input. With the project moving into a particularly active phase of development, staff anticipates providing updates to the MPCC Subcommittee and City Council on a regular basis going forward.

Resident survey – recreation and community programs

City Council February 8, 2022, directed staff to conduct an analysis of the city’s aquatics program needs at Burgess Pool and the future MPCC aquatics center, including a survey of Menlo Park residents. The MPCC Subcommittee, currently comprised of Mayor Nash and City Councilmember Taylor, subsequently expressed interest in leveraging the opportunity of a resident survey to also gain insight into residents’ needs and interests related to recreation and community programming in the MPCC.

Staff prepared a resident survey to gain insight in all these areas, with input from the MPCC Subcommittee and its working group of Belle Haven residents, the Library Commission, and the Parks and Recreation Commission. Staff transmitted the survey questions to City Council for review May 24. The survey opened June 13 and was distributed to Menlo Park residents in electronic and paper formats, in English and Spanish. The survey had over 900 respondents by the time the survey closed August 10.

The complete survey results are attached to this report. (Attachment A.)

Several of the questions asked survey respondents to rate items as either "not at all important," "somewhat important," or "very important." Responses of "not at all important" were assigned a numeric value of 1; "somewhat important" were assigned a value of 2; and "very important" were assigned a value of 3. The charts in Attachment A show these weighted average ratings for each item. Higher ratings indicate that survey respondents overall assigned higher relative importance to those items. Items that were rated with high average relative importance (2.35 or higher) are summarized in the following Table 1:

Table 1: High average relative importance (2.35 or higher)	
Survey rating	Item
2.78	Wireless internet access (Wi-Fi) in the library
2.74	Quiet places to read and study
2.67	Books in paper format
2.67	Storytimes for young children
2.67	[Athletic] Programs are focused on the needs of Menlo Park residents
2.65	Swimming pools are open year-round
2.64	Swimming pools are open seven days per week
2.63	Swimming pools are focused on the needs of Menlo Park residents
2.62	Neighborhood / family access to athletic fields for casual use and play



2.59	[Community] Programs/ classes are focused on the needs of Menlo Park residents
2.59	Books that are the newest and most popular bestsellers
2.59	Swimming lessons for children
2.56	Children access to athletic fields for casual / drop-in play
2.55	Teens have space to socialize, read and study after school and weekends
2.55	Books that offer a wide range of different viewpoints including views I don't agree with
2.55	Books that reflect the cultures, needs and interests of local / neighborhood residents
2.54	Open swim / community swim time in big pool
2.52	Swimming pools have free or discounted fees for Menlo Park residents
2.52	Books in electronic / digital formats (e-books, e-audiobooks)
2.51	Homework help for children and teens after school
2.5	[Athletic] Programs are free or have discounted fees for Menlo Park residents
2.45	Adult lap swimming
2.45	[Community] Programs/ classes are free or have discounted fees for Menlo Park residents
2.43	English as Second Language (ESL) resources
2.42	Adult literacy tutoring to help adults learn how to read / improve reading skills
2.42	Job skills / job readiness / job seeker resources and training
2.39	Books that are classics that I read in school / as a child
2.36	Food distribution, food insecurity advice and support
2.35	Health care navigation and support
2.35	Music / performing arts
2.35	Health and wellness / yoga / meditation

Lower ratings indicate that survey respondents assigned lower relative importance to those items. Items that were rated with low average relative importance (1.90 or lower) are summarized in the following Table 2:

Table 2: Low average relative importance (1.90 or lower)	
Survey rating	Item
1.75	Football/ rugby – organized youth/adult league
1.83	Money management, personal budgeting
1.84	Swimming pools attract participants from outside Menlo Park who are charged higher fees
1.85	Competitive swimming / sports have priority to use the pools for training and competitions
1.86	Lacrosse – organized youth league
1.87	Martial arts
1.88	[Athletic] Programs attract participants from outside Menlo Park who are charged higher fees
1.88	[Community] Programs/ classes attract participants from outside Menlo Park who are charged higher fees

Informed by the resident survey results and consistent with previous direction received from City Council related to MPCC programming, staff will continue to work with stakeholders including the MPCC Subcommittee and working group, Library Commission, and Parks and Recreation Commission to incorporate the following considerations into the MPCC program planning. Staff seeks City Council’s feedback and direction on these considerations as well as any other elements that City Council desires to incorporate into the program planning process. The following considerations are numbered for convenience only, and are in no particular order or priority:

1. Prioritize the program elements that survey respondents rated with the highest relative importance.
2. Include programs and classes that are not currently offered on a regular basis, but were rated with high importance by survey respondents. For example:
 - A. Homework help for children and teens after school
 - B. Job skills / job readiness / job seeker resources and training
 - C. Food insecurity advice and support
 - D. Health care navigation and support
3. Prioritize programs and classes that are free or have discounted fees for Menlo Park residents.
4. Deprioritize programs that primarily attract participants from outside Menlo Park, and/or that survey respondents rated with low relative importance
5. Prioritize casual and drop-in play opportunities for children and families, especially Menlo Park residents
6. Aquatics program considerations will be addressed in the context of the upcoming aquatics operator request for proposals (RFP) process.

Staff will incorporate City Council’s feedback and direction into the planning process and will present preliminary MPCC staffing and program options to City Council tentatively in January/February 2023.

MPCC environmental sustainability features

The MPCC project is being designed to LEED Platinum standards for environmental sustainability – the highest available designation. The Library Commission and Parks and Recreation Commission on June 22 convened a joint study session to receive updates about the MPCC project and invite public input. Among the items reviewed at the June 22 joint study session was a presentation by project architects Hart Howerton about the MPCC project’s many environmental sustainability features (Attachment B.)

MPCC furnishing layouts

The MPCC subcommittee and working group requested additional visual aids that show the proposed furnishings in layout. City staff worked with the architects to develop several “dollhouse” visualizations that show the proposed furnishings to scale in a “3-D” format that is visually engaging and, hopefully, clearer and more evocative than the standard two-dimensional diagrammatic view (Attachment C.)

Construction tours

Residents and other interested parties are invited to participate in neighborhood-oriented tours of the MPCC construction site. The intent of the tours is to provide Menlo Park residents, especially from the Belle Haven neighborhood, the opportunity to observe and experience the project while it is under construction. Tours have been scheduled at various stages of the project construction. The first tour took place on August 19 and was well-attended by neighborhood residents. All tours take place on afternoons after construction work has ended for the day.

- Friday, October 21 – This tour will feature the interior stairs and passageways and a walkthrough of the structure
- Friday, January 6 – Tour of the swimming pools and splash pad under construction, in addition to a walkthrough of the main structure
- Friday, March 10 – Focus on the gymnasium and other major interior rooms, in addition to a walkthrough of the structure

Tour participants must be 18 years of age or older. Advance registration and liability waiver are required. The MPCC project is an active construction site with uneven surfaces and other potential hazards. Sturdy footwear is required. Personal protective equipment (hard hats, hi-visibility vests) will be provided.

MPCC project timeline

The MPCC project construction began in November 2021 and the construction work is proceeding at a brisk pace. Currently, unprecedented supply chain issues are prevalent throughout the construction industry, and continue to impact the timely availability of critically important infrastructure, equipment and materials. There are potential supply chain delays with critical electrical infrastructure equipment, and the team is exploring all available options to avoid these potential delays. In the event that this electrical infrastructure equipment needed for the MPCC project are delayed due to supply chain issues, the project’s completion timeline will shift by several months to late 2023 or early 2024.

Beechwood School temporary entrance change and Kelly Park access

As part of the ongoing construction for the MPCC project, the Beechwood School parking lot will be under construction from late August to December 2022. The construction activity involves trenching and underground utility work. Access to Kelly Park will still be available by pedestrian walk path. Cars entering and exiting Kelly Park will have limited parking spaces at the field and are asked to carpool, use public transit or bike to help ease traffic congestion. During construction, access to Beechwood School will be shifted to an alternate entrance at 243 Terminal Avenue. To help reduce traffic impacts during school drop-off/pick up times, the City created a temporary school loading zone on the north side of Terminal Avenue, between Plumas Avenue and Modoc Avenue.

Parking management plan

Staff has begun to develop a parking management plan and options for City Council to consider related to the MPCC parking areas. Parking considerations could include time limited parking to ensure parking is used by visitors, designating certain parking spaces during certain times of day, and potentially restricting overnight parking. Other considerations could tentatively include: quantity and location of bicycle parking, pedestrian routes, and other factors that pertain to the management of the parking area. Key elements of the planning process include: review relevant past parking studies and data; conduct public outreach to

gather community input; develop a draft plan for review by the Complete Streets Commission; then present a final draft plan to City Council review and approval targeted in January/February 2023.

Pool heat pumps and exception to noise ordinance

To meet City Council's goals of sustainable design and construction for the MPCC project, no fossil fuels will be consumed in the operation of the building. To heat the two new pools, the project plans call for five air source heat pumps (ASHPs), which will be in operation when heating the pool, year round. Several studies were undertaken to carefully select the most efficient and capable equipment, while minimizing the amount of noise created. Electrical heating equipment generates more noise than natural gas boilers. As a result, there will be times when the electric-powered ASHPs are running and exceed the Menlo Park noise ordinance. The project team evaluated several noise mitigation strategies, including:

- Aftermarket attenuators (dampeners) attached to the ASHPs to lower the output would not work sufficiently to lower the sound levels
- Sound walls installed surrounding the ASHPs. The proximity of the ASHPs to the property line on the south (and clearance required by the ASHPs for air circulation), the gymnasium to the north, and required fire access clearance required on the East and West do not make it possible to install effective sound barriers anywhere on site.
- Other solutions such as relocating pumps to the pool house area increased the sound limits at the residential property lines, making alternatives infeasible.

Based on the above findings, the project team determined that it is infeasible to mitigate the noise to levels that comply with the noise ordinance. Staff is preparing to seek an exception to the noise ordinance at the Planning Commission tentatively in October 2022.

Upcoming City Council items

Items relevant to the MPCC project are tentatively scheduled for City Council review and/or approval in the coming months.

- September/October – Authorize staff to issue a RFP for an aquatics operator at Burgess Pool and the new MPCC Pool
- November/December – Provide direction for updating City Council Policy CC-86-0001, "Naming and/or changing the name of facilities" (1986)
- December/January – Award of contract and budget authorization for procurement of furnishings and non-fixed equipment for the MPCC
- January/February – Preliminary options for parking management plan
- January/February – Preliminary considerations for MPCC staffing and operations

Impact on City Resources

Staff estimates the value of Meta's contribution toward the MPCC project completion at approximately \$40 million. The City's share of the project construction includes commitments at both a base level and project enhancements totaling approximately \$15.75 million from various funding sources authorized by the City Council project approvals January 12, 2021 and February 1, 2021. The ongoing cost impacts of operating the new center will be established over the next several months as part of the MPCC operational planning process. As part of the new center opening, it is anticipated that existing services that are currently housed in interim locations will be relocated to the new center; some services that were suspended or reduced during the MPCC construction and/or due to pandemic impacts would likely be restored to pre-construction/pre-pandemic levels; and some service level enhancements could be necessary or desired in order to operate the center in the manner and capacity envisioned by the City Council and the community.

The intent is to engage the community over the next several months through the MPCC operational planning process to identify what is desired regarding the center's programs and operations, which can then inform projected operating costs for the City Council to make budgeting decisions during fiscal year 2022-23.

Environmental Review

On January 12, 2021, the City Council found the MPCC project categorically exempt pursuant to the California Environmental Quality Act (CEQA) Guidelines Section 15302 Replacement of Existing Facilities. The project has substantially the same purpose and capacity as the existing facilities, and this exemption allows for reasonable increases in square footage to accommodate replacement facilities. On January 21, 2021, staff filed a notice of exemption with the San Mateo County Clerk.

Public Notice

Public notification was achieved by posting the agenda, with the agenda items being listed, at least 72 hours prior to the meeting. In addition, the City sent electronic notices via Nextdoor, Facebook and directly to project email and text update subscribers from the project page (Attachment D.)

Attachments

- A. Resident survey – recreation and community programs
- B. Sustainability presentation
- C. Furniture layouts
- D. Hyperlink – project page: <https://menlopark.org/communitycampus>

Report prepared by:
Sean Reinhart, Library and Community Services Director

1. What neighborhood of Menlo Park do you live in now?

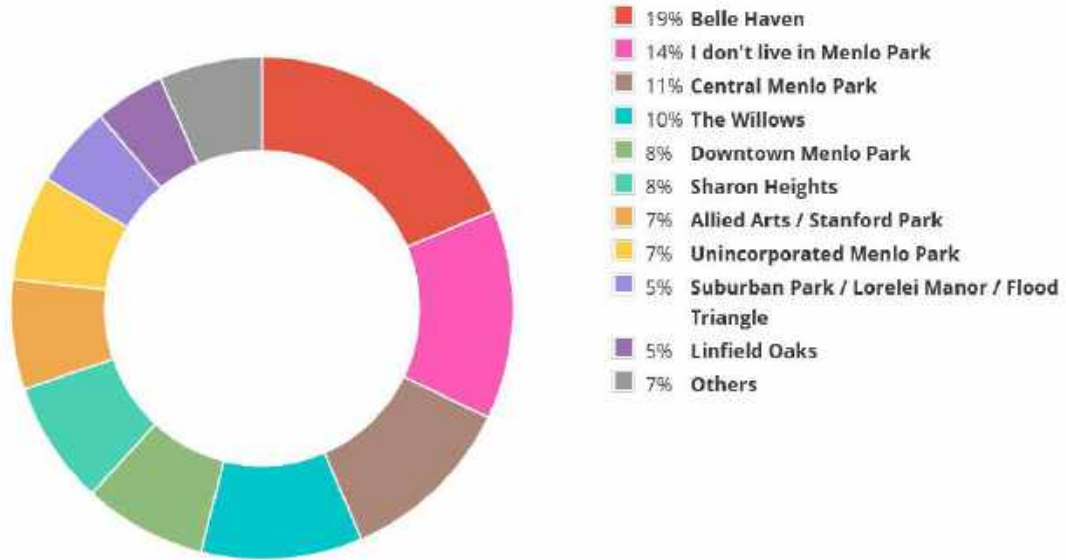

932 respondents

2. How long have you lived in Menlo Park?

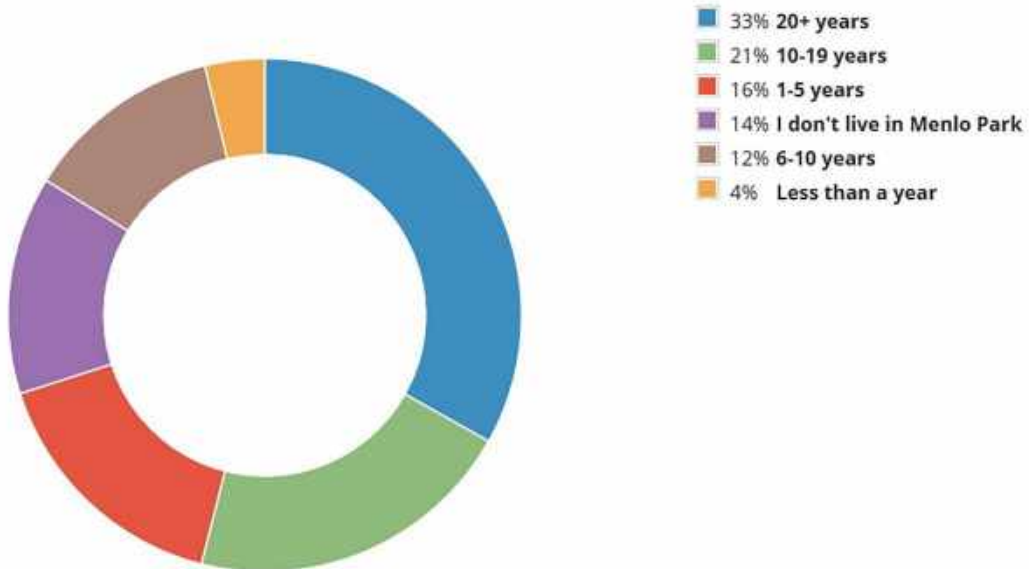

932 respondents

18. What is your age?

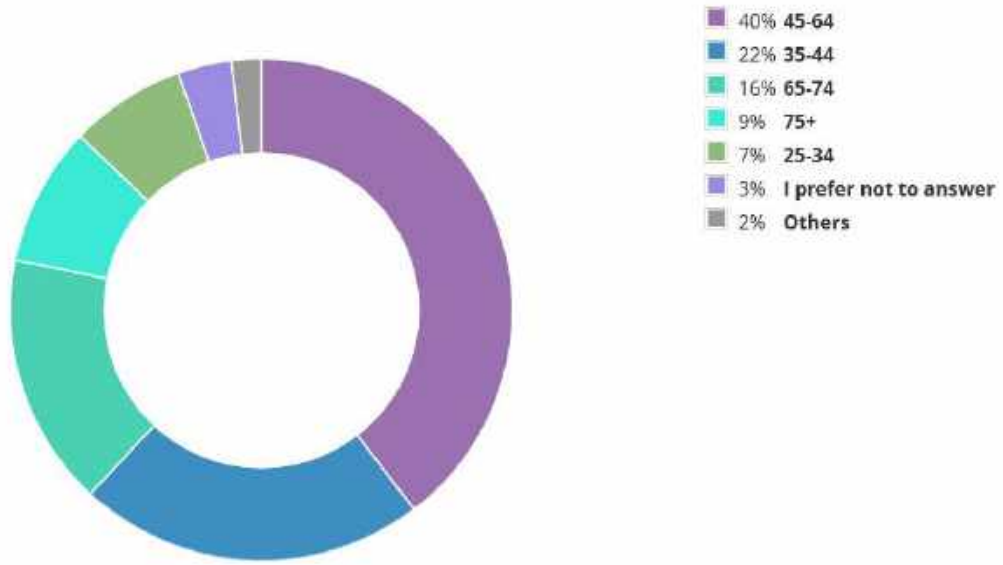

724 respondents

3. What age groups live in your household? (Check all that apply)

77%	Adults	669 ✓
27%	Children	239 ✓
27%	Adults 65+	234 ✓
23%	Teenagers / tweens	204 ✓
13%	Infants/ toddlers	114 ✓
1%	I don't know / I prefer not to answer	8 ✓

870 Respondents

4. How often do you typically use or visit these locations operated by the City of Menlo Park?

	Never	Rarely, once a year or less	A few times a year	Once or twice a month	Once or twice a week	More than once a week
Afterschool programs	74% Never	5% Rarely, once a year or less	5% A few times a year	4% Once or twice a month	5% Once or twice a week	7% More than once a week
Athletic fields (soccer, baseball, etc.)	34% Never	15% Rarely, once a year or less	17% A few times a year	11% Once or twice a month	12% Once or twice a week	10% More than once a week
Community and cultural events	18% Never	22% Rarely, once a year or less	45% A few times a year	11% Once or twice a month	3% Once or twice a week	3% More than once a week
Dog park	67% Never	7% Rarely, once a year or less	10% A few times a year	6% Once or twice a month	5% Once or twice a week	6% More than once a week
Gymnasium (basketball, volleyball, etc.)	56% Never	17% Rarely, once a year or less	14% A few times a year	5% Once or twice a month	5% Once or twice a week	3% More than once a week
Meeting rooms / facility rentals	67% Never	21% Rarely, once a year or less	8% A few times a year	3% Once or twice a month	1% Once or twice a week	1% More than once a week
Parks / green spaces	6% Never	5% Rarely, once a year or less	15% A few times a year	22% Once or twice a month	20% Once or twice a week	32% More than once a week
Picnic areas	23% Never	22% Rarely, once a year or less	27% A few times a year	16% Once or twice a month	7% Once or twice a week	6% More than once a week

4. How often do you typically use or visit these locations operated by the City of Menlo Park?

	Never	Rarely, once a year or less	A few times a year	Once or twice a month	Once or twice a week	More than once a week
Public libraries	12% Never	12% Rarely, once a year or less	22% A few times a year	28% Once or twice a month	16% Once or twice a week	10% More than once a week
Recreation center	37% Never	25% Rarely, once a year or less	19% A few times a year	10% Once or twice a month	4% Once or twice a week	5% More than once a week
Senior programs	80% Never	6% Rarely, once a year or less	5% A few times a year	2% Once or twice a month	2% Once or twice a week	4% More than once a week
Skate park	81% Never	7% Rarely, once a year or less	7% A few times a year	3% Once or twice a month	1% Once or twice a week	2% More than once a week
Swimming pools	40% Never	11% Rarely, once a year or less	15% A few times a year	9% Once or twice a month	8% Once or twice a week	18% More than once a week
Tennis / pickleball courts	44% Never	7% Rarely, once a year or less	10% A few times a year	8% Once or twice a month	11% Once or twice a week	20% More than once a week
Walking / hiking trails	14% Never	8% Rarely, once a year or less	21% A few times a year	21% Once or twice a month	16% Once or twice a week	19% More than once a week

844 respondents

Q5. How important are the following community programs and classes?

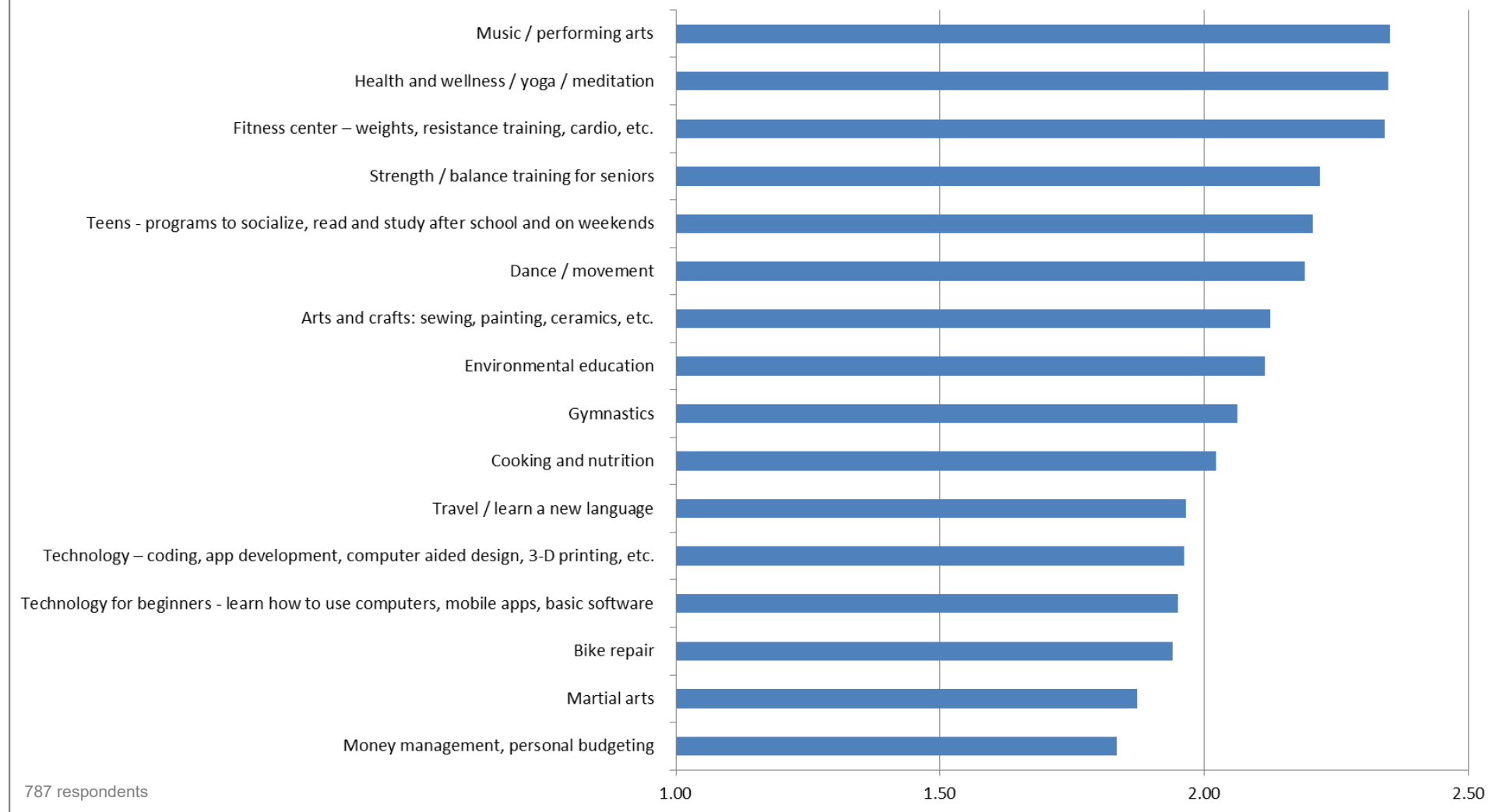

This chart shows average relative importance as rated by survey respondents. Respondents had the option to rate each item as either "not at all important," "somewhat important," or "very important." Items rated "not important" are assigned a value of 1; "somewhat important" a value of 2; and "very important" a value of 3. The chart shows the average value of all ratings for each item. Higher average ratings indicate higher relative importance to the survey respondents.

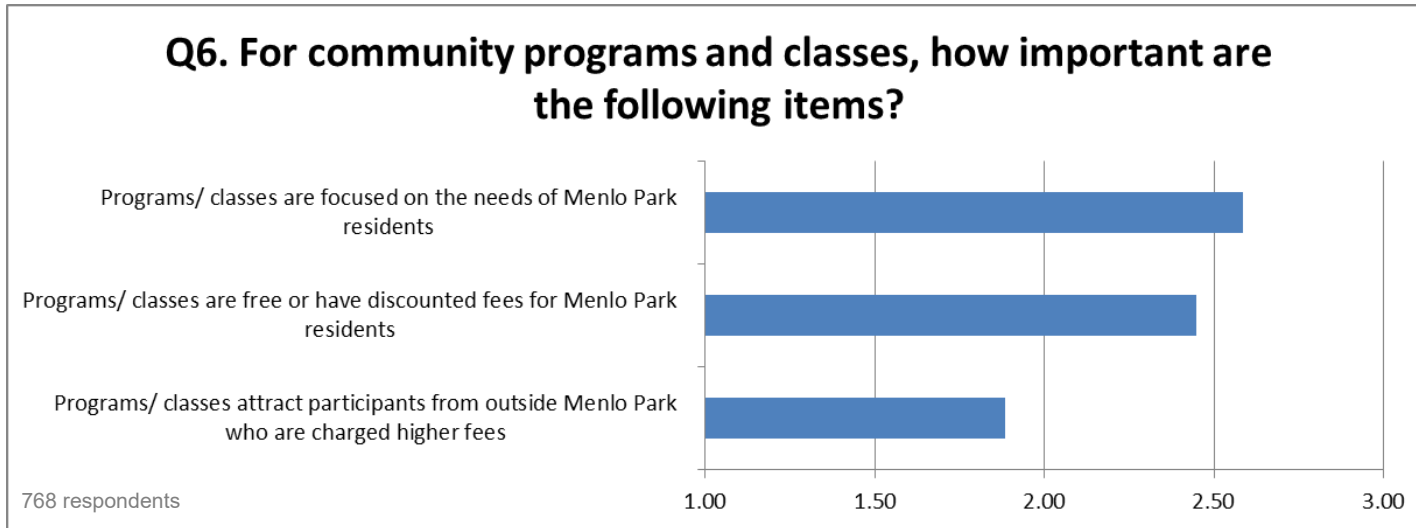

This chart shows average relative importance as rated by survey respondents. Respondents had the option to rate each item as either "not at all important," "somewhat important," or "very important." Items rated "not important" are assigned a value of 1; "somewhat important" a value of 2; and "very important" a value of 3. The chart shows the average value of all ratings for each item. Higher average ratings indicate higher relative importance to the survey respondents.

Q7. Please tell us your ideas, needs, and suggestions for the city community programs and classes.	
1	Would love to have more pickleball courts available in Menlo Park. Ideally at Nealon Park, where there is a critical mass of players already using the courts.
2	It is 3 to us to have more pickleball courts in Nealon Park, they are almost always full while the tennis courts are underutilized and could be made into temporary pickleball courts while retaining one for tennis. Pickleball creates a great sense of community but also is good for our mental well being. Check out Mitchell Park in Palo Alto. Thank you.
3	My wife and I play pickleball practically everyday since August 2021 at Nealon Park. We need more pickleball courts at Nealon. Shared pickleball courts on tennis courts 3 and 4. When the tennis players leave the pickleball nets can be placed on the tennis courts. It is possible to make 4, 6 or 8 pickileball courts on tennis courts 3 and 4. Thank you for supporting pickleball in Menlo Park.
4	We need more access to a pool for regular swimming lessons and open swim. Burgess is not handling their scheduling system well. I'm hoping Onetta Harris will be better when it reopens. Getting gymnastics back would be great too.
5	WE need more pickleball courts.
6	We desperately need more pickleball courts at Nealon Park
7	We need more pickleball courts. We need to priority today ver tennis at all times, better if permanent. Pickleball UNLIKE tennis is an open community and shouldn't be places piecemeal around the city. We need a central location or two as there many discourage players who either find the courts empty due to a lack of community or over crowded courts and being turned away.
8	Pickelball has been in creasing in popularity, but Menlo Park has not kept up with enough courts to meet this demand. Tennis courts usage has been on the decline, so some tennis courts should be changed to dual usage for both tennis and pickelball. There is a tremendous amount of illegal private tennis lesson at Nealon Park. I like to see enforcement policy to ban private tennis lessons.
9	Menlo Park should offer pickleball classes for all age groups. To accomodate the explosive growth of interest in pickleball we need to increase the capacity of pickleball courts in our city, both in the very near term (e.g. converting more tennis courts for both pickleball and tennis usage) and long-term (e.g. more permanent dedicated pickleball courts). Pickleball is a very social sports that promotes the sense of community and a wonderful way for our residents physical and mental well being. ; Menlo Park should offer pickleball classes for all age groups. To accomodate the explosive growth of interest in pickleball we need to increase the capacity of pickleball courts in our city, both in the very near term (e.g. converting more tennis courts for both pickleball and tennis usage) and long-term (e.g. more permanent dedicated pickleball courts). Pickleball is a very social sports that promotes the sense of community and a wonderful way for our residents physical and mental well being. For the immediate term I believe converting 2 tennis courts in Nealon Park for dual use of pickleball and tennis is a low-cost and effective way to address the pickleball community's need immediately.
10	Classes for kids and activities as well as sports for kids 7-10
11	Please bring gymnastics back. We have missed the classes and being able to do birthday parties there.
12	Classes for children, art, swimming, math, science etc
13	More pickleball courts!
14	Pickleball classes
15	Menlo Park gretly needs more pickleball facilities. Once more courts are available, there will be the potential for pickleball clinics which may be free or fee based.
16	All the ones listed above are great.
17	We need many more pickleball courts. The pickleball community continues to grow and attract people of all ages. Menlo Park needs to support this growing and active community now, by creating more shared tennis-pickleball courts, and in the future, by developing plans to expand more permanent pickleball courts in addition to the town's tennis courts.
18	More pickleball courts spread throughout the city.
19	Recreation classes need to include more variety. There are many dance, martial arts, and gymnastics classes, but the variety is lacking. For example, the only "art" classes now are sewing. The city has also repeatedly failed to program any classes for individuals with special needs or disabilities or insist that contracted instructors accommodate residents with disabilities. Instead of very specific classes, like drawing or sewing, what about a class that could accommodate a variety of abilities like Mixed Media, collage, non-representational art? Dance classes are very specific to type and age, what about a dance for all class that had a wider age and ability range so more could benefit? The community has identified the need for teen programming for many years but has yet to program for it. If teens don't have positive outlets, they will find not so positive ones.
20	Expanded pickleball courts such as at Nealon Park, not necessarily dedicated to pickleball but another tennis court with the dual stripng
21	Menlo Park residence really should have priority over venues and timeslots. Also, it needs to be VERY affordable. Not just "affordable" considering we're in the area of Atherton and many parts of Menlo Park. If you want Menlo Park residents, in particular Belle Haven residents, two be excited about using facilities and the services, you need to incentivize them. ; Being a Belle Haven resident, I realize I just can't afford things the way other people in the area can. Going to yoga classes was very affordable at the Onetta Harris community center. Also my sons went to karate there as well. Unfortunately the teacher passed away. And they could not find anybody else. I'm not sure if teachers get paid the same no matter which location they work at. I wanted my kids to do gymnastics but really can't afford the gymnastics at Arrillaga.
22	Would love access to swimming lessons and activities for young kids with affordable fees.
23	Gardening to feed the family ;) , raising bees and chickens
24	Adult King Fu, Kempo or defensive martial arts, gardening, home maintenance/ remodel classes, learn another language, solicit opportunities for local residents to offer classes based around their skills / hobbies

All comments are shown as they were written and submitted by the respondents, and are numbered in the order they were received.

Q7. Please tell us your ideas, needs, and suggestions for the city community programs and classes.	
25	Having access to child care if a caregivers would like to enroll to community center classes but unable to due to childcare issues Priority to those who reside in Belle Haven Affordable community center classes
26	Pool; gymnastics; sensory play; dance classes; Zumba for adults;
27	- Annual family membership to Burgess and other MP pools is needed - Do not use tennis courts as pickleball courts
28	Nursing rooms for nursing/lactating mothers. Infant care classes. Updated track and field.
29	Life skills for teens (handling finances, job interviews, education opportunities). Cooking.
30	More off leash dog access particularly on weekends.
31	Pool use more hours during the year.
32	2 additional mixed-use pickleball / tennis courts at Nealon, more dedicated pickleball courts in the future (across MP)
33	Open the gymnastics classes for children.
34	Just want to have weight/physical exercising classes with discounts to residents
35	Pickleball is hugely popular and growing sport. We need more courts now. Conversion of two more tennis courts at Nealon to 8 pickleball courts (which can be used for tennis or pickleball) is necessary and makes great sense for our community.
36	The pool is critically important for older adults who cannot manage the dry land exercises. However, the pool has been taken over by athletes to the exclusion of ordinary families and seniors.
37	I very much enjoyed and benefitted from Aquatic Wellness for senior citizens. Feel it is 3 to offer this service to seniors as water exercises is the most beneficial and least apt to cause injury than any other programs for Seniors.
38	water wellness programs for elderly and disabled people are important
39	I used to participate (as a Palo Alto resident) in the excellent aqua wellness program at Burgess Pool, but it has not been offered in the same format, at the same times, nor as often, since the Covid shutdown. I swim occasionally and appreciate the warm pool, but have had to find a private aqua wellness program, which is much more expensive and further away.
40	I really appreciate the option to attend meetings in the library or Rec Ctr rooms where community organizations are presenting -- such as SFBBO (about local birdwatching) or topics that offer ways to more enjoy where I/we live. I am extremely disappointed at the Burgess Pool's dropping their very successful aquawellness programming in favor of more cardio-focused aqua-exercise or PT, 1:1 type of aqua exercise that are much more expensive and not as valuable to overall whole body conditioning/wellness.
41	Please, open back gymnastics. This is only one gymnastics in Menlo Park/Palo Alto/Stanford area. The classes were so convenient (there were classes for different age kids at the same time). Coaches were super friendly and absolutely kind to kids. Kids loved environment and a huge and bright room. Please, bring it back, now the closest gymnastics for kids is in 25 min drive one way and it is packed. Thank you!
42	Please let us swim in the burgess pool. I cannot afford the private pools and burgess is always too busy with the team sheepher group
43	Please reopen arillaga gymnasium and restart gymnastics!
44	Please reopen gymnastics- such a wonderful program and we can't find anything else like it
45	Menlo Park's library is a disappointment compared to other cities (eg palo alto). It would be great to see an investment into a better one Local music and art classes for toddlers are great, but often full. I'd love to see more. I'd also love to see swim classes for infants/toddlers in menlo park
46	Lastly, it would be interesting to have local block parties to meet neighbors.
47	We would really love for the gymnastics program to be restarted.
48	Aerobic exercise classes after 4 or 5 pm Monday through Friday - Open swim time for families on weekends - Group swim lessons vs. private lessons - Open access to lap swimming in the Performance pool (early morning and evening) so that people who work during the day and can't afford Masters can continue to swim - Limiting rental to other organizations at least until 2023 when the new MPCC opens - Reasonable pricing so all Menlo Park residents can swim - Menlo Park should take back ownership of the pool and end the arrangement it has with its for-profit contractor that has been crowding out public access in favor of private programming.
49	We used classes and programs heavily when the kids were younger. Now that they're tweens/teens there doesn't seem to be as much for them. Would be nice to have a free hangout space to rival downtown and Menlo Church. Some place for them to go now that quarantine is over.

All comments are shown as they were written and submitted by the respondents, and are numbered in the order they were received.

Q7. Please tell us your ideas, needs, and suggestions for the city community programs and classes.	
50	Free swimming lessons for Menlo Park residents. More open swim time for families. Reasonable pricing for swimming so families can afford to swim. Eliminate the programs we do not want. Consider public safety programs aimed at educating the community. For example, run programs on how to make (inexpensive) indoor air filters or how to use a fire extinguisher. I also do not see programs aimed at the residents living in Belle Haven. For example, start a "family time" where there is something for the whole family with entertainment for kids, enjoyable couple time for parents and even a simple dinner. I also think that MP should end it's public-private partnership with a for-profit pool operator who puts his paying students ahead of residents.
51	Having lived here almost a full year I'm not up to speed at all what the City offers in terms of programming. Would love to know more and excited to learn more to be more involved in the community for my family and kiddos. Would love to be added to an email list if one exists. Also has there been thought given to incorporating any sort of announcements (kid related) into the school newsletters?
52	Larger library budget for acquisition of both hardback and e-books.
53	City programs and classes should reflect the needs of the diversity that exists in the City of Menlo Park (more than just Dance).
54	We have two little ones and would love to see the gymnastics center open again as well as more swim and affordss as me athletic programs for their age group.
55	The dog park at Nealon is a fabulous community resource. How can it be improved or hours extended to encourage fewer off-leash dogs elsewhere?
56	We're interested in children's theater & gymnastic programs + table tennis or tai-chi for seniors
57	Aqua wellness/aqua therapy classes for seniors without class space reduced for children and lap swimmers plus taught by knowledgeable experts in that specific field.
58	My family and I really love Menlo Park and feel very safe in it, but there are a lot of things to be done, a free gym or athletic center for the community, outdoor events and celebrations for the whole community, gatherings, bbq, 4th of July is coming up so there should be something for everyone in Menlo Park to gather and celebrate
59	The gymnastics program should reopen.
60	My children participated for many years in the gymnastics program, and we were incredibly grateful for it. The instructors were generally very good, and my children thoroughly enjoyed the classes beginning with mommy and me classes and ending with competitive team participation. The gymnastics program, in my opinion, is a highly valuable program offered by the city.
61	BRING BACK GYMNASTICS FOR TODDLERS AND PRESCHOOLERS. It's crazy to me that Menlo Park has yet to bring back this program and found a way to adapt during the pandemic. We have instead used more community resources from Palo Alto. Much more impressed with their community resources.
62	Please begin hosting summer concert and activities again!
63	There is a park on willow oaks that has 3 tennis courts it will be great if one of them is converted to 2 pickleball courts. That will engage more people to come
64	Please bring back gymnastics! HUGE gaping hole in Menlo Park right now!! :(
65	Please open the gym for the kids! It's world class facility and it's just sitting there unused. What a waste. There's no reason why it's not open when everything else is open.
66	The aquatic exercise classes, taught by Sheralee Beebe, are valuable to people who have disabilities or whose advanced age makes other kinds of exercise impractical. I attended the classes at Burgess pool for two years before the COVID-19 pandemic hit. The program in Menlo Park is still not available for me, so I go to aqua fitness classes in the Palo Alto YMCA.
67	Bring back gymnastics!
68	More outdoor programs eg. Storytime at the library can be in the courtyard instead of indoors. Outdoor dance/martial art classes etc.
69	Tennis courts have been impacted by pickleball. Any expansion of pickleball courts should not be at the expense of tennis.
70	I worry that when my 7 yo is a tween/teen he will have nowhere to go and hang out with friends if he's not on a sports team or wants to hang at the skatepark. Why not take some of the vacant space on Santa Cruz Ave and turn it in to a STEAM hangout for kids with a juice bar, music space etc...like a modern teen center. Older kids could work there and be paid too. There could also be an area for bike repair. So many kids bike to Hillview. Kids need constructive places to gather. And what about programs for kids that take them outside the city on a hike, whitewater rafting, fishing etc..
71	I'd like to understand what outside groups are using the fitness facilities (Ariaga gym, pool) so that I can use the facilities through their programming if the city programming doesn't fit my schedule. A good example is the early morning fitness at the gym. I don't see that listed on the class list but I see all sorts of groups when I run past the gym in the morning.
72	Warm water (92+ degrees) aquatic therapy pools, handicap accessible.
73	I was an avid attendee to the former Aqua Wellness Program for years. We had an excellent teacher who kept us moving forward even though we were aging! The present programs are geared to the younger population with focus on intense cardio movements. The new program led by a physical therapist has its place, but should NOT be considered a replacement for Aqua Wellness. If we need that intense of a program we would be attending, but we are not severe yet nor can we afford it on a fixed income.
74	We are in need of additional pickleball courts at Nealon. The pickleball courts are packed while the tennis courts are empty
75	Sharee was very helpful to me when I needed aquatic rehab.
76	Create more pickleball courts to establish a community feel for Menlo Park. Allow more hours for pickleball (as opposed to tennis) to allow for pickleball programs and classes/clinics.
77	It would be nice to have facilities for cooking classes at the recreation center. Running, biking, hiking groups would be nice. And maybe other group activities - like surfing, paddle boarding, rafting
78	Everyone in my family cannot wait for the kids gymnastics program to restart. I would utilize Spanish classes and think it would benefit a lot of community members (or if not a class, then a meet up with people to talk in English/Spanish and be mutually beneficial)

All comments are shown as they were written and submitted by the respondents, and are numbered in the order they were received.

Q7. Please tell us your ideas, needs, and suggestions for the city community programs and classes.	
	- Arrangement for Belle Haven families to have access to swimming during the 3-year closure of their neighborhood pool. - Open swim time for families on weekends - Group swim lessons vs. private lessons - Open access to lap swimming in the Performance pool (early morning and evening) so that people who work during the day and can't afford Masters can continue to swim - Limiting rental to other organizations at least until 2023 when the new MPCC opens - Reasonable pricing so all Menlo Park residents can swim - Menlo Park should take back ownership of the pool and end the arrangement it has with its for-profit contractor that has been crowding out public access in favor of private programming.
79	
80	Two public run swimming pools at more affordable rates for residents as we used to have
81	Don't let third-party providers run the programs primarily for their benefit; focus on serving Menlo Park residents. Fee differentials for residents and non-residents should be substantial (like, double for non-residents)
82	I'd love to see a ceramics class where you can use a pottery wheel. There aren't many around here, whereas you can often find other programming, like music, at other places.
83	3 that Tim Sheeper/Menlo Swim continues into the future managing the swimming pool and it's programs. He and his staff do an outstanding job not only on maintenance but providing a variety of programs servicing all ages and skill levels
84	More fitness classes, more arts and crafts
85	Pool exercises in water shallow enough to touch shoulders for walking and stationary exercises. More senior exercises.
86	To include nearby East Palo Alto residents
	Upon moving here I was surprised by how few classes are offered via parks and rec, and how few community events there are. There should be a wide variety of classes for kids, adults and seniors. These classes can be run by different community organizations, companies and individuals. San Carlos and Redwood City have a much wider variety of classes than Menlo Park -- as well as wonderful community events -- and would be good cities to emulate.
87	Please also bring back musical performances and other arts performances.
88	Being a family with small children, we would be excited for programs geared towards families & children.
89	I'd love to see the entire gymnastics program for kids open up again. It's a hugeummer we don't have it in Menlo and residents need to travel to RWC or Sunnyvale to get them.
90	Appreciate all fitness classes for adults; also tech classes. I'd like to see classes on using iPhone for photography and video - for beginners.
91	would like a well-thought out informed strategy for pickle ball courts, which are used by people from as far away as San Jose.
92	make pool more accessible to the whole community-private lessons are given preference when this is a community pool; get the gymnastics program back. this was a very valuable program for our kids and I talk with many parents who want it for their kids
93	We NEED more pickleball courts. I don't know how many years have to go by to get something done. The courts we have now are always busy and the nets are falling apart. Please add more courts, the tennis courts are rarely used.; I am filling out this survey because the community needs more pickleball courts. thank you.; Nealon Park has only four courts and the tennis courts right next to the pickle ball courts are, most of the time, unused.
94	More Pickleball courts! Nealon Courts have had the most positive neighborhood impact of anything we've experienced yet!
95	Increase Pickleball Courts!
96	Pickleball becoming very popular. Courts are important.
97	Permanent Pickleball courts are needed.
98	Dedicated pickleball courts and more dual tennis/pickleball courts, especially at Nealon Park
99	My passion is pickleball. Earlier this year I used to play it 1x or 2x a wk at Nealon Park but I got discouraged by the crowds there. We need more pickleball courts in Menlo Park. Thank you!!
100	I love the way pickle ball brings together people of all ages. If we could have more pickle ball courts that would be great.
101	I believe pickleball is the fastest growing sport, it's quick to learn, inclusive and very social. Each city should have courts.
102	would like more pickleball courts
	Low Burgess but dressing and shower frailties for women are way too small for all the users. Actually need deprecate pool for lessons, summer camps and classes, the pool gets so much more use than any other piece of the open park area, baseball fields etc. More pickle ball courts Class times are geared to working people as they are scheduled in the early morning, lunch and evening, nothing for seniors mid morning or afternoon. We don't want evening classes. What about a servie that matches seniors to volunteering to assist with classes, camps etc, not just the senior center.
103	
104	Guitar classes!
105	There is an increase of older people to play sports such as pickleball. We need more courts available. Thank you
106	Pickleball classes for all ages
107	I would like to see more Pickleball Courts. The Tennis Courts are often empty, but people are waiting to use the four Pickleball Courts in Nealon Park. The nets in the Pickleball Courts at Kelly Park are in need of repair or replacement.
108	We need more permanent pickleball courts. I play 4 to 5 times a week and am forced to go to neighboring courts as Menlo Park does not have enough.

All comments are shown as they were written and submitted by the respondents, and are numbered in the order they were received.

Q7. Please tell us your ideas, needs, and suggestions for the city community programs and classes.	
109	I'd love pickleball classes
110	Keep the name of Onetta Harris for Belle Haven new Center on Terminal
111	regular in-person teens socializing programs, inclusive programs (especially of people with disabilities), lower-cost recreation programs for toddlers, children, and teens in Menlo Park, sibling discounts
112	Pickleball classes.
113	Bring back the gymnastics program for young kids. I've heard great things and my daughter has been waiting to try it. Green spaces are important, especially with shade.
114	Swimming/improvement lessons for adults.
115	You're doing a great job - thank you.
116	I'd love to see more big community gatherings. Movie nights, music in the park, art festivals downtown, maker spaces at the library.
117	There is a need for an open gyms at both community centers with equipment for exercise & low fees for usage.
118	Expand and improve pickleball courts.
119	This past school year, i wished that there were more swimming lesson options during after school hours. Now, i understand the swim team that meets at Burgess has a lengthy waitlist? If there were an option to expand via staff (if it isn't a facility capacity issue), that could be worth attention! We have also been waiting, along with many other kids' families, for the excellent gymnastics program to come back! Thanks!
120	Would liee to see the grassy areas open during the summer and fall months. At this time they are fenced off for reseeding.
121	Art studio classes
122	Cafe at the library
123	I would love to see the gymnastics for toddlers to come back. We've never been able to use this resource and I heard it was amazing
124	Remember that the parks belong to the residents of Menlo Park and not just organized soccer groups. The parks seem to be surrounded by orange mesh most of the year for restoration. Local residents who like to play in the park, visit with neighbors, walk their dogs, etc., can't use the parks most of the year. As for community classes, there are many low income residents who can't afford to take classes. Making the classes more affordable would be great. Also, don't forget about the adults and seniors. Seems most classes are geared towards children. Remember the tax payers.
125	Downtown fairs and events are always wonderful. Would be great if there were movies in the park (like in Redwood City) and more summer activities for families and all ages.
126	We want gymnastics back, kids enjoy that pre pandemic, now when everything is open it still has been closed. That's frustrating.
127	I'd like a makers space with tools
128	More events at the libraries or rec centers for babies/toddlers.
129	Continue providing services and get services that were closed due to COVID back up and running like the gymnasium.
130	Continue to support Menlo Swim and Sport programs
131	I can't speak to how important these classes are. They all seem to be important. Are people taking them? I'm sure that will be evaluated.
132	Please add more options for pickleball use. It is a wonderful way to bring all facets of the community together.
133	The city should endeavor to enable and seek out local Menlo Park contractors for resident programs. The city should work in conjunction with the school district, to organize a competitive sports environment for kids in school by hosting city championships in various disciplines as well as hosting city events for adults. Too much favor is given to outside contractors from other cities who are not invested in our local community.
134	More Pickleball courts and activities and communication, like Foster City and Palo Alto do.
135	Please reopen the gymnastics center
136	pickleball classes
137	I would like to request the permanent conversion of courts #3 and #4 to pickleball in addition to court #5 being kept for dual usage
138	I hope we can have group swimming lessons for children again. We can't afford privates. And can we please reopen the gym (gymnastics programs)? That was a treasure. The loss of swimming lessons and gymnastics because of covid has very much impacted our family and other parents in our community. Covid restrictions seem to have made the public space less accessible in general to families who are not wealthy enough to hire private teachers for everything. Please re-open if possible. Thank you!!
139	new in the area so i say the library is the perfect place to meet new people and know more about the area
140	Pickleball classes for new players. Many of us got introduction to pickleball from the Palo Alto City classes. Also, Intermediate classes for pickleball.
141	I have older kids that no longer live at home. I have never been impressed with Menlo Park's programs. We've typically driven around (when kids were younger) to do other programs outside of Menlo Park. I have recently started playing Pickle Ball at Nealon Park. Would LOVE to see some more tennis courts get converted as the PB courts more busy than Tennis.
142	We hope to have a big pickleball court . So people do not need to go to Palo Alto playing everyday
143	Love to have more pickleball court space
144	We need more pickleball courts vs tennis courts. One of the fastest growing sports in America and certainly on the peninsula.
145	More pickleball courts. They are full many hours a day! High school students thought senior citizens!
146	More pickle ball courts

All comments are shown as they were written and submitted by the respondents, and are numbered in the order they were received.

Q7. Please tell us your ideas, needs, and suggestions for the city community programs and classes.	
147	More pickle ball courts
148	More pickle ball courts
149	summer programs that are reasonably priced for kids, e.g., coding, gymnastics, swimming, acting.
150	Tener clases de inglés y que nos ofrezcan cuidado de niños al momento de asistir a clases
151	Exercise classes, physical fitness, gardening, discussion groups keep me thriving. Any possibility of a community garden in Menlo Park? It may interest folks who may wish to expand gardening opportunities beyond small patio container options. Thank you for the nice maintenance of the duck pond and park in Sharon Heights - it's my go to place for walking and relaxation.
152	Como cuidar el medio ambiente, usar material reciclado para otras actividades y minimizar la cantidad de plásticos en el planeta, como mantener limpia la ciudad, hacer campañas de limpieza por lo menos cada 3 ó 4 meses al año.
153	We enjoy live music at Fremont Park. PLEASE consider a complete, weekly schedule of music in the future. The pandemic has clearly impacted city events, but the live music draws residents of all ages and brings the community together in a safe way. This is the best way for us to get outside and enjoy the downtown restaurants. Thank you.
154	More community events. Look at Los Altos. They do an amazing job!!!
155	I've lived in four different neighborhoods of Menlo Park over the past 40 years. When my daughter was young, she enjoyed the dance and gymnastics programs for children. I participated in exercise programs for many years until an injury made it difficult. I love MP library and am often frustrated by the variable hours of operation- especially when the library was no longer open after my morning exercise class. I walk daily and find the lack of sidewalks not only frustrating but downright dangerous. The bumpy yellow patches at intersections may help some, but are a trip hazard for others of us. I wish we had more unpaved walking paths which are much easier than concrete on aging joints.
156	I walk the dirt path by the RR tracks on Alma almost daily because walking on concrete is dangerous for my feet prone to plantar fasciitis. I wish we had dirt walking paths where the trains didn't blow past. But it is lovely walk under the trees by the RR tracks. Off-topic: I saw a lady with grandson feeding the ducks -- right by the DO NOT FEED DUCKS sign. She couldn't read English but was very happy to learn what the sign says. You need that sign in several languages if you really want the ducks treated right.
157	Please re-open the gymnastics center or rent it out to those who can provide classes.
158	Pickleball classes
159	Cooking classes or demonstrations
159	Please open the gym. Also should prioritize Menlo park residents need and benefit first.
160	Please make the swimming classes more affordable for children who live in Menlo Park.
161	Please reopen gymnastics
162	Improve Access to Pickleball . more courts.. more hours.. and please cut the lock on the gate at the Pickleball court. It is a fire hazard / earthquake hazard to LOCK people in with only one way out. Be smart about this.
163	Would like to have ballet/dance/gymnastics classes for toddler or young children.
164	Please continue to invest in the Belle Haven community.
165	More dedicated pickleball courts
166	Release more pickle ball courts in Menlo Park
167	need a bench to sit on between games at Nealon Park Pickleball courts.
168	Community gardens. Outdoor festivals.
169	-Provide culturally relevant activities and programming. -Offer comprehensive services to the Belle Haven area. -Provide free/affordable service/programming to low-income residents.
170	Teens have very little to do in MP or the surrounding area. They tend to like to hang out in the evening and there is just nothing for them. In addition, Menlo Park is one city, not East and West, so ensuring equity of services is paramount.
171	More pickleball courts!
172	suggest to add more pickleball courts at Nealon park
173	More pickleball courts. How many pickleball courts can fit on a soccer field? Pickleball uses far less land, doesn't need water, pesticide, herbicide (although could be more green-friendly), used by ALL ages including families.
174	I think all of these are extremely important for the community and would be inclined to pay for/attend if available. ; I'd love to see free swim lessons for communities who need them.
175	Open the gymnasium which has been closed for 2+ years and run it at the same high level as the Burgess pool.
176	Please do not consider closing pool or changing current management. Many people know what the pool was like before Sheeper was running it. Swimming pools and programs are vital to a healthy community. Integrity will triumph.
177	We need to make MPO a more vibrant community - current programs except for those at Burgess are not good enough. And Why is the Arillaga Gym still closed?? oi kids cannot get access to gymnastics
178	More availability for community use of pool
179	Parents of young kids (2-5) need local options for gymnastics, soccer, and ballet.
180	pok'
181	Different martial arts, flag football, hi-5 sports programs, more swimming lessons
182	We have been waiting for the Gymnastics program to start up again. The only other gymnastics program in the area (in redwood city) is very full with long waitlists. It's so convenient to have gymnastics through Menlo Park and it's unfortunate that it hasn't opened back up yet.

All comments are shown as they were written and submitted by the respondents, and are numbered in the order they were received.

Q7. Please tell us your ideas, needs, and suggestions for the city community programs and classes.	
183	It seems like compared to neighboring cities, Menlo Park classes, services and events have not come back or take much longer, even outdoor options, which has been disappointing. I have a 5 year old and after living here for a decade, it now seems like he may age out of the ability to take advantage of the gymnastics offerings, which also have not come back. Local parent and neighbor Facebook groups complain about this often.
184	We would highly appreciate an inclusion program that can support inclusion of children with special needs in the Menlo Park after school and camp programs (similarly to the assistance they get at school)
185	Kids gymnastics
186	I'd like to suggest that the City Council, if they have not yet, survey other municipalities in San Mateo County, and see how other aquatics programs serve the needs of the community. My guess is that "the squeaky wheels are getting grease" in the current situation at Burgess. Residents who are happy with the programming are not so likely to let you know as those who have complaints. I was an aquatics professional for 30 years. I have done the work that Tim Scheeper is doing and I can tell you that there are few programs in the country that provide such diverse programming and give opportunity to so many people. It's not an easy job and certainly more difficult when the support of the municipality is not behind you. I strongly urge the city council to look on the bright side of what is being offered to the community. Having been the professional who was squeezed out of space by those "squeaky wheels" myself, I can comment that it is likely those people who are complaining will probably not attend often anyway and those who are being disenfranchised will lose their opportunity. The pool would sit empty is my guess. Water is a precious resource. Better to have the pool occupied and scheduled for activity rather than giving those who MIGHT show up more opportunity. The team at Burgess knows how to maximize the space and time. Even those squeaky wheels have time allowed for their use though they may not choose to go when the time is available. I would love it if my swim practice was at 10AM. I retired now and it would be my best choice. But I go when the time is scheduled for the programing I participate in. Seniors, families and disabled should do the same. That way everyone has equal opportunity.; Team Scheeper is doing a Jam up job!!
187	Dance classes, chuldren's arts and sport classes, music concerts
188	We have been desperately waiting for kids programs and gymnastics to come back
189	More space in children's sports activities, they're always waitlisted. More slots in swim classes, we've been trying to get in for over a year. Maker space for other creative training.
190	Options for mothers to get together with young babies or kids!
191	We would love to see gymnastics reopen and the pool continue to be use for recreation, camps, and swim teams.
192	First aid for all ages
193	It's time to count unincorporated Menlo residents as residents. It is the biggest factor in my family avoiding classes and the pool.
194	The gymnastics program at Burgess hasn't been running since Covid began and it's time to bring it back. The facility is sitting empty, when hundreds of local children should be using it. It is ridiculous that the gymnastics program hasn't been reinstated.
195	These programs need to be restored to pre covid levels it is really a problem, when nothing is done for over a year or more once county restrictions were lifted.
196	Outside Zumba. Park exercise where you can show up. I've done this in other communities. Group to meet people.
197	more variety classes for adults (non-seniors) that isn't just dancing (art classes would be amazing!), and a real gym where residents can freely use weights, equipment, etc.
198	Love the new pickleball courts at the Nealon Park, amazing addition for our family. Please keep them! Would like to see more soccer fields for youth soccer and would like a better /larger swimming pool for families. It is dominated by lessons and crowded, would be great to have a larger one or more options to swim in Menlo Park.
199	walking clubs
200	We need the pool to stay open :) I'm also not sure if the survey is asking how important things are *to me* (and my family) or how important I think they are to the general community. Those are two different answers for many of the questions. For instance, below on the swimming question - my kids are out of swim lessons so they are not important *to me* but are 3 to the Menlo Park community and I support them. I'm filling out the survey assuming that the questions are asking how important things are to the wider MP community, not just to my personal wants/experiences. For our family, there are enough private groups offering things like singing lessons and soccer and martial arts that we haven't looked to the city to meet those needs.
201	We took years of lessons at Burgess and now have two kids in swim team there and I reguarlarly swim laps.
202	Need more wellness and arts programs for seniors and teenagers.
203	Develop a park at SGI! Lots of people walk more now post- pandemic, and many got dogs. Pickleball is blowing up. This should absolutely be included in the Flood Park renovation!! Gymnastics at Burgess needs to be scaled way way up once it reopens. There is so much pent up demand for our little ones that have never had a chance to do it with COVID's impact. We can't even get ON a waitlist, local classes are SO full. Did I mention pickleball yet????? :)
204	I regularly attended adult gymnastics and Circus Aerials years ago, and would like to see this return. It would be great to see Menlo Park consider adding a disc golf course to one of its vacant green spaces.
205	It would be nice to bring back the gymnastic program. It was such an amazing program for the kids.
206	None

All comments are shown as they were written and submitted by the respondents, and are numbered in the order they were received.

Q7. Please tell us your ideas, needs, and suggestions for the city community programs and classes.	
207	Tim Sheeper has dramatically benefited Burgess and the entire MP swim program and community. All ages, all levels of athleticism. He took it from an under used program that was failing economically to a profitable Program so heavily used that people complain that they are comparatively under served. The problem now is too much success and popularity and the call for more services. Tim's success should be supplemented rather than punished.
208	I use the Burgess Park Pool and have for many years. My children participated in swim lessons, swim team and swim camp there. I value the Burgess Park Pool as an important aquatic resource on the peninsula. The Burgess Park pool is exceptionally well run with a wide range of programming for youth through seniors. The pool area is clean and safe, the staff is friendly and well trained, the availability of lap lanes is good. Many people depend on this resource for health, fitness and children's water safety
209	I would like to see more computer skills classes.
210	We raised our kids taking swimming lessons from age five, Menlo Maverick's, swim team, Camp Menlo summer camp, aerial silks, fun free swimming, lap swimming, and masters swimming for the past 12 years.
211	I formerly lived in Menlo Park for over ten years and then joined the Menlo Masters Program. I have swum with Menlo Masters for over 13 years and dearly love the program and want it desperately to continue.
212	All programs are essential to keeping Menlo Park an outstanding community. Reduced fees for residents is critical. Non profit organizations that can increase access to programs for underserved communities of Menlo Park should continue to be utilized.
213	The circus program at the gymnastics center is the most important and the one that is most important to our family and the most unique to Menlo (aka attracts people from the outside).
214	More pickle all courts, please. Also, a dog park for smaller dogs.
215	We need gymnastics open for our kids, Burgess playground it looking a little shabby lately, the library hours need to be extend to open earlier, more classes for toddlers
216	Guided walks, gatherings where people can work on crafts together (not teaching, just doing), a way to link language learners together (i.e. I am learning Spanish with Duolingo, but would like to meet someone my age to chat with and improve my understanding and fluency)
217	PLEASE PLEASE We would LOVE to see the Arriaga Gymnastics class for toddlers/childrens come back.
218	We need a beautiful dog park. With grass and large expanses to run and play. The Willows dog park is subpar. If the field next to the school were available the community would come out far more than they do now. I would venture that more than half of the non-dpg households have gotten a dog in the last two years. This needs to be vastly improved.
219	I don't participate in many community programs anymore but I do think they are 3 for the community. I would also like to see more mixed age programs, for instance Dungeons and Dragons, for seniors/adults/teens, and not just offering programs to the age group we conventionally associate with that activity. I also think the community will benefit from interacting with all ages and not conforming to agist stereotypes.
220	recreational gymnastics, working (repaired) playgrounds, classes for special needs, classes, support and open space for home schoolers.
221	please bring back softball, widen basketball appeal
222	There are dozens of new residents in BH and we all meet while walking dogs and our dogs want and need and deserve a good dog park to play in!!!
223	My fear is that people of color may not feel welcome because our community has changed so much. There must be a way to help long term residence to feel that it is still our community.
224	Classes for all, students, seniors, adults, families, children of all ages
225	Free classes for residents
226	Belle Haven--Senior \$ management classes, low income housing education, pet laws + county licensing opportunities brought to community, golf
227	Beginning hula and Hawaiian huna healing (ho'oponopono)
228	Bring back the gymnastics program, PLEASE! It was awesome and the kids all loved it. Even my 8 year old keeps asking for it.
229	It is very sad that playing tennis is so expensive in our city.
230	Kids love soccer Toddler/young kid tennis
231	More community-building events, like Redwood City does
232	Love to have more cooking classes like cheese making! (Cheese making will be a huge hit at Menlo Park)
233	I would appreciate more Pickleball courts. It's both social and exercising in one. It's so easy on the body, playing on smaller courts using a wiffle ball - Very good for the soul. Everyone should do it, but there are so few courts.
234	More pickleball courts
235	Please install more permanent pickle ball courts! Thank you for being willing to get community feedback
236	more pickleball courts are needed as the demanded continues to rise!
237	Creative classes for seniors
238	More pickleball courts
239	Would like to see more pickleball courts available
240	Beginning pickleball should be taught. Clad would fill quickly. Also intermediate PB
241	More pickleball courts, please!
242	More pickleball courts it's good for all ages and it brings the community together. It is a growing sport. It benefits health. We are a member of the Palo Alto pickleball club which has over 700 members. Othe communities are having more pickleball courts. The courts could be used for tennis as well as pickleball. There are people that play both. Thank you
243	Pickleball. Needs more courts. It fits all ages. Community builder. Terrific future

All comments are shown as they were written and submitted by the respondents, and are numbered in the order they were received.

Q7. Please tell us your ideas, needs, and suggestions for the city community programs and classes.	
244	Add more pickleball courts. Give lessons for residents/non-residents.
245	More pickleball courts, please.
246	I play pickleball everyday
247	Contract the pool and gymnastics- do not run in house
248	More senior programs in the afternoon.
249	Sewing (beyond beginner), toddler gym
250	More dog parks and pickleball courts!
251	no idea
252	We need more pickleball courts please. They are used by so many all the time and bring together 6yr olds to 86yr olds 😊 it is good clean fun which brings so much joy to so many
253	It would be great to have more robust Pickleball offerings!
254	More pickleball courts!
255	It would nice to have Spanish speaking lessons available in Menlo Park.
256	I would like some pickle ball courts on the west side of MENLO Park, Closer to my neighborhood.
257	more flat areas
258	Culture exchange. Mental Health. Family relationship building. Arts & Music. STEAM.
259	I know Palo Alto has priority for MP residents when enrolling in classes hopefully MP can implement something similar.
260	We need to get the pool with more activities for kids and after school sports.
261	I don't hear much for free courses or at least pay for a class such as art, dance, or any other that is given on weekends. Also would be helpful to have on hand a magazine with all activities.
262	More recreational facilities for classes on dancing, pottery, art & crafts
263	Please bring back all the dance and sport activities for children
264	Table tennis, badminton, dance classes
265	Belle Haven needs same access and perks as the West Side MP. S
266	-Blinking lights at crosswalks! -More local art! If not murals, an opportune place for people to show-case! -A better wide-spread newsletter. It's hard for Belle Haven residents to know about events.
267	Thai Chi for seniors
268	Que nos den clases a los adultos. Gracias
269	community college campus
270	Have more activities for kids, After School Programs. Wood shop, music classes, basketball, etc. Need supervision. Have the suggestion what they like and want to do.
271	More daytime dance classes for adults such as Zumba, hip hop, jazzercise etc.
272	My husband works at Bay Club so we are fortunate to have our fitness + some community needs met there.
273	toddler gymnastics classes
274	It would be great to have a free fitness center.
275	We should honor the diversity in our community by having community gatherings in the community center for all; We should use this new center for everyone in our community instead of allowing outsiders to rent or use or fields for sports Bellhaven residence should have priority
276	I would like to see a variety of equity & inclusive involvement of Black people and programs throughout Menlo Park.
277	Please make the charge to use the swimming pools very low for residents. I don't use the pools because the fees are to high. Lessons for the kids in Belle Haven should be free! It saves lives.
278	Gardening, growing vegetables, fruits, etc
279	I was not fully fully aware of availability and other details of classes
280	More green space, outdoor play, gymnasiums, pools
281	Still don't feel that safe w/ covid doing indoor clases - outdoor yoga? zoom classes? more language and art offering, how about a menlo service orientation class?
282	Aqua swim programs core classes
283	maybe community cookouts/bbq to meet residents. Community garage sales. More free or discounted things to bring the community together.
284	It's 3 to offer similar classes that are held at West Menlo Park. It's also important that rates remain similar to Onetta Harris prices. Affordable for the community that live in Eastern MP.
285	Plaza should be nice. Shopping outlets. Malls
286	I'd love to have pickleball courts in the parks!
287	Maintain green areas and mature trees, particularly natural spaces (of which MP has very little), don't replace them with built environment, including hard surfaces or plastic coverings.
288	food preservation classes, local history/culture, welding and metal crafts, and acting/theater
289	hindi class for children, kid's soccer program, kids swimming classes
290	very excited for new kelly park construction to be finished! maybe a little more information at track about what's to come!
291	I'D LOVE TO LEARN AND PLAY PICKLEBALL! WHAT I HEAR IS THERE ARE VERY FEW COURTS AND THEY ARE VERY BUSY. ALSO, I'D LIKE TO FIND INSTRUCTION . MANY PEOPLE I TALK TO ARE INTERESTED IN LEARNING AND PARTICIPATING IN THIS ACTIVITY.
292	Pottery open studio please

All comments are shown as they were written and submitted by the respondents, and are numbered in the order they were received.

Q7. Please tell us your ideas, needs, and suggestions for the city community programs and classes.	
293	estate planning education
294	It is 3. You did a good job for the city community programs and classes. It is 3 to me.
295	English classes
296	English classes
297	cheaper housing for seniors
298	We only recently moved to Menlo Park from San Mateo. San Mateo had a great parks and rec program for taking classes for the kids. Would love to have recreation soccer, baseball, basketball, tennis and swimming opportunities available for the kids (5.5 and 8 years old). The kids go to school in a different town, and would be a great way for them to meet other kids in the community.
299	affordable classes for youth/adults. More times for working parents
300	Terapia de arte Clases de natacion para adultos clases de yerrios
301	N/A
302	No es buena idea que trabajen o ayuden mimberos de la misma familia
303	Que tengamos lases para las personas, que no sabemos leer, y unas clases para las personas de la tercera edad que no sabemos escribir y que respete.
304	I would like to see more library program for teens, especially ones focused on arts, crafts, etc. Also, please start offering classes for teens from Academy of Design: https://www.academyofdesignsf.com/ .
305	When will the gymnastics for kids restart? This was great!
306	Please do even more to support tweens/teens with free or heavily subsidized activities they can do on Fri/Sat evenings. Board game night, D&D night, etc. I am willing to help with this so please reach out to me if you want help!
307	Due to covid, I think things have to be offered online. A lot of people that are older are also still working so it would be great to have classes outside of typical work hours.
308	Para mi todo lo que enseñan me gusta los niños aprenden un poco de todo cada día
309	no tengo comentarios
310	Currently just have lack of information about community events. Belmont mails out notices or packet explaining offerings for the season.
311	Would love to have more info on these programs more accessible to the community. It would be nice to get a letter/email sent w/ all upcoming activities/classes for the month/year!
312	Exercise classes for after work hours. Many classes are during the day when I'm at work. Would love to participate if there were evening and weekend scheduled classes.
313	Create useful programs that are needed for young children and adults.
314	Having educational for the youth & teens. Job skill programs & training
315	Would love to see a rec center with a heated pool for elderly to do walking. And as much free for those of us living < the poverty line.
316	Offer digital classes, certifications would also be great to use towards resume
317	Children's & teens activities would be great for the community. Senior also but most may not be able to get there
318	I would love for there to be programs to create social spaces for parents with young children. For new parents especially this can be a nice way to build community with other folks in a similar life stage. Seattle, Washington has a program like this and it is very highly regarded. Perhaps Menlo Park can facilitate these social connections? It wouldn't require many city resources to implement, except for some administrative support.
319	Programs for small kids (under 2)
320	More civic centerswith affordable prices for the commy.

All comments are shown as they were written and submitted by the respondents, and are numbered in the order they were received.

Q8. How important are the following aquatics and swimming programs?

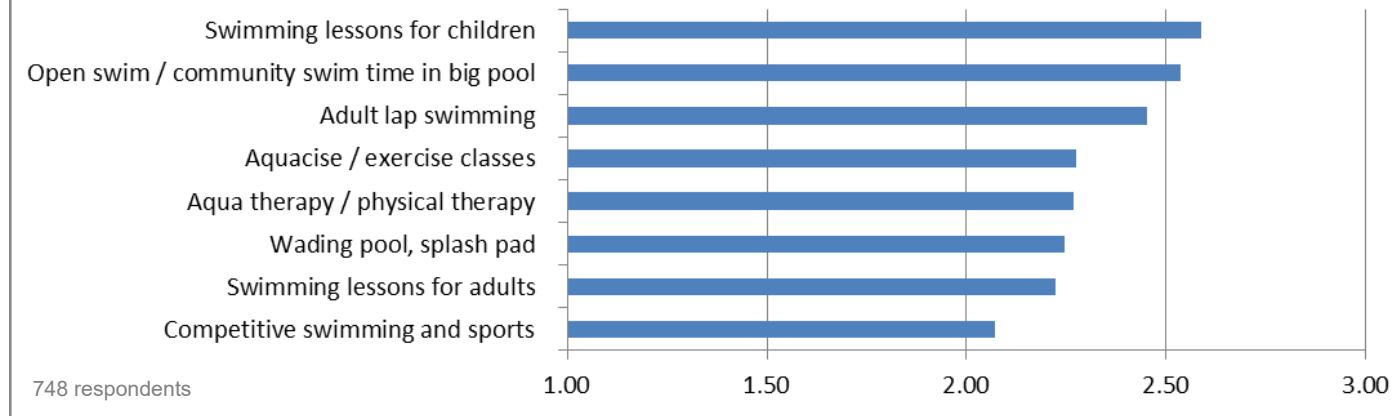

This chart shows average relative importance as rated by survey respondents. Respondents had the option to rate each item as either "not at all important," "somewhat important," or "very important." Items rated "not important" are assigned a value of 1; "somewhat important" a value of 2; and "very important" a value of 3. The chart shows the average value of all ratings for each item. Higher average ratings indicate higher relative importance to the survey respondents.

Q9. For aquatics and swimming programs, how important are the following items?

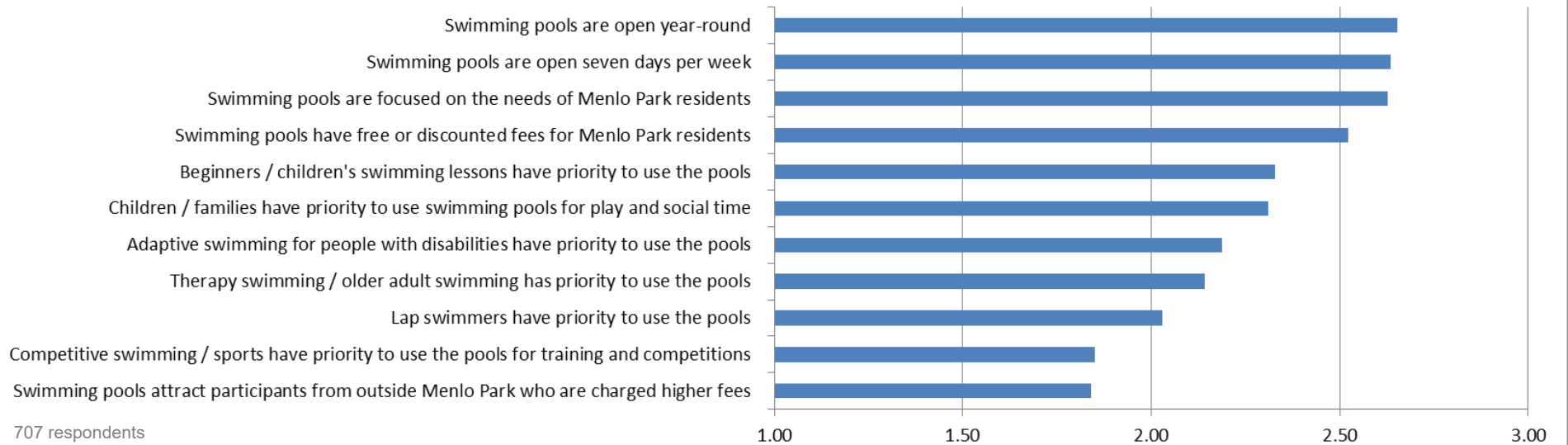

This chart shows average relative importance as rated by survey respondents. Respondents had the option to rate each item as either "not at all important," "somewhat important," or "very important." Items rated "not important" are assigned a value of 1; "somewhat important" a value of 2; and "very important" a value of 3. The chart shows the average value of all ratings for each item. Higher average ratings indicate higher relative importance to the survey respondents.

Q10. Are there any changes to the city aquatics and swimming programs that would make you use them more often?	
1	As stated above, the new scheduling system is awful at Burgess. It is almost impossible to get a swim lesson and even if you get one that's usually it. There's no consistency unless you have the ability to sit at your computer and wait for when they open on the dot. It's not equitable to those that can't do that, don't have help with scheduling, work full time away from a computer, etc.
2	Longer hours open lap swimming before or after work
3	More open times for Menlo Park residents
4	Longer hours and open year round with better hours for working families, reduced fees for teachers
5	More beginner swimming lessons for kids
6	More open swimming
7	Yes! We would definitely use the pool more if adaptive swimming was available. There is a huge need for it in the community with years long waiting lists that aren't moving because there aren't facilities available. Water exercise classes for adults and seniors would also be great.
8	My family trying to do lessons for a short period of time. Each time we came, the instructor was different so I had to keep explaining to them my child's skills and because there were multiple kids in the class, the instructor really barely got to know my child and I felt like it was a waste of time
9	0-3 infant and toddler classes
10	Good and clean locker rooms. Warm pools
11	- family membership (monthly or annual) is needed - open swim for children 7 days a week for multiple hours, year round, not just summer - baby pool open 7 days a week, year round
12	Tim Sheeper has done an amazing job in the past managing the Menlo Park community pools and I truly hope Menlo Swim and Sport will continue to operate the pools offering a wide array of programs to a diverse number of people.
13	No
14	Current programming is excellent, accommodating a wide range of users in equitable fashion.
15	More swimming master's programs.
16	Several. The pool has become a profit center for Team Sheeper to the exclusion of the community needs. There should not be teams such as PASA (Palo Alto Stanford Assn.) using the community pool. This activity belongs at Stanford, School pools or Country Clubs, not Burgess. Sheralee Beebe's senior exercise classes were very popular and even oversubscribed, yet Sheeper cancelled them for personal animus and replaced with a so called physical therapy class that charges double the cost. There is altogether too much emphasis on elite athletes who come from other areas, some far from MP and who are charged substantially less (hour by hour/lap availability) than the community activities. Also, the baby pool is under utilized and infants (often screaming) are "taught" on the steps of the warm pool, blocking access for disabled people. There are no ADA doors. There have also been incidents where kids have pooped in the pool causing everyone to get out. The locker rooms are also often blocked by strollers because people do not use the family locker rooms. There is an Aqua Fit program but that is not something that older or disabled people can participate in. Ideally the baby pool should be reconfigured and reconstructed to be used exclusively for small kids so that they could be safer, watched more closely, so that there would not be so many accidents. Also there are problems with maintenance that seem to be caused by lack of appropriate attention. To have the warm pool closed for 8 weeks is astonishing. In addition there have been numerous short closures owing to various malfunctions. Apparently this is also the case with Rinconada, also "managed" by Sheeper. Sheeper's entire focus seems to be on the masters program and Team Sheeper expansion and not on the Menlo Park community's needs.
17	I feel all of the above uses of the pool are important. careful scheduling should be able to accommodate all. Weekends should have plenty of hours for family swim, toddler splash pool. Saturday mornings, programs for kids racing, learning to swim, socialize with friends. Reserve weekdays before 3 for adults.
18	water wellness classes similar to those taught before covid
19	Need more open lanes for lap swimming in instructional pool. Currently there is only 1 open lane during the afternoons during the week, which is the only time I can come to the pool.
20	If Burgess were to offer the same aquafit and aqua wellness programs as in the past, I would love to participate again. It worked quite well in the past.
21	Bring back wellness exercise classes at 9 and 10 am
22	Aquafit taught by Sheralee Beebe

All comments are shown as they were written and submitted by the respondents, and are numbered in the order they were received.

Q10. Are there any changes to the city aquatics and swimming programs that would make you use them more often?	
	Questions above are difficult to answer as I believe that no single 'demographic/audience' (e.g., competitive vs. children vs. families vs. senior wellness) should have 'priority'. My extreme disappointment is in the current Sheeper management approach, he has completely ignored the needs of older people who benefit greatly from whole body/aquawellness exercise (e.g., Ms. Beebe was teaching very successfully for the 3 years I attended 3days/wk). There are few alternatives locally for such exercise and, personally, my own health and mobility have suffered greatly from lack of options I enjoyed with Ms. Beebe's classes. I would plead for getting rid of Sheeper in favor of better programming orchestrated for families and also young and older. Now there seems to be a favoring of competitive swimming even to the point of having Stanford affiliated competitive swimmers being allowed swim time over the needs of Menlo residents. THAT is NOT what I'm paying taxes for.
23	
24	<ul style="list-style-type: none"> - Open swim time for families on weekends - Group swim lessons - Open access to lap swimming in the Performance pool (early morning and evening) so that people who work during the day and can't afford Masters can continue to swim - Limiting rental to other organizations at least until 2023 when the new MPCC opens - Reasonable pricing so all Menlo Park residents can attend - Menlo Park should take back ownership of the pool and end the arrangement it has with its for-profit contractor that has been crowding out public access in favor of private programming.
25	If the pool had lap swimming available for drop in residents, I would be thrilled!
26	More open swim
27	Better swim lessons- we have done the group lessons and the coaches just play around most of the time and don't teach
28	See above - lessons for infants/toddlers are main interest
29	We would love to see more private swim lesson times offered. We're really struggling to book swim lessons and to find space on a swim team.
30	<ul style="list-style-type: none"> - Open swim time for families on weekends - Group swim lessons vs. private lessons - Open access to lap swimming in the Performance pool (early morning and evening) so that people who work during the day and can't afford Masters can continue to swim - Limiting rental to other organizations at least until 2023 when the new MPCC opens - Reasonable pricing so all Menlo Park residents can swim - Menlo Park should take back ownership of the pool and end the arrangement it has with its for-profit contractor that has been crowding out public access in favor of private programming.
31	More family friendly, more affordable, more access outside of work hours
32	I love swimming and live near the pool but never go because of the fees and difficulty getting lane time. It seems like it's always occupied with something that has little to do with Menlo Park families swimming. Please consider taking the pools back from whatever contractor runs it and opening up to Menlo Park families. In contrast, we use the library three times a week and the basketball arena for school basketball teams. ; Longer hours. Less Masters swim. Fewer individual classes and more group classes. More "slow/beginner" lanes. Cheaper rates for city residents. Especially while other pool is closed.
33	More open swim times throughout the year. Family memberships!
34	More swimming space for families with young kids.
35	Same as above - offer physical therapy/aqua therapy classes for seniors that are taught by trained aqua therapy instructors without sacrificing the space in the pool for the classes. Would prefer deep water aqua therapy classes so children learning to swim could be in shallow area that we would walk through to reach deep water. Need to change direction of area pool dividers to create a big deep water area across the end of the pool.
36	Less expensive; Better advertising to encourage people to use the facility and make them aware of the various ways they can do so.
37	Ensure that the wading pool is open so that adults are not bringing toddlers into the instructional pool. There have been three incidents involving toddlers that I have observed because of this lack of wading pool availability.
38	Our family used to take full advantage of the open swim time, especially during the weekends. Several years ago, however, the pool started restricting the number of people able to swim at a given time, and we would show up only to have to wait in line for an indeterminate amount of time. We pretty much gave up going to the pool after being told to wait in line too often. But when the weather is hot, and I drive by the pool, I am disappointed that swimming there no longer feels like a bankable option.
39	No. The pools have the best programming and hours of operation in the Bay Area.
40	I love the water wellness program taught and supervised by the physical therapist

All comments are shown as they were written and submitted by the respondents, and are numbered in the order they were received.

Q10. Are there any changes to the city aquatics and swimming programs that would make you use them more often?	
41	More open swim / splash pad availability, and a season pass pricing option for families (\$28 every single time is prohibitive)
42	Bring back Sheralee Beebe to teach aquacise classes.
43	More open swim time!
44	Longer hours for family swim (Open earlier so small kids can use it since they nap in the middle of the day). Longer season for the baby pool, not just a couple of months in the summer.
45	Public swimming availability seems severely limited, especially on hot days...
46	The chlorine level is extremely high at Burgess.
47	I know lifeguards are hard to come by and that's limiting hours and activities that are available. I think it's important for the community to understand that and not just complain about the lack of hours.
48	I'm a disabled 49 year old. I recently had to join a private pool instead of swimming at Burgess 3-4 times a week because of lane availability. I'm only able to use the warm pool because I cannot manage the ladders. I had been at Burgess pool on several occasions when it was designated lap swimming time and have either been asked to leave my lane for a lesson (of course they will throw me out when lessons cost \$76 per half hour!) or they have allowed families and children to occupy the lanes (when it wasn't free swim). The facility isn't ADA compliant (slippery locker room floors and difficult to open doors). I'm glad I could move to a private pool but am concerned about the community members who can only swim for exercise and have extremely limited times and resources to do so. The community is not prioritized- Tim Sheepper is profiting off of this pool. It's ridiculous to pay \$76 for a 30 minute lesson also! When I learned to swim in SF, it was free to the public. Public swimming pools shouldn't cater to the wealthy elite. You are doing a disservice to a lot of the community.
49	Warmer water, some hours dedicated to handicapped / seniors
50	At the present time there is No Aqua Wellness Program. A program designed for seniors with a focus on balance, coordination, posture and over all movement and flexibility. Seniors benefit from the program pre and post surgery- of knee and hip replacements.
51	The locker rooms at Burgess are in serious need of upgrade both in terms of space and quality
52	Probably not. We are fortunate to have a pool at home.
53	We use them a lot already, but wish they splash area for little kids was open more during the year.
54	<ul style="list-style-type: none"> - Open swim time for families on weekends - Group swim lessons vs. private lessons - Open access to lap swimming in the Performance pool (early morning and evening) so that people who work during the day and can't afford Masters can continue to swim - Limiting rental to other organizations at least until 2023 when the new MPCC opens - Reasonable pricing so all Menlo Park residents can swim - Menlo Park should take back ownership of the pool and end the arrangement it has with its for-profit contractor that has been crowding out public access in favor of private programming.
55	Programs need to be administered and run by the city, not outsourced to a for-profit group that doesn't share the broader community's needs
56	More time for residents, less focus on non-residents. Current fee differential for resident/non-resident is trivial. There is no City oversight of the program is run (its all for Sheepper's benefit, not for Menlo Park's).
57	I use the performance pool often for laps and I really appreciate how accessible, clean, pleasant and available it is. It is always being used but it is rarely super crowded--I almost never have to wait for a lane/half-lane, lifeguards are always attentive and moving around, and friendly. This is a menlo park amenity that I really appreciate.
58	The aquatics programs that are now available have a huge variety of opportunities. These opportunities already cover the full range of what an aquatic program should offer. There is a really fair balanced offering currently of aquatic programs. I would not change a thing nor the current managers of the aquatic program as they have been doing an outstanding job
59	Yes. Having a shallow (4-5 feet deep) part of pool to exercise (no need for instructor.) Let residents sign up first, then out-of-towners as needed to fulfill numbers.; I don't swim laps anymore because I got kicked too often. Limit numbers in lanes. Extend hours of use. Build an olympic-sized pool!!! Keep fees smaller for MP residents and more for out of towners.
60	The pool staff seem to do a great job. Balancing the needs of the community is tough, but it seems that Burgess has a good balance.
61	I just need to learn more about the programs.
62	more community-wide access

All comments are shown as they were written and submitted by the respondents, and are numbered in the order they were received.

Q10. Are there any changes to the city aquatics and swimming programs that would make you use them more often?	
63	Too many people in the pool -- lanes are often full with 2+ people sharing which is difficult with many skill levels. Focus on incorporated Menlo Park residents who pay taxes to support the pool. There are too many programs and teams using the majority of pool lanes, especially after school and after work when residents want to swim.
64	I don't use them often now, but I did when my kids were young. I think they should be affordable and accessible for all MP residents.
65	Tell us us the annual operating costs in these surveys
66	Changing rooms are an embarrassment. Overcrowded so showers and spinner frequently breakdown. Many people won't go inside, or can't fit so they come an go from home. 1 family changing room, which is used by disabled persons with aides as well, is way to inadequate. Another pool is required for the number of participants. This is one case that i you build it they will come.; Expand and modernize changing rooms Add extra teaching/camp pools. Noise level & waves make classes and teaching in the same pool near impossible. Have city staff responsible for oversight visit every day. There is a lack of communication between departments so that repairs take months. I went to the city offices and spoke to two épatements about a necessary repair in the dressing room. Although pool staff said they conveyed the need city staff didn't follow=thru. The pool seems a low priority for city staff. Ensure there is always a user representative that is on the recreation committee The pool management is excellent so retain them.
67	Make them (pools, swimming lesson, lap swimming, etc) less expensive so that more people can take advantage of pool usage. Esp in the Belle Haven neighborhood.
68	Cheaper prices - \$9 from \$6 is a steep price increase for lap swim. The triathlon club is also incredibly expensive. Swim lessons are also very very expensive.
69	More aquacise classes offered in the evening
70	More open hour for families, more swim classes for children, priority for MP residents
71	More swim classes for kids and more open hour swim.
72	I would like to see more family and open swim time.
73	Group classes for children at lower cost (can't afford private lessons), especially in non-summer seasons; accessible options for swimming teen with disability
74	Ability to reserve/rent an area of the pool for private lessons with an instructor that we pick
75	Laps available for any swimmer at all times pool is open. Should not have to join MAster program to swim in early am
76	More available times for individuals with some disabilities. Warm pool restrictions so that regular lap swimmers do not take up the available lanes when bigger pool is fully occupied. Warm pool accessibility needs to increase for adults with individuals with disabilities during the daytime (esp mornings) summer time. Currently, swimming lessons for kids have priority.
77	See comment above about timing availability!
78	I thin k Tim Sheeper has done a great job balancing aquatic programs and managing the pool facilities
79	It's been very hard to get swimming lessons, even when you are able to book one, not having continuous progress (monthly/quarterly) lessons doesn't help kids to actually learn how to swim
80	More options for kids classes
81	Having more coaches and times spots to choose. I haven't sign my kids because you don't have enough people.
82	No
83	All of these programs are important. Group swim lessons are more important than private swim lessons. Youth competition, masters swimming important. Lap swimmers can have more people per lane to make the best use of our limited pool resources. Should be plenty of open swim on weekends.
84	I'm a longtime resident and have been happy with how Menlo Swim has been managed.
85	Please please keep masters swimming through team sheeper as it currently is. Tim does an amazing job
85	The swimming programs at Burgess have been an important part of my mental and physical well-being. The pool is well-run, clean, professional and a highlight of living in Menlo Park. They cater to a wide variety of individuals and groups. Nothing is perfect, and sure, there are times when I wish I had my own lane or something, but the quality of the pool and it's programs is better than any other that I have seen from visiting others around the area. I can't fathom that the city would contemplate wrenching away such a well-run pool from its residents.

All comments are shown as they were written and submitted by the respondents, and are numbered in the order they were received.

Q10. Are there any changes to the city aquatics and swimming programs that would make you use them more often?	
86	My entire family (2 adults and 2 kids) have been regular users of the aquatics programs for years, including drop in casual, Childrens swim lessons, Childrens competitive swimming including the summer league, bday parties, masters swim team, and adult lap swimming. The existing program is top notch and serves the needs of Menlo Park residents very well. It also provides jobs for local young adults and kids. During the pandemic, they kept programs going and provided an invaluable outdoor activity resource available to our community although it was extremely challenging to do so. The current management of the aquatic programs and pools is excellent.
87	No; None
88	no
89	I think the aquatics programs are great. I swim Menlo Masters, I play women's maters water polo, our kids did swim team at Burgess, lots if local kids get good jobs and experience at Burgess. I think Tim Sheeper and staff have done an amazing job utilizing the pool for everyone.
90	Please do not change anything. We have a great aquatics pool operation.
91	The free swim option for locals are limited and unwelcoming
92	mmm no
93	The City's aquatic programs are already great and I use them often. Please don't make any changes to the current operator or operations.
94	More swim lesson availability and consistency.
95	I don't use the pool, can't tolerate the chlorine for long periods..
96	No; No.; No. No. No. this survey will not allow me to continue. Is it designed by swimming people? Please let me finish the survey.
97	The pool times can be set for different priorities during different times of the day and different days of the week to accommodate different groups. It's not possible to have lap swimming at the same time as children and families playing in the pool.
98	Whoever runs the pool, please keep it open and available for the Menlo Park residents
99	Mote classes for children, more open swimming opportunities for families
100	More affordable swimming lessons for children.
101	The teamsheeper service that is used to sign up for lessons is very inefficient and not user friendly-- I always have trouble with it and have had to reset my password multiple times. Also we are begging for swim lessons as is every other family we know. We've never been able to get them, only a few privates. I feel like people are elbowing each other in the face to get to the lessons first by signing up right at 12:00, and everything is gone within 3 minutes. It's a terrible system and perpetuates inequity for those that cannot drop everything and sign up midday. Water safety is a necessity for everyone, we should better be able to meet the needs of more families.
102	I am a lap swimmer who would like to be able to swim after work 4-6. I would love some lanes open then.
103	I think it's important to figure out a way for all the users to have some time.
104	Proximity
105	Is there a summer pass for families? What kinds of programs are there for teens who might be interested in teams but are not ready to compete?
106	I will likely use Burgess if Tim Sheeper is in charge of the facility. If the city takes over and shuts down Menlo Masters, I will likely use another facility bc there probably will no longer be a team and I'm a competitive swimmer. I occasionally lap swim but I use Burgess, far and beyond, primarily for the Menlo Masters swim team.
107	Three rather than two masters swim sessions on weekday mornings.
108	Keep the pool open As many hours as possible looking Forward to the new Belle Haven pool
109	The Burgess pool has programs for all ages and needs. I am really impressed with how it is always full of swimmers and families, and how it was the first facility to be opened during the pandemic. I would not like to see any changes in the programs.
110	Integrity will triumph. Mr Sheeper is a man of integrity. He balances his passion and priority for community involvement with viable business needs & ethics. Menlo Park is fortunate to have such a person at the helm of this aquatics facility. He deserves more value & recognition for all his behind the scenes time, initiative and problem solving than what he gets.
111	Menlo Swim and sport is the best aquatics program Menlo Park ever had. I have lived in Menlo Park since 2004 and the pool hours were very unreliable before Menlo Swim and Sport started running it.

All comments are shown as they were written and submitted by the respondents, and are numbered in the order they were received.

Q10. Are there any changes to the city aquatics and swimming programs that would make you use them more often?	
112	The Menlo Park Swimming pool programs have been a benchmark not only for the bay area but for California for years, they serve the elderly, disabled, kids and competitive athletes in more ways than any other pool in the surrounding counties ; Every time i want to go there are open lanes and it is super easy to get in and out. I do not see the need for change; Every time i want to go there are plenty of lanes available, i do not see the need for change. MP pools are one of the few that operate 24x7 from 6 am to 9 pm every day.
113	Competitive activities belong elsewhere, not in a community pool. They should not take priority over community needs
114	Aqua Fitness and Wellness the way it used to be pre-pandemic
115	Any kind of infant/baby/toddler swim lessons on weekends. Everyone I know either gives money to La Petit Baleen or private clubs for this. It's a missed revenue opportunity.
116	More lessons, charges less
117	Swimming pool should be closed and heated
118	Our main focus is swim lessons for children. Group lessons are all booked and private lessons are much too expensive.
119	More family swimming time during the week and weekend. More group swimming classes for children
120	My experience of offering time for families and social time is that there will be minimal use. And when this is offered, there is more maintenance and upkeep required simply due to the nature of activity offered.
121	Longer hours in the evenings in the summer. We frequently want to go swimming after 6:00 p.m. more space for swim lessons, been trying for a year to get in. More family locker rooms so we can all shower and dress at the same time together.
122	Love the pool! Please keep it here!
123	Lounge chairs or more space for sitting would be nice. We just come for swim practice and leave. An open swim area or time (without lane lines) would be nice for just enjoying the pool.
124	Include unincorporated Menlo residents as residents
125	I would use them a lot less or not at all if the current pool management is changed and the city takes over the management of the aquatics program.
126	Tim Sheeper has a well run organization throughout my multi year membership and I was especially grateful during the pandemic. Burgess pool and staff have positive health benefits for the community.
127	dog pool maybe?? (dedicated small one), or dogs come on closing days
128	More lap and family swimming options and better rates for residents - ie closer to free or highly subsidized.
129	I used the kiddie pool and the large pool when I had small children. Once the pool became "private " we never felt welcome again and have never returned. My older daughter took swim lessons at Burgess pool but once Sheeper moved in we went to SCRA. Both my children learned to swim at SCRA. I was and still am livid that Menlo Park build this beautiful new pool for Sheeper. Why can't the City run the pool they did before?
130	community open house - introduce aquatic programs to citizens
131	We use the pool close to daily during the summer, and 3+ times a week during the school year. We are heavy users, nothing could make us use the pool more. I look forward to the Belle Haven pool being complete - it is closer to our home. Re: Therapy Swimming and Adaptive Swimming. I've never heard of a need for those - is that something the community is asking for?
132	In the past there was some limitations on time slots open to general swimming use before the pandemic so would like to see that during summer more hours open to the general public use rather than competitive program use.
133	Aquatics fitness drop in classes on weekends for adults
134	I'd like to note that Tim Sheeper has been running an excellent aquatic program that juggles the needs of many people who use the pool. It is amazing. I've never seen the pool empty. It would be a shame to try to fix something that isn't broken.
135	More time and more lanes open for open family swim
136	Increase the number of slots for swimming lessons so that more kids can learn how to swim.
137	More pool facilities to meet the size of our collective community needs. Burgess is great, but gets incredibly crowded. We have outgrown that one facility and need more space for families.
138	More lap swim times/lanes
139	More open swim hours.
140	Devote half the instructional pool for play .
141	Clearly defined hours for different activities such as fun, open swim vs lap swim

All comments are shown as they were written and submitted by the respondents, and are numbered in the order they were received.

Q10. Are there any changes to the city aquatics and swimming programs that would make you use them more often?	
142	I swim 5 times a week with masters-incredible program. Disaster if we lose Tim Sheeper. Before Tim took over, there was no swimming community. City staff scribbled a workout on the white board (when city ran it) , and went to sit in office.
143	Tim Sheeper has done a tremendous job running the Burgess pool. I remember back when the city ran the old pool and the hours of lap swim availability and swim programs has gone from unsatisfactory to outstanding under Tim's leadership.
144	The current situation is ideal for my needs.
145	Tim Sheeper and his team have developed one of the most impactful, participatory, an successful swimming programs ij the entire state. He and the team are a credit to the community.
146	The hours are currently very extended.
147	Having the city invest in the pool and keep locker rooms in better shape. Also continuing the excellent array of a supportive aquatic community of all ages and abilities as Menlo Swim & Sport does now.
148	More lap swimming hours and more lanes open at the same time
149	Less focus on competitive swimming including Masters
150	Current program is fine for me, but I would hate to see a reduction of hours for lap swimming or Masters.
151	More lanes! Bigger pools.
152	No. The programs over the past 12 years have served our family of four from 5 yr olds to 16 yr olds
153	Lower the water polo fees
154	I swim nearly every day at the pool. It will be very very sad if the Master's swimming is discontinued. There is a very large group of people from Menlo Park and surrounding who are a part of this group and desperately want it to continue. I honestly don't think there is another person who could do a better job of this than Tim Sheeper; he is fair, honest, devoted, frugal. Please, please let him continue to give hundreds of us to be led by his skilled and thoughtul lead.; I am there nearly every day. I think Tim has managed the masters program, the lap swimming, elderly program, and swimming for the children really marvelously.
155	Swimming lessons for children should be accessible and affordable ,sliding scale for all Menlo Park residents .
156	no
157	if it is free and open to the menlo park residents; more accessible. it's so hard to book classes for my kids-have not been able to get one since March. They can't swim yet.
158	adult swimming lessons, water exercises
159	more and longer flexible hours; more and flexible hours
160	Open swim I'm the mornings during summer break and other school breaks throughout the uear
161	More access to lap swimmers. Means more hours of availability...
162	I was very excited when the new pools at the Arrillaga Center were opened but then found to my dismay that there was almost no recreational swim time available and what was available was in inconvenient little 30-45 minute slots in the late evening sessions; almost all the pool time was for scheduled narrow-use activities, heavy on the sports programs. I had pretty much given it up, but then saw there was a dispute with the current, and soon to expire, program provider and saw some hope. They need to go, in my opinion, and the contract given to someone who understands what a community pool, that it is not just a pool for them to run their sports programs.
163	focus on residents!
164	less fee for open swim for residents
165	cost and expense, changing times of open swim, offer MPCSD pool access, include 8ped
166	Staff should reflect the community, otherwise it feels that we are being pushed out and not important. Inclusion is vital.
167	Longer hours, year round as weather permits.
168	No
169	Offer cheaper prices to seniors. Have a pool with higher temp for seniors + disabled that can not tolerate the cold pools. Water therapy for autistic people?
170	More group lessons for kids!
171	I'm a frequent user. It's important that the pools are heavily used by regular users. Otherwise, the expense of keeping the pools open and the costs to users will be too high.
172	lower fees for seniors/more laps(?) for seniors
173	Longer hours
174	I appreciate that folks inside and outside MP can use the pools and it's totally fair that non residents are charged more.
175	Need more bike racks.
176	More for seniors
177	Non/competitive lap swimming for teens
178	Baby pool all week in summer. Lower fee or year pass for family swim

All comments are shown as they were written and submitted by the respondents, and are numbered in the order they were received.

Q10. Are there any changes to the city aquatics and swimming programs that would make you use them more often?	
179	cleaner bathrooms
180	More children lessons with qualified teachers
181	Warmer water!
182	open swim opens at 5:00am to 6:30pm
183	If it is less crowded
184	baby swimming classes with flexible hours and fees
185	Have more times on weekends and later hours during week.
186	Accessibility to older/disabled people. Treating Belle Haven Pool equal to Burgess.
187	open more hours
188	Pool should be open year round to everyone
189	Reduced fee/free for residents w/ increased hours of operations for families.
190	Just waiting for new Belle Haven Pool
191	Bell Haven doesn't have a pool or free programs for our teens.
192	A Menlo Park resident should not be charged - ever!
193	PT in swimming
194	Price and location
195	More printed information mailed to residents
196	No not really
197	n/a
198	Current swim programs for free private lessons.
199	Reduce fees. For heavens sake, if a wealthy supported community can't afford to let its residents use these facilities for free or for \$2, what community can?
200	splash pad < lane swimming
201	I've never used the pool because open swim times were so limited - need more adult only hours
202	We would use them more often if they were available. They book very fast & not all of the time frames work for full time working parents working more than one job.
203	Free/family swim last longer on weekends during the summer.
204	SHADE, aquatic safety classes, level in between kid and swim team, low chlorine, onetta harris open AFTER business hours during weekdays/all day weekend
205	Before renovation, the lap swim in Belle Haven was \$10/visit. This is too expensive for the people in Belle Haven who have lower incomes than the rest of MP residents. It needs to be cheaper and this will help it be more inclusive. These types of policies and barriers are the systemic inequalities that have led to less Black and Brown people who know how to swim. Needs to be discounted for Belle Haven residents to help fight these systems.
206	ask me after belle haven pool opens; Good luck with all that :) water aerobics in conjunction with senior center at onetta harris? ccmp?
207	all the above activities are important and could be divided with equal fines [sic] on a schedule
208	n/a
209	If there were classes for kids learning to swim on Saturdays/Sundays or in the afternoons 4-6pm during school days.
210	easier access to kids classes; they are always waitlisted!
211	splash play section for toddlers
212	N/A
213	Que alla piscinas para terapias cerca
214	I would like to sign up for children's swimming lessons of limited duration, say one or two week's worth of classes or private lessons, not an ongoing commitment I have to cancel later.
215	My family has used the Burgess pools for years, and it was one of the big reasons we moved to Menlo Park. I do see the challenge of balancing the use of the pools for training and open swim, but we are blessed to have two pools at Burgess to balance things out. I unfortunately think we need more pools than we already have, and hopefully opening Belle Haven will help alleviate the strain. I do think that people from out of town should pay significantly more than they do for these services - consider upping non resident fees. I also wish that there was more of a "community" feel to the pool. Say food truck night, or movie night or something like that to get people to come together and connect in a friendly way, similar to the way Ladera Recreation Pool is run.
216	no tengo cambios
217	awareness of offerings
218	It would just be nice to have all info @ our fingertips! Did not even know we had a recreational area that offered these amenities!
219	Would like evening hours during the week and weekends for learning to swim for adults.
220	Have the pool (longer hours) for the residents of Menlo Park, not just for the polo teams.

All comments are shown as they were written and submitted by the respondents, and are numbered in the order they were received.

Q10. Are there any changes to the city aquatics and swimming programs that would make you use them more often?	
221	Smaller classes or affordable private classes option
222	Maybe a day only for the seniors. Some might be intimidated by youngsters
223	Pools in Menlo Park should be for Menlo Park residents only; however a resident should be entitled to bring guests.
224	We love the pool! The baby pool area is wonderful. But the biggest thing that keeps us from going to the pool is the cost. It would be great if fees were reduced for residents or for parents with young children.
225	A lower cost for pool use
226	Priority on lessons, masters club, and swim team
227	I'd love more availability of swimming lessons (esp private lessons) for kids and the confidence to schedule them with more consistency (at the moment right now it's a giant scrum whenever lessons become available and swimming is something you need to learn consistently not in fits and starts). The situation is so inconsistent we've considered joining a private club just to be able to get consistent swimming lessons for the kids even though we love the instructors at Burgess.

All comments are shown as they were written and submitted by the respondents, and are numbered in the order they were received.

Q11. Please tell us your ideas, needs, and suggestions for the city aquatics and swimming programs	
1	More pools
2	Additional times for swimming lessons and open year round
3	More exercise & swim lessons. If at all possible to also allow lap swimming
4	Accessible entry/exit, adaptive swimming, adult water exercise classes
5	My husband works at a pool so we usually just go there. But it would be really nice to go to a pool in our own neighborhood. But I just found it too expensive and figured it wasn't worth it.
6	Lower the fees for families to swim
7	Teaching scuba
8	Cheap group lessons for kids; open play time with lifeguards
9	- family membership (monthly or annual) is needed - open swim for children 7 days a week for multiple hours, year round, not just summer - baby pool open 7 days a week, year round
10	I love how Burgess has a warmer pool for lessons and a colder pool for serious lap swimmers. It allows for a more diverse range of aquatic programs.
11	So grateful for the pools!
12	More master's swim programs.
13	It is not functional to have the pool operation overseen by a Librarian. He knows nothing of the pool operation. The Parks and Rec. committee appear to care less, and both defer to the City council as being the ones that are call the shots, so they do nothing. This is not just about seniors either: many kids are not athletic but do like to splash around in the pool, with or without their parents. In times past families would come and sit on the grass and just enjoy the pool. I don't think that has happened since Sheeper took over. Sheralee's program or something similar needs to be in place for elderly or disabled people. There needs to be better supervision of the programs, perhaps by the Parks and Rec. Committee, but NOT by Sean Rineheart who could care less and responds that any overview is the responsibility of the Council. There also needs to be some kind of auditing since the whole operation is run purely it would seem for profit for Sheeper, not for community benefit
14	Need water wellness program/classes similar to what there was before covid
15	(Please see above.) I am mainly interested in the aquatics program.
16	Bring back regular aqua wellness exercise for seniors three times per week
17	- Open swim time for families on weekends - Group swim lessons - Open access to lap swimming in the Performance pool (early morning and evening) so that people who work during the day and can't afford Masters can continue to swim - Limiting rental to other organizations at least until 2023 when the new MPCC opens - Reasonable pricing so all Menlo Park residents can attend - Menlo Park should take back ownership of the pool and end the arrangement it has with its for-profit contractor that has been crowding out public access in favor of private programming.
18	Residents come first - this is a PUBLIC pool
19	I'd like to see increased access, eg, open swim time for families on the weekends, open access to lap swimming, limiting rental to private parties, holding group swim lessons rather than private
20	Longer hours. Less Masters swim. Fewer individual classes and more group classes. More "slow/beginner" lanes. Cheaper rates for city residents. Especially while other pool is closed.
21	We need affordable family membership options to attend open swim times.
22	There is a huge need for older residents of Menlo Park & surrounding areas to have year-round warm water and deep water aquatic therapy to strengthen our legs, core, gluts, and improve cardio. But classes need to be taught by experts who can best help us.. not just swimmers or exercise teachers. The need is growing as more of us in the area grow older and are living in our homes. The city needs to give us the SAME amount support that it gives children and adults (who are not seniors) AND dogs!!

All comments are shown as they were written and submitted by the respondents, and are numbered in the order they were received.

Q11. Please tell us your ideas, needs, and suggestions for the city aquatics and swimming programs

23	<p>In the name of EQUITY, please invest in the children of District 1. The city council seems to be very lax in this regard.; The current MSS contractee places profits over stewardship and does not have safety of its guards and pool client as a priority. I was a Cal OSHA Safety Inspector for nine years. Without the Belle Haven pool there seems to be no emphasis on providing the children of District 1 aquatics access. The Belle Haven pool project is already well behind schedule with no urgency to improve the timeline. Why is it that EVERY maintenance project at Burgess runs well beyond the intended deadline? The recent Burgess chemical changeover is a perfect example - a one month project took four months. The Burgess instructional pull pump is another. It was known that the pump was failing several months before it failed. I know because I informed a lead lifeguard and two MODs of it failing due to the noise it was emitting six weeks before it failed. "They wanted to see how long they could go before having to replace it." "We knew three months before the failure." Why did it take 8 weeks to replace it? "We have to go China." - NO, there were domestic suppliers at a little higher cost but not overly so. I checked. "There are supply chain problems." - YES and that is why you expedite shipping (with an added cost). "We have to get a contractor." - YES of course, really?. So WHY did a two-week project take eight weeks? What are the cost overrun impacts on City budgeting and why is there no priority to execute maintenance completely, accurately and on time. As a 41-year facilities engineer and manager at Stanford I can assert that the city maintenance of the pool is SUBSTANDARD and would never have been tolerated in my Stanford department. It is costing our residents more than it should. The restrooms have not been maintained in a healthy manner and my five complaints and those of others have been met with "We have tried but the city will not do anything about it." This is shameful. Several women have told me that they have developed foot fungus from the women's restroom. If the condition of the men's restroom is any indicator then, I believe them. It took 10 months to replace a shower head in men's restroom. On three occasions, I have removed hair piles from both men's restrooms shower drain troughs (and reported to the MOD). Health and safety inspections appear to be telegraphed so that few or no potential areas of improvement are identified. I strongly suggest that the city NOT take over the pool and that a NEW pool program provider be contracted. I strongly suggest that health, safety and maintenance inspections be taken seriously for the good of the facility and the safety of the residents.</p> <p>How many MSS rescue incidents have taken place in 2021 and 2022. How many required 911? Have any rescues resulted in hospitalization? How often have in-service lifeguard training sessions been conducted in 2022 where the guards actually practice in-water rescues? Does MSS provide post-event counseling for guards who have been involved in rescue events? Saving the life of a drowning swimmer is an impactful event for the lifeguards.</p>
24	Allow lap swim with children
25	More group classes for children
26	<p>We have a pool shortage. We need another community pool option in MP and more swim instructors at the existing pool. It's impossible to get lessons at all, and with any sort of regularity. What about a snack bar at the pool as a means of revenue and community building?</p>
27	<p>Stop prioritizing Tim Sheeper profiting off of a public resource. His programs should be eliminated or cut down. The pool should ensure disabled community members have equal access and time to use the accessible pool. The elimination of the former Aqua Wellness class was devastating to most of the 40+ members who used that program. The current program is nowhere as inclusive and popular as the previous Aqua Wellness classes run by Sheralee Beebe.</p> <p>You should partner with one of the disabled community members to ensure needs are met because the current staff are clueless.</p> <p>I don't have children but see how unfair the pricing of swim lessons are. Only wealthy community members can afford the prices Sheeper sets. And this obviously impacts the priorities of pool management when they deny patrons the use of the pool in order to make profits off their unreasonably priced lessons.</p> <p>The swim teams out of Palo Alto should not be using Menlo Park pools when space is at a commodity for Menlo Park residents.</p>
28	Please consider growing needs of aging / disabled population
29	Consider enlarging the Kiddie Pool to attract more infants and toddlers. Reinstate a real Aqua Wellness Program that meets the needs of seniors. We do not need to jump around raising our cardo rate. We need strength training, balance, posture awareness, and muscle toning.
30	The locker rooms at Burgess are in serious need of upgrade both in terms of space and quality

All comments are shown as they were written and submitted by the respondents, and are numbered in the order they were received.

Q11. Please tell us your ideas, needs, and suggestions for the city aquatics and swimming programs	
31	I wish there was more access to the performance pool to people outside of the Masters program
32	<ul style="list-style-type: none"> - Open swim time for families on weekends - Group swim lessons vs. private lessons - Open access to lap swimming in the Performance pool (early morning and evening) so that people who work during the day and can't afford Masters can continue to swim - Limiting rental to other organizations at least until 2023 when the new MPCC opens - Reasonable pricing so all Menlo Park residents can swim - Menlo Park should take back ownership of the pool and end the arrangement it has with its for-profit contractor that has been crowding out public access in favor of private programming.
33	City run programs at two pools offering a full range of activities including lessons, open swim, lap swim, exercise classes, play pool. Use for competition only after all other needs meet.
34	keep it simple. keep it focused on serving residents.
35	The focus should be on servicing the community. Too many decisions are prioritized so that Team Sheeper can charge more money. If they can squeeze in charged class or program they do The city should be more involved in the programs and fee changes. After the pool opened following the Covid shut down Team Sheeper announced there were no refunds because the rates to swim had been increased so much (this was even though they did not hesitate to lay every one off. Was the city consulted on this, if they were did they seek input from anyone else.
36	Swim teams are great, but should not be prioritized over more casual use by residents of all ages, including beginning lessons
37	My only suggestion is not to change the current aquatic program nor change the current aquatic program managers. They do an outstanding job and offer a full range of aquatic programs, it could not be done any better
38	There's more demand for swim team than availability
39	Keep up the good work! In a year where other communities don't have enough lifeguards and have had to cut back on hours and programming, the Burgess pool team is doing a fantastic job. One of the best surprises about moving to Menlo! Please don't change anything.
40	Please do not ruin the wonderful pool programs and services we now enjoy. No one group is unfairly advantaged and all are welcome. We have a year round program that is unique on the peninsula. We are so lucky. Tim Sheeper has done an amazing job running the pool in a professional manner that benefits all users. Too bad you took away the Belle Haven pool....
41	Better safety -- often too few life guards and some of them seem distracted. Performance pool should be set to a cooler temperature. Pools are over-subscribed. There should be more difference in resident/non-resident fees so residents pay less and also to discourage non-resident use.
42	Balance budget
43	See above. Mandate a pool user rep sits of recreation committee
44	Swim lessons, esp for young people (beginner level). It would be cool if there was a feeder into a competitive swimming program for kids who are interested (doesn't necessarily have to exist at the Menlo Park pools).
45	Needs to be cheaper for residents.
46	Keep it simple and accessible to Belle Haven residents
47	Group swimming lessons every day for two weeks for beginning swimmers
48	Learn to swim programs should have highest priority, since they can save lives. Next highest priority should be recreational swimming and recreational pool exercise. Lowest priority should be competitive swimming.
49	Ideally, more swimming lessons available during after school hours; expanded capacity for childrens' year-round swim team.
50	I think there should be discounted rates for people who need it for family swim and exercise classes and lap swimming.
51	Hire more people.

All comments are shown as they were written and submitted by the respondents, and are numbered in the order they were received.

Q11. Please tell us your ideas, needs, and suggestions for the city aquatics and swimming programs	
52	Group swim lessons over private ones. Competitive swimming and masters serve more people per lane than lap swim. Lap swim is important and also important lap swim lanes serve more than 1-2 people per lane to make best use of our resources.; I'm happy with how the pool has been managed. I know this has stirred controversy but we should be doing more, not less, of this. It's well run and available. I remember when it was publicly run and it wasn't as available to residents. The org running it is doing a great job and communicates well - I am on the emails so get updates on changes to schedules, etc.
53	If there are some residents who feel like the fees are too high for the pool, perhaps some funds could be allocated to help low-income residents or fundraising for nonprofits encouraged. It is difficult in a city like this to make sure all needs are met, so focus on the fact that many are happy with how they are run instead of just listening to those who simply complain the loudest.
54	N/A
55	none
56	Please encourage our existing pool operator to continue doing what they are doing.
57	nn
58	The best thing Menlo Park has done was get Tim Sheeper to provide the programming and management of Burgess and Belle Haven pools. Please do not force him out or scare him away due to the complaints of a few malcontents and town grumps.
59	None - since I don't use the program.
60	Programas de natación con costos accesibles para niños y adultos, especialmente para residentes de Menlo Park.
61	I usually avoid the pools because of the expense, crowding and most importantly because I have very sensitive skin and cannot tolerate most pool disinfectants. I used to be an avid swimmer and have neighbors who rely on the various swim programs the City provides, so I'm very much in favor of the City running swim programs for all ages and abilities.
62	It would be nice to have more options for beginner swimmers.
63	Offer more swim lessons please
64	-Programs need to be for low-income residents.
65	I'm on the Menlo Masters team, moved from Sunnyvale to Menlo Park specifically to swim on this team, that's how much this team means to me.
66	Burgess Pool is awesome. Well-run, serves a wide community, lots of hours, great activities for all ages and abilities.
67	Keep the masters swim team & youth Sports
68	I am impressed with how the Burgess pool is so well run, but I was deeply concerned when I read an article about changing management/programs. My family and I use the pool at least 5 days per week. My 7-years-old does the Bridge program, I do the lap and master swim and I am using the pool to teach my 5-year-old how to swim. Burgess is the only pool that I have seen that always has lanes reserved for free swimming, no matter what time you go, and has enough programs to attend to all ages and needs. Instead of discussing changing how Burgess is managed, shouldn't the city be discussing how and when to open the gymnasium?
69	Please keep the Menlo Park Pool to the standard it has been created to become.
70	I really hope that Tim Sheeper will be able to continue overseeing the Menlo Park pools. I appreciate all the work and thought that went into keeping the pools open and running during the pandemic. In general, he is on top of maintenance and ensures the pool keeps running. I joined the Menlo Masters swim team 9 months ago as a fairly new swimmer. Since then I have been swimming four to five times a week. I was fairly new to swimming when I joined. The swimming community whose glue is Tim Sheeper has been the thing that has gotten me through this year. It would be such a shame to see that come to an end.
71	No business owner can operate with a 1 year contract and retain employees. If Menlo Park City employees only had a 1 year contract, they would all resign and go work for another city. Please treat Menlo Swim and Sport as you would treat City employees and offer Menlo Swim and Sport a 3-5 year contract. I will not vote for these council members again if they let the pool shutdown by having unreasonable, unrealistic negotiation tactics. Other cities envy the aquatics program we have and this is one of the many great things going on in Menlo Park right now.

All comments are shown as they were written and submitted by the respondents, and are numbered in the order they were received.

Q11. Please tell us your ideas, needs, and suggestions for the city aquatics and swimming programs	
72	Please keep them as is, I heard ridiculous comms ts by the major threatening to close the pool or have the city manage them !!! my kids learned to swim here.. I lap swim there and have been a swimmer for all my life- not even in Florida we have the quality of pool program s and management we have here in Menlo Park; MP is already a Mecca for swimming - I know the council is considering changing current management but tis is really a bad idea - if you look at the data MP has more lanes open, more programas available and more access than an y other pool in most of California.
73	Too much effort on profit, not enough on resident needs. Youth competitive teams belong in high schools and country clubs. Triathlon etc. belong in the ocean.
74	priority to seniors and disabled to get into and out of the pool and classes for their needs
75	I love having lap swim available for all hours and Masters swim at convenient times. It also important to me that my teenagers are able to swim laps during regular lap swim times.
76	I would like to KNOW that the City Council and the Mayor herself have researched all other aquatics facilities owned by municipalities in San Mateo County to see how well this facility has been run since Scheeper took over. If this was done, it would be a well known fact that we are not rivaled in this county in terms of the opportunities offered.; Let Tim Scheeper and his team of professionals make these suggestions and LISTEN TO THEM. Believe me, they know.
77	More affordable swim classes for kids, it's way too expensive for an average family. More options for group classes.
78	Please keep Menlo masters
79	Please keep children's swim teams and summer camp!!
80	I believe the current aquatics programs are well run and represent the needs of a cross section of the aquatics community. One of the problems has been the closure of the Belle Haven pool for remodeling, which has impacted the utilization of the Burgess Pool. The current contractor of the aquatics program responds to the needs of the pool users. The variety of programs for the elderly, kids and teen swimming programs has been a good mix. Lack of city response to the maintenance issue in the instructional pool for over two months resulted in the elderly jassercize classes and programs to be restricted to the lower temp pool. ; I believe the current aquatics programs are well run and represent the needs of a cross section of the aquatics community. One of the problems has been the closure of the Belle Haven pool for remodeling, which has impacted the utilization of the Burgess Pool. The current contract...See More
81	Keep Burgess operational! The city needs to support a well run program.
82	Would love to see a state of the art year round swim complex that is highly subsidized for residents.
83	Have the city run the pool. This is a City recreation amenity not for outsiders. I am not sure but I think the city had a swim team at one time.
84	More senior exercise program availability in the pool
85	During the summer months, provide more space in the performance pool for open swim in the afternoons.
86	It is so costly to go to Burgess for a family swim. Menlo Park residents should get free or heavily discounted passes to swim.
87	Love the swim programs! Wish the summer swim team is year round and not as intensive as solo
88	Adult swim
89	Keep Tim Sheeper , his vision and creativity are unmatched. He has created a vibrant, friendly, welcoming community for all levels of swimmer. Emotional lifeline for many , through pandemic and beyond.
90	For those of you who were around prior to 2006, the old Menlo Park pool had limited hours and was too costly for the city to run. Tim Sheeper took over running the new pools and greatly reduced the costs to manage the pool for the city. This was done by bringing in more diverse groups to use the pool - more bodies lowers costs for all. I think it is important to note that a community pool must be shared amongst many different user groups as it is today. There is a vocal group of seniors who want to swim in their own lane and complain about all the various swim programs we are fortunate to have in the city of MP. This kind of access is not practical in a public pool setting and would reduce access to all and greatly increase the cost for the city, the pool operator and users. Let things continue as they are. They aren't broken.
91	MP is known to have the best public swimming program in the Bay Area, and I'm proud and grateful to benefit from it.

All comments are shown as they were written and submitted by the respondents, and are numbered in the order they were received.

Q11. Please tell us your ideas, needs, and suggestions for the city aquatics and swimming programs	
	<p>Tim Sheeper has done a remarkable job of accommodating all of the needs mentioned above. Our biggest problem is that the space is too small for the rapidly growing demand for aquatics.</p> <p>Before a final decision please do your homework considering the rapid growth of the popularity of swimming. There was data about these trends when the decision to build a 25 yd instead of a 50 meter pool. When presenting that trend at the time 2 council members told me they wished they had that data when they first made the pool size decision. My astonishment was that they had not done that homework before they made a decision. Please don't make the same mistake here.</p> <p>Before making a decision about Sheeper and the aquatics program please look closely at the community demand. If meets the needs of a large population. Younger people are more exposed and they take that exposure and the benefit of aquatics as they age. ; See above</p>
92	
93	Keep the Sheeper team in charge.
94	Continued maintenance of the pool and infrastructure. Some showers are leaky, wasting water. There was a significant issue with the instructional pool this spring which closed the pool for weeks. Monitoring equipment and replacing things on a schedule is important for extending the life of the pool.
95	Menlo Park's locker room facilities are run down and in very much need of a modern update. The programs themselves are amazing and my children have enjoyed all levels of participation from lessons to camps and play in the water on hot days. I have enjoyed a superb and inspiring aquatic community of all ages and abilities in Menlo Park and grateful that it's a city who have kept their community pool going while my city and others have closed only for summer use. I do hope expanding use to all is what is being considered and that Menlo Swim and Sport is lauded for their ability to build back after Covid closed the pool as well as the long term impact of pool care and facilities not being invested in leaving one pool down for two plus months. ; I also am grateful for the amazing work the lifeguards & coaches do to train and keep the community safe sound the pool. I got to see first hand a rescue happen during a swim meet and the lifeguards and coaches were amazing and responsive and saved the girl's life! I absolutely want my kids trained in lifeguarding by this team currently running Burgess.
96	Continue to offer the high quality programs offered that support adult fitness through swimming, especially for older adults.
97	Have Sheeper manage all the pools & programs.
98	Team swimming from youth to old age brings life and vibrancy to the pool. It also creates demand for all family member to learn to swim. A greater number of individuals can gain benefit from organized, team, aquatics than any other program - team swimming is the highest density program the city can offer. If the city's goal is to serve the greatest number of community members, then team swimming for all age groups should be the highest priority.
99	I honestly don't think it can be better run. If this is discontinued much like the gym that the Arrilaga's donated, it will truly be a great loss. I don't think the council realizes they have been given a gift from Tim Sheeper.
100	Tim Sheeper has been instrumental in utilizing BBAF funding to provide access to children who have little access to aquatic activities and aquatic training. Some of these participants are now working at Menlo Park and other local pools. It's wonderful to see.
101	Continue Menlo Masters swimming program
102	I think I about covered it above. I think there needs to be more open swim/mixed use time. A lot more.
103	I loved to see a year round aquatics program--open swim, lap, lessons for adults, children, seniors etc.
104	Open longer hours--7 days/wk
105	I like the pools to be run the way they are currently. I'm very satisfied. No changes please.
106	<p>Please have kids love soccer, this is such a great program to have for the community. All other neighbor cities have this program!</p> <p>Please keep the kid tennis as much as possible, this is also a great program!</p> <p>Compared to Palo Alto, Menlo Park has so few kid friendly programs(kids below 5)</p>
107	The pool is extremely important as well as swimming lessons. Please keep this open
108	None
109	shrug
110	the swimming pool should be larger
111	Open swim area needs to be larger
112	Have reasonable prices for the community of Belle Haven/Menlo Park.
113	Clear guidelines/series of classes for infants & toddlers

All comments are shown as they were written and submitted by the respondents, and are numbered in the order they were received.

Q11. Please tell us your ideas, needs, and suggestions for the city aquatics and swimming programs	
114	A gym YMCA or swimming pool
115	Teach the kids to swim!
116	more instructors for PT therapy
117	n/a
118	To have transportation to and from programs
119	Low fee (\$2.00/class, visit) for resident adult, Free lessons for resident kids.
120	heated pool
121	I think swimming & lifesaving/CPR lessons for kids, in particular, are 3. Every kid should learn how to swim. Also, I was surprised that 3rd parties were managing scheduling pools. Felt dodgy & like a sweetheart deal. Audits?
122	more adult swim hours
123	Offer more swim classes for students that have no swimming experience.
124	Free/family swim last longer on weekends during the summer.
125	children's swim classes
126	Free and discounted swim lessons and club teams, especially in Belle Haven.
127	not swimmer or sports person
128	n/a
129	n/a
130	n/a
131	Indoor or at least warm water. A clean locker room/changing area for kids/families
132	esta bien
133	N/A
134	Todo lo que pusieron esta muy bien
135	Que tengamos mas piscinas para personas que necesitan terapias especiales tanto para tercera edad como general
136	Please offer children's swimming lessons that have a fixed duration with a single teacher, such as every day for one or two weeks. I don't want an ongoing commitment. I would rather sign up for a series of 4 or 8 lessons with the same teacher and pay for it all up front. I don't want ongoing charges.
137	Please keep them as they are. They are WAY better than when the city ran the pool. Current program is tried & true & FABULOUS
138	Would love to get a summer pass to use the lap pool and exercise.
139	It would be nice to have beginner adult swimming classes in my neighborhood "Bellhaven". But evening or weekend schedules.
140	*Space times open for family time *Times available for swim lessons *Most import - keep pool accessible to the community **"@times it felt the community never had access"

All comments are shown as they were written and submitted by the respondents, and are numbered in the order they were received.

Q12. How important are the following athletic programs?

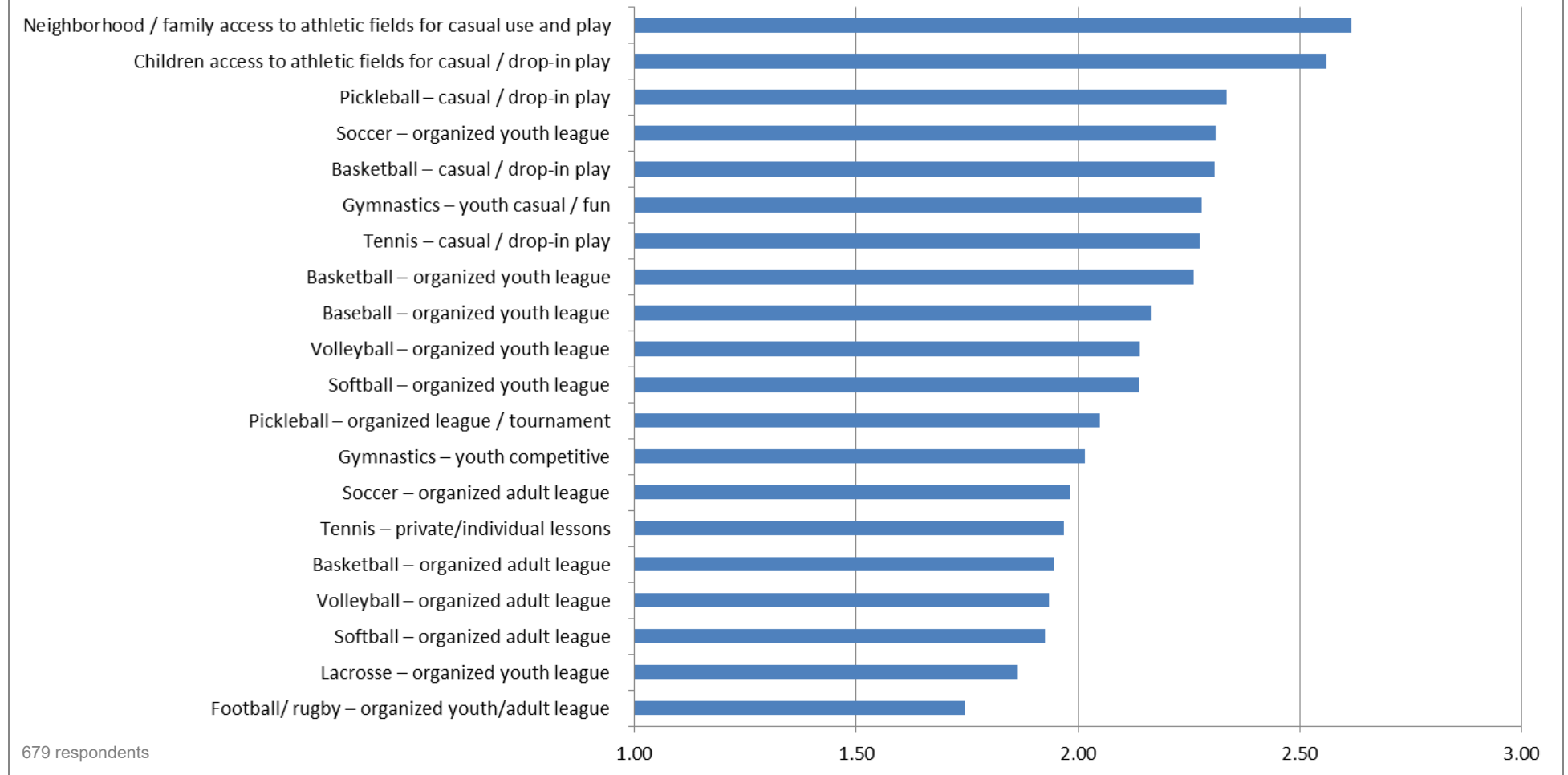

This chart shows average relative importance as rated by survey respondents. Respondents had the option to rate each item as either "not at all important," "somewhat important," or "very important." Items rated "not important" are assigned a value of 1; "somewhat important" a value of 2; and "very important" a value of 3. The chart shows the average value of all ratings for each item. Higher average ratings indicate higher relative importance to the survey respondents.

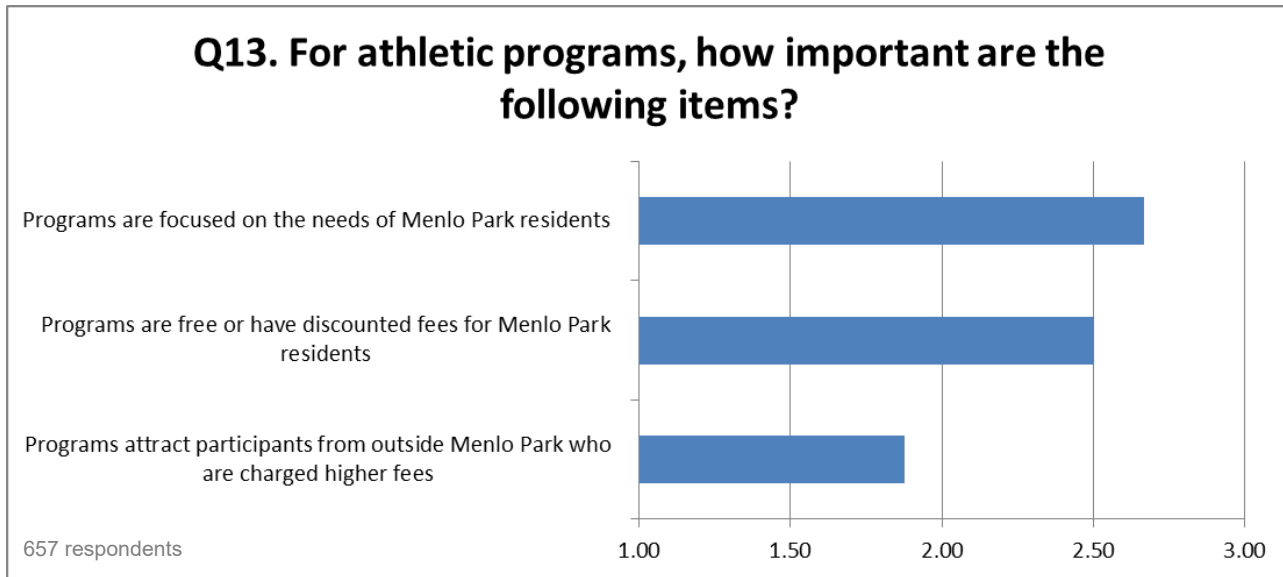

This chart shows average relative importance as rated by survey respondents. Respondents had the option to rate each item as either "not at all important," "somewhat important," or "very important." Items rated "not important" are assigned a value of 1; "somewhat important" a value of 2; and "very important" a value of 3. The chart shows the average value of all ratings for each item. Higher average ratings indicate higher relative importance to the survey respondents.

Q14. Please tell us your ideas, needs, and suggestions for the city athletic programs. [#154889]	
1	More pickleball courts, particularly at Nealon Park. In short-term, please convert two more tennis courts into 6-8 temporary pickleball courts. Longer term, please create permanent pickleball courts in Menlo Park, ideally at Nealon (and/or Burgess). Pickleball is an excellent, space-efficient, social, multi-age, multi-skill, community-building sport. It is best to have courts together in one location to facilitate community and drop-in play.
2	Re-line more tennis courts for pickleball use.
3	pickleball needs better facilities - 1) more courts at Nealon - the hub of the existing community 2) better nets 3) dedicated courts or at least courts that are painted primarily for pickleball with tennis lines for secondary use
4	I would like to see 4-6 pickleball courts in a single area in Menlo Park. This will allow pball players to just show up when they want to play and find others of the same skill area to play with. In this way, a pickleball community will be created ala what is currently happening at Mitchell Park in Palo Alto where there are 15 pickleball courts at one site. The Palo Alto Pickleball club has >700 members
5	We need more pickleball courts!! ; More pickleball courts are needed- we have to wait for courts at Nealon all the time now. Four are not enough. Thank you .
6	Again we need to build a community for pickleball. Visit the courts in Palo Alto vs Menlo and note the amount of people playing. We need more and Permian to courts in a central location.
7	Menlo Park should offer pickleball classes for all age groups. To accommodate the explosive growth of interest in pickleball we need to increase the capacity of pickleball courts in our city, both in the very near term (e.g. converting more tennis courts for both pickleball and tennis usage) and long-term (e.g. more permanent dedicated pickleball courts). Pickleball is a very social sports that promotes the sense of community and a wonderful way for our residents physical and mental well being. For the immediate term I believe converting 2 tennis courts in Nealon Park for dual use of pickleball and tennis is a low-cost and effective way to address the pickleball community's need immediately.
8	Ensure that there are sports for children age 7 and older.
9	There's a huge community of pickleball players who are not being well served at the temporary courts at Nealon. There needs to be 2 tennis courts set aside to share so 8 pickleball courts can be available -- something that is needed and demonstrated by the large number of pickleball players each day. The courts need to be grouped, not spread around the city like tennis courts. The community that has been created and continues to thrive & grow needs a central place since one can show up solo to play anytime (unlike tennis). Day after day it's clear that there are far more pickleball players than tennis players there -- it's time to come up with a better solution. Please think about the community and make sensible decisions.
10	We desperately need additional pickleball court capacity, preferably at Nealon Park which has become the defacto hub of the pickleball community.
11	Short term conversion of 2 tennis courts to 6-8 dual use pickleball courts at Nealon Park Long term more and permanent pickleball courts at Nealon Park and possibly something at Burgess.
12	More pickleball courts.
13	There should be enough variety that kids have opportunities for participating in non-organized sporting activities or on a team and some variety for adults. Access to space and opportunities to play sports on a casual basis, like going to shoot baskets or use a reasonable sized grassy area to play informal soccer.
14	My husband has really enjoyed playing softball for the recreation league and my sons have been playing Little League. Sports is 3 to our family.
15	Keep it reasonable
16	- tennis courts should not be used for pickleball or other multi-use activities. They were built and designed as tennis courts and should remain. - tennis court access should continue to require an annual key
17	2 additional mixed-use pickleball/tennis courts, dedicated pickleball courts in the future (across MP)
18	Open gymnastics classes
19	I much prefer true grass fields rather than turf.
20	Do not know much about city needs except as regards the pool.
21	Gymnastics programs for pre-competitive and fun.
22	Due to COVID, so much program opportunities were lost. It will take time to get programs up and running AND IT MUST BE A PRIORITY for the spiritual (yes, sports have a spiritual component) and cultural benefit of Menlo Park. ALSO, focus on the needs of Belle Haven to engage youth AND adults in recreational activities.; Soccer, dance, baseball, basketball, softball, gymnastics, pickle ball and flag football at appropriately sustainable levels would provide year-around opportunity for health and multi-cultural involvement of the entire Menlo Park community.
23	Let's add more pickleball
24	Please open the gym!! It's world class facility, but it's just sitting there closed. What a waste. There's no excuse when everything is open. Privatize it if you cannot find the staff.

All comments are shown as they were written and submitted by the respondents, and are numbered in the order they were received.

Q14. Please tell us your ideas, needs, and suggestions for the city athletic programs. [#154889]	
25	There are changing trends in sports engagement from when my kids played (swimming, soccer, basketball, volleyball) and I respect that but would hope to continue to support as much as there is interest in. I do believe we should support the school league needs (both my kids also coached younger teams) and inevitable community leagues require support of neighboring community teams for tournaments.
26	Equal fees all users
27	There is a huge demand for more pickleball courts at Nealon. We need more temporary courts as the four that have been designated are often full with a line while the tennis courts adjacent sit empty. It is really important to increase the number of courts at Nealon due to the social nature of the game; in other words, if you added more courts elsewhere in Menlo Park, that wouldn't necessarily help alleviate demand at Nealon as I think most players will continue to come to Nealon to be assured of having a wide range of players (and levels of players) to enjoy pickleball with.
28	Would love more pickleball courts
29	Pickleball is the fastest growing sport, encourages drop-in and family play. Menlo Park is not keeping up with the growth of this sport like some communities. We need more and dedicated Pickleball courts.
30	Convert more tennis courts for pickle ball use.
31	More pickleball courts to support the burgeoning number of Menlo Park pickleball players.
32	Pickleball is a fast growing sport and should be better supported in Menlo/Nealon Park. There have been previous meetings with residents and many suggestions for improvements.
33	Definitely need more pickleball courts throughout Menlo Park. Nelson Park could easily double from 4 to 8 courts. Perhaps even 12.
34	Focus on the needs for Menlo Park, and needs of the common resident
35	Please bring back gymnastics there is a need for it!
36	As mentioned above, I'd love to see the gymnastics classes of all kids open up again for kids. This is a huge loss for our city and residents.
37	We need more pickleball courts. The courts are extremely crowded and generally there is a wait to use the courts. Tennis courts near Nealon park are lightly used.
38	Need more Pickleball courts. It would be great to have a Pickleball only facility.
39	Need more accessible basketball courts, pickleball courts and drop in fields. Lack of open recreation fields which do not require kids to pay to be in league
40	MORE PICKLEBALL COURTS PLEASE!!!
41	Focus on Menlo Park residents.
42	Dedicate the current Nealon Park Tennis courts #3 and #4 to 8+ permanent Pickleball courts. Leave tennis court #5 as mixed Tennis/Pickleball, if courts #3 and #4 are dedicated to Pickleball, but in the meantime, dedicate court #5 to Pickleball until courts #3 and #4 can be converted.
43	We need more Pickleball courts in Menlo Park. Ideally there would be six or more dedicated courts at Burgess (Like they have at Mitchell Park). In the meantime, the city could add a lot more temporary courts at Willow Oaks Park, Burgess and Nealon. What makes Pickle Ball so special is how it brings community together and we can easily pick up a game. So the ideal situation would be a number (6, 8 or 10?) of DEDICATED Pickleball courts in the middle of the town - accessible to all, with a bathroom nearby.
44	need to have PERMANENT pickle ball courts, not just temporary ones set up on tennis courts. creates conflict between PB players and tennis players.
45	Dedicated pickleball courts and more dual pickleball/tennis courts
46	More pickleball capacity - more converted courts in Nealon Park, additional capacity in other parks
47	Physical fitness is really important, so thank you for supporting sports programs for children & adults. For me, my priority is pickleball.
48	More pickleball courts Nealon Park or Willow Road Dedicated or shared with tennis
49	Dedicated pickleball courts and develop a program within Menlo Park similar to Palo Alto and so many other citirs
50	Need more timely feedback from users. For example I have never had a survey from Menlo Park in the 7 years I have been using the pool until this survey. Why not send it to all participants at the end of every session or class throughout the recreation programs? The library has been remodeled twice during which time no major improvements or expansion has been made to the pool. Why? How did Cubberly in PA know to move to 21 pickle ball courts while Menlo Park just envelope 2 courts last year? It seems the sports programs are heavily male oriented. If one had better pool facilities then a more diverse program could be offered such as synronized swimming as an example.
51	please NO MORE PICKLE BALL COURTS
52	Convert more tennis courts to dual use pickleball courts

All comments are shown as they were written and submitted by the respondents, and are numbered in the order they were received.

Q14. Please tell us your ideas, needs, and suggestions for the city athletic programs. [#154889]	
53	More pickleball courts as this sport is growing so fast and there's not enough space to accommodate for all age groups that are playing. Please convert two more tennis courts at Nealon into dual use courts, into 8 pickleball courts to allow 32 pickleball players to use the same space that 4 tennis players use.
54	Have more pickleball courts. I have noticed that many times of the year the tennis courts are not being used. Could you please convert more tennis courts to pickleball courts?
55	I previously mentioned the need for more Pickleball Courts. Mitchell Park in Palo Alto has more than a dozen Pickleball Courts, and their popularity continues to rise.
56	I request that you create permanent Pickleball courts in Nealon Park and convert two tennis courts in the park to Pickleball courts. I play Pickleball there frequently, at different times of the day, and there are always tennis courts available, but not always Pickleball courts available.
57	Pickleball groups!
58	KEEP REVELANT TO COMMUNITES CLOSET THAT WILL USE THE CENTER AND INCLUSIVE
59	Local adult leagues (soccer, volleyball) would be great for my husband
60	More pickleball courts. Critical need. Fast growing sport and fun
61	Menlo Park School rec facilities should be made available for residents use when school hours are over. Atheltic tracks for example.
62	Make facilities available for drop-in or casual use should be highest priority. Next priority should be classes. Lowest priority should be competitive leagues
63	If local schools have league play for baseball, soccer, etc then these programs have less priority for the city to provide.
64	For older adults
65	Remember to leave time/space for casual play/use on all fields. Often people want a place to just toss a frisbee, toss a football, or do summersaults. When I walk past the park it's so nice to see everyone enjoying it, not just organized soccer teams. Give the parks back to the people.
66	2 additional courts at Nealon Park need to be converted to dual pickleball/tennis usage.
67	Convert more tennis courts into pickleball courts
68	Pickleball is a rapidly growing sport and 2 additional tennis courts in Nealon Park should be converted to dual use for tennis and pickleball.
69	I'd love to see more pickleball courts, as well as organized play for Menlo park residents. It's a great way to build community within Menlo park.
70	Two tennis courts to be converted to dedicated pickleball courts
71	tennis courts in Nealon Park should be converted to dual use for tennis and pickleball. Would be nice to have them be Pickleball only but we can start with dual. but pickleball is definitely way more popular. we are there all the time. and there are so many of us and we are there all the time
72	PLEASE bring back the gymnastic program for kids.
73	More Pickleball courts
74	I would like to see at least 2 tennis courts in Nealon Park be converted to exclusive use for pickleball. Failing that, perhaps dual use for tennis and pickleball.
75	Pickleball is exploding around the whole Bay Area. The courts at Nealon Park should be made permanent and expanded to at least 8 lit courts. Because of the drop-in social nature of pickleball it is best to concentrate the courts in 1 or 2 areas rather than distribute them like Tennis courts.
76	It would be great if two more tennis courts in Nealon Park could be converted to dual use for tennis and pickleball.
77	There are so many Pickleball players playing at Nealon Park, that very often the 4 temporary courts located in tennis court #5 are full (16 people playing) and there are people waiting to play next. At the same time, courts #3 and #4 are empty or have at most 2 people playing. I would suggest converting tennis courts #3 and #4 into 6-8 permanent Pickleball courts (no sharing with tennis) and keep the temporary Pickleball courts in tennis court #5 shared with tennis, bt with priority to Pickleball if there are more than 8 Pickleball players waiting to play in courts #3 and #4. Courts #1 and #2 would still be dedicated to tennis and court #5 could also be used for tennis if courts #1 and #2 are full.
78	Over the years my kids have used participated in organized soccer, basketball and tennis programs and we have been very pleased with them
79	If the city's parks and recreation department can focus on opening up facilities rather than keeping facilities locked, then maybe we can start moving forward toward providing the tax payer a place to recreate. Allow local entities (clubs) to run your tennis and pickle ball, soccer, volleyball, and basketball leagues and socials instead of locking the courts.
80	Re-opening the gymnastics center and adding open practice time hours
81	need pickleball classes & more courts; n/a
82	Love to see More pickleball courts added or dual Tennis courts made available

All comments are shown as they were written and submitted by the respondents, and are numbered in the order they were received.

Q14. Please tell us your ideas, needs, and suggestions for the city athletic programs. [#154889]	
83	Again, offering pickleball classes for residents is a great way to introduce people to the game.
84	Pickleball courts!!! There is a current high demand and a super fast growing population. Kids through older adults. Amazing community experience. It MUST remain free for use!
85	More pickle ball courts are needed. They are full every time I go to play and the sport is gaining in popularity.
86	No suggestions other than survey responses.
87	Menlo Park's adult sport leagues are a whole lot of fun. I loved playing adult volleyball years ago, I don't recall us ever competing, but we did get coaching to improve our game. It was casual enough to include anyone willing to try, but serious enough that the games were well played. I hope the City continues providing sports opportunities that allow anyone to try out.
88	Expand pickleball program
89	Please continue to invest in the Belle Haven community.
90	Juggling time
91	I would like see more Pickleball permanent courts by Flood Park.
92	Pickleball
93	Stability, predictability with respect to facilities operations. I am willing to pay to participate.
94	It would be great if the gymnastics facility is reopened soon and is run as well as the Burgess pool.
95	continue to have professionals manage them
96	They should be based on fun, health & safety. Youth competitive programs belong in schools where there are more facilities and which are better funded. Semi professional athletes should NOT take up community facilities, especially to the exclusion of other members of the community. Too much emphasis at least with respect to the pool is placed on profit. Perhaps this is so with gymnastics and tennis and this is intimidating for ordinary people
97	We would like the gymnastics program to return. It was a place that we could always meet many of the kids at Menlo Park. It would also be nice if in addition to gymnastics there was another strong program or 2 I which residents are likely to meet their neighbors. Also would be nice to have more adult classes at various hours of the day (including everythings for working parents)
98	Hire professionals to make these decisions and let the residents deal with those decisions. Stop listening to the squeaky wheels and gather information on existing programs that are successful!
99	I'd love to see athletic competitions that splits the sexes. My daughter adores basketball but gets ignored in a coed team because it's usually all boys and this is so disappointing to her. Boys and girls play sports very differently and in the elementary ages separating them helps the experience a lot. My son who is 5 would prefer not to play with girls because his exuberance sometimes scares them.
100	I think they need to be restored to pre covid levels and service. City management has been derlict in the negligence of the recreation center and the restoration of programs.
101	I do not utilize these programs.
102	reservations for some tennis courts so that they're accessible for everyone and not just children/students
103	I put only organized sports as 2 because I feel these should be City leagues. With Menlo Park as the organizer. It is ok to have sponsors but the leagues are part of the city. Not AYSO, etc.
104	pickle ball lessons
105	Multiple questions have dealt with non-MP residents. I think non-MP residents should be charged a higher fee. But is the goal to purposefully entice them to come? To pay the higher fee? If the question is "Should non-MP residents be charged more?" then "yes".
106	I no longer have children that would use the athletic programs therefore suggest more senior programs if available
107	Please reopen the dog park on the baseball field!
108	Please include badminton
109	We need a permanent dog park in Menlo Park and the west side of El Camino.
110	Pickleball added every opportunity. It's an incredibly accessible and fun sport. Let's get courts included in the Flood Park renovation. Nelson park was a great start but mainly benefits just West Menlo in closer proximity.
111	Please bring back gymnastics. Please expand more pickleball courts.
112	None; Allow dogs off leash on fields during certain hours in the evening
113	While the sports resources should prioritize Menlo Residents, people from the surrounding community create enough demand to support programs like Swim teams, Masters and Sr. AquaFit. The pool brings people to Menlo Park and people in turn spend time in Menlo park shopping and eating out. I do more business in Menlo as a result of swimming several times a week
114	I would like to see the gym open again and Boot Camp reinstated.
115	Be grateful for the management you currently have!! It will never be better and a total loss if discontinued.
116	Softball for adults, gymnastics for kids

All comments are shown as they were written and submitted by the respondents, and are numbered in the order they were received.

Q14. Please tell us your ideas, needs, and suggestions for the city athletic programs. [#154889]	
117	The pickleball courts at Nealon are increasingly crowded. More pickleball courts would be appreciated.
118	PLEASE PLEASE We would LOVE to see the Arriaga Gymnastics class for toddlers/childrens come back.
119	Adult gymnastics is important for our household!
120	focus on residents!
121	It is so important that their is inclusion for all races and ages.
122	Pilates?
123	More pickleball courts
124	students sponsored for lead athletic capabilities
125	Keep up all sports, it is so important for health as well as social well being
126	More Pickelball courts
127	We need pickleball courts as the Palo Alto pickleball courts pre over crowded; We need pickleball courts as the Palo Alto courts are over crowded
128	Pickleball is getting so popular in the bay area. Need more courts in different cities that are open 7 days a week to lessen the burden at existing pickleball courts.
129	Significantly more dedicated pickleball courts needed!
130	More pickleball courts. Fast growing sport. Lots of fun.
131	More pickelball courts. Good for all ages. Please come and join. Good for your health
132	Pickeball league. And ladder. Pickleball pot luck. And fun days
133	I play pickleball three times a week and I enjoy the social, exercise and competition with others. It's a great sport and we need more pickleball courts in areas like Menlo Park and surroundings areas as well since the sport is the fastest growing sport in the U.S.
134	Additional multi court facility for pickleball, or fully expanding dedicated pickleball courts at Mitchell Park would go a long way in relieving stress on an already maxed out community gem!
135	More pickleball courts please. The tennis courts stand empty so many hours per day
136	pickleball is very popular now, please have more courts, so residents can join any level games
137	More Senior programs
138	?
139	I have played in the past at Kelly Park Pickleball Courts, and now play a couple of times a month with Menlo Park residents at Nealon. Nice courts and facilities at Nealon, but at times they are overly crowded. It would be nice to have a few extra courts to allow for all who want to play and also those who want to drill.
140	More robust pickleball offerings benefit not just Menlo Park residents, but the surrounding areas.
141	We need more pickleball courts
142	I think larger fields would be better
143	Playground at Sharon Park needs to be bigger.
144	Basketball classes for kids
145	Would be helpful to have a magazine every month or app to show what activities are playing and the cost, time, date.
146	Belle Haven needs recreational programs focused on the needs of Belle Haven residents, not of outsiders who rent the only facilities we can get to and keep us from using them
147	Basketball gym in belle haven
148	-more easy access to facilities -more water bottle fountains
149	Supervision at All times maybe 2 1/2 hrs. If At All Possible
150	No fees should be charged for Atherton residents
151	We should provide priority of the user to Bellhaven residence
152	more advertisement of adult leagues
153	I hope priority will be given to athletic programs that are from eastern MP first. West MP has nice facilities already.
154	kid's soccer
155	over 40 & over 50 sports leagues. how about clinics to train officials
156	n/a
157	n/a
158	n/a
159	Having noncompetitive programs that focus on kids learning to play different sports and team culture. Having these youth programs be available for starting on weekdays no earlier than 3:45pm and to be completed by 7pm the latest. Having multiple weekend options. Having rec sports for kids <10 years old
160	muy inportante
161	N/A
162	Esta muy bien todo me gusta mucho
163	I like the girl's volleyball program in particular. Please continue that.

All comments are shown as they were written and submitted by the respondents, and are numbered in the order they were received.

Q14. Please tell us your ideas, needs, and suggestions for the city athletic programs. [#154889]	
164	Have Menlo Park have their own baseball, soccer, etc, competitive teams.
165	Look. People in the community need programs for community. There's plenty of community that will benefit from a lot of programs like the Midwest. We need more for our community

All comments are shown as they were written and submitted by the respondents, and are numbered in the order they were received.

Q15. For city library and information resources, how important are the following items?

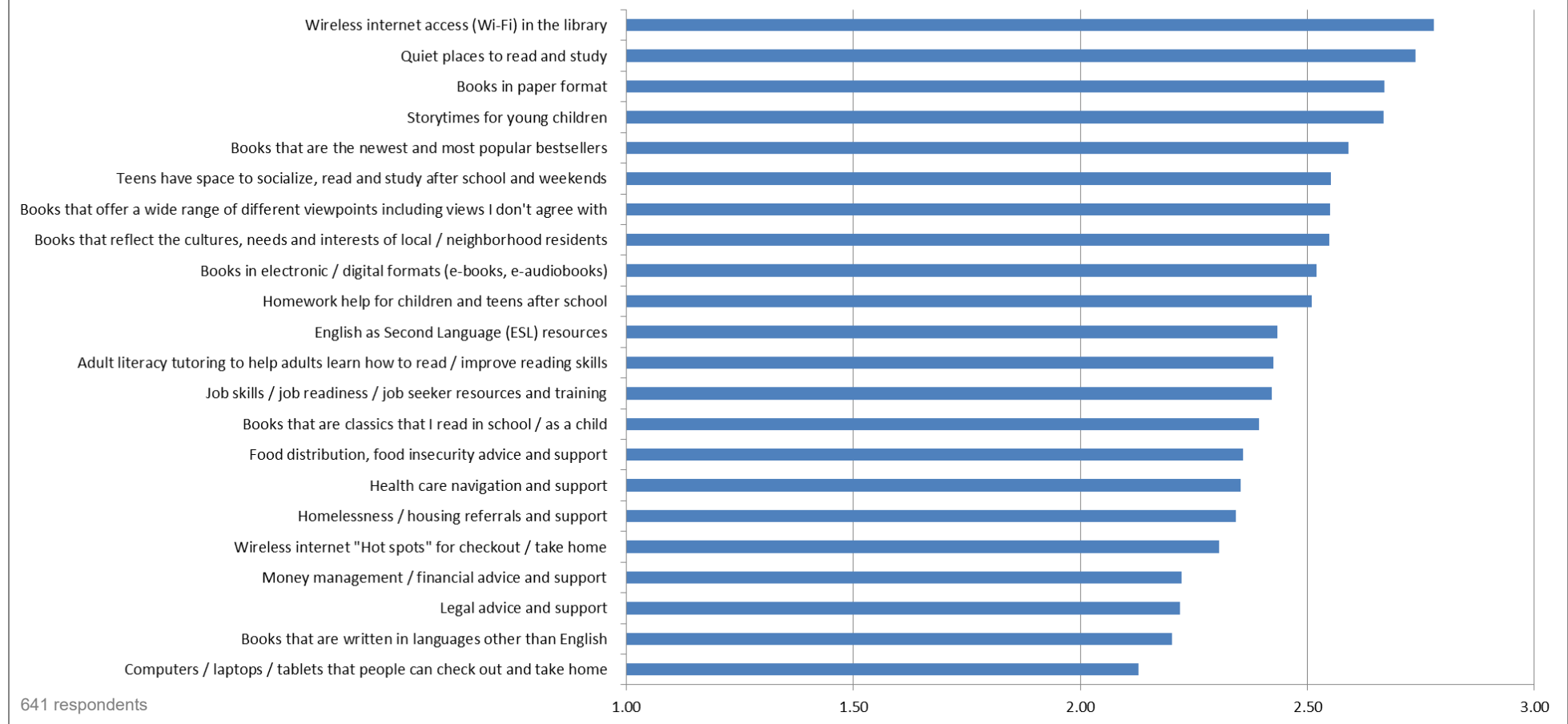

This chart shows average relative importance as rated by survey respondents. Respondents had the option to rate each item as either "not at all important," "somewhat important," or "very important." Items rated "not important" are assigned a value of 1; "somewhat important" a value of 2; and "very important" a value of 3. The chart shows the average value of all ratings for each item. Higher average ratings indicate higher relative importance to the survey respondents.

Q16. Please tell us your ideas, needs, and suggestions for the city library and information resources	
1	If wifi isn't already available throughout all areas of burgess park, in my opinion it should be. I'd like to see an increased focus on providing access to digital assets. It is important to have a few devices (computers/tablets) available for checkout to residents for free but it would be interesting to do the math on the feasibility of a rental program. I would also love to see Stanford and Facebook (in particular but not exclusively) be required to provide access to libraries, computing resources and instruction as part of their development requirements.
2	These questions are confusing. Some of these services are important for residents like job readiness or food distribution but these are already provided by other community services organizations. Letting 3rd party providers use the library as a location to provide these services makes sense but the city does not need to hire staff to provide them. That would be duplicating other organizations that already have these resources.
3	I homeschool my family and we go to libraries. But the Belle Haven library is where we've been going previously. Mostly. But I don't feel like it's a city library. It is a school library. Make sure that the new library is welcoming for all and open regularly. I really like the city of Palo Alto library at Mitchell park. It has a nice kid section and is up-to-date with tech.
4	Homework support
5	- the library should not be the location of social services (while 3 including services for learning to read/write, ESL, food, homelessness). These should be provided elsewhere. The library should be what it is intended for; a place for books, reading, and children. Children's learning to read, access to books, safety, and exposure to positive individuals and role models at the library should be prioritized.
6	Not sure what the resources are that can address all of these issues. They all seem important. Certainly furnishing books, homework help, adult literacy, ESL, preschool book time are all important,. One would have to know a lot about other agencies meeting these needs to answer this question.
7	outdoor benches, spaces to gather outdoors near library. also community meeting rooms available. appreciate being able to donate books knowing it will benefit community/library services!
8	More resources for infant/toddlers- ie better facilities, better books, more interaction, etc
9	I feel that many of the services suggested under library are 3, however am not sure the library is the best venue for providing access.
10	We love the library and appreciate all it does. E-books, books, and quiet space are particularly important!; We love the library and everything it does. Don't change a thing — they're doing great work!
11	Larger library budget for hardback books, e-books, and purchase of CDs or streaming services
12	Leverage our resources to help support the growth & well being of our residents
13	I am answering that these activities are not important to me personally. I am 81 and childless.
14	Make the library a place that has many shelves of books again, widening the range of books for people of all ages to browse, use them for reference, etc. - a public commitment and encouragement for people to read and learn to read. This should include books on all the help topics listed above, as well as reference librarians who can help people find and use these books.
15	Food distribution, Health Care & Homelessness issues-housing referrals & support- These are all areas I was not aware were handled in our Library. I would think they would be handled in the City Hall. They are issues for sure- even here in Menlo Park, but I think they should be handled where there is more privacy for the individuals- they deserve respect just as much as any other person.
16	Please reinstate Project Read. Thank you for reinstating Conversation Club.
17	I have found it difficult to reserve e-books given long wait times. Given the popularity of kindle and similar devices, it would be great to put an emphasis on expanding access to borrowed e-books.
18	More after school youth programs, tutoring and study skills
19	Increase the offers of audio books (especially new ones)
20	More complete collections of current fiction. Less "let's promote these 20 titles" to virtue signal just how woke we are. Get over yourselves, you're a library, you shouldn't be carrying an agenda.
21	I used them constantly with my children when they were growing up. They are vital!!!
22	Rodent abatement & awareness
23	The ideological bent of the books is very far left. This does not respect the diversity of our area. Also, there are practically no non-fiction popular ebooks related to business or technology. I have tried dozens of titles and they are literally never there. This is Silicon Valley! When an Apple engineer writes a book about Apple, it should be available in our library!
24	Make Bellehave Library bigger
25	Focus on the needs of the communities closest to the center.
26	Would love more regular in-person teens events
27	Increase hours the library is open.
28	Food distribution, housing referrals, job skills, legal advice, money mgt are issues addressed by many other organizations. I do not see these as additional services to be provided by library.
29	I love our library and think adult literacy programs are 3.

All comments are shown as they were written and submitted by the respondents, and are numbered in the order they were received.

Q16. Please tell us your ideas, needs, and suggestions for the city library and information resources	
30	I used to visit the library frequently but stopped after sitting next to people who were there only to sleep. They snored really loudly and didn't bathe often. I also grew tired of asking people to keep their voices down. People often go to the library for a quiet place to read. It seems that a quiet library is a thing of the past, which is too bad. If I check out a book I take it home to read.
31	I didn't realize the library had all these amazing services. Are people taking advantage of them? Do they need to be promoted more? Regarding books in different languages, Spanish is a priority but other languages less so in print. Maybe those can be available electronically.
32	Offer more audio books and e-books, especially for newly released books.
33	Keep up the good work!
34	requesting books be transferred from other libraries takes a long time
35	Are there print for fee printers?
36	I love the library. I go there at least twice a week. I really appreciate the access to Link+ which brings books outside the system to me. I like being able to put movies "on hold." I have more than once suggested a book or film and had the request answered. I am worried that the librarians are being tasked with being social workers. I noticed an adolescent boy who seems to not be able to leave them alone and constantly touches things on their desks and asks them questions. I think the public restrooms in the library are important. I love the tiny space with books for sale. I think the "seed library" is a very original idea. The on-line programs hosted by John Weaver are a bonus.
37	We'd love to see higher quality Spanish children's picture books and early chapter books available. So many children participate in Menlo Park Spanish Immersion classrooms (about 40% of all children at Encinal and Laurel) and we need to offer better options for them to practice their reading skills, learn new vocab, and enjoy books in the language they are learning. Not just translations, rather books from native Spanish Speakers are ideal.
38	Community Meetings to talk with City Commissions / City Staff
39	-Programs that promote inclusion and diversity -Programs that address and dismantle institutionalized racist practices
40	#15 is hard to answer- it obviously depends on which branch and the communities being served. The librarians will likely have informed suggestions about what needs to be provided.
41	Agree with need for food/homeless/etc. support. Disagree that library is the place to provide those services. I stopped going to MP Library years ago due to a pattern of creepy approaches & unwanted attention from homeless men lurking near entrance. And stagnant air inside.
42	The breadth of services listed in this questionnaire is exciting and would make me inclined to spend more time at the library.
43	it would be great to have a space where visitors are allowed to talk away from the quiet areas.
44	i think WiFi and ebooks are a must - why are we questioning this?
45	In person story time for young kids on the weekends either in the morning (10a) or afternoons (4:30p) to avoid overlap with naptime
46	I would consider our family library super users, visiting 4-5 times a week with about 40 books out regularly and we sometimes attend events as well. As an involved person, I once applied to the library commission and was not accepted. Okay, but the person who was reached out to me at some point later to try and engage me through a typewritten letter to share she had gotten the spot and could we meet for a cup of coffee to chat midday. That experience was so strange to me since it felt like an old fashioned process and really turned me off from civic engagement and I haven't applied again. It worried me that the libraries didn't have a modern thought approach to services and didn't respect that some people who want to get involved have demanding day jobs and childcare to cope with, too.
47	More community events in the library
48	I hugely appreciate the activities and events for kids, especially in the summer. I rarely have time to go to adult events, given family and work obligations, but I love the fact that they are there and look forward to spending more time at events when the kids are older.
49	We are often looking for new children's books and series and they aren't available at MP. Would love to see more for growing chapter book readers.
50	It would be nice to have an enclosed patio of some sort close to the library with seating where people with pets or thing children could sit and read without fear of their kids or pets running into the street.
51	Can we do a childrens used book fair organized by book type?
52	The library was very slow to reopen to full time service to the community. Again, due to lack of city management oversight of services paid for by taxpayers.
53	So many San Mateo counties have been renovated or rebuilt for a modern era. Would be wonderful for Menlo Park to do the same. The Atherton and San Mateo libraries are just gorgeous and offer all kinds of opportunities for all ages.

All comments are shown as they were written and submitted by the respondents, and are numbered in the order they were received.

Q16. Please tell us your ideas, needs, and suggestions for the city library and information resources	
54	I never go in the library. I used to when my kids were needing to go in. There was a librarian I did not like so it was easier to stay away. With Covid I definitely will not be goin in.
55	The library cannot be all things to all people - for example, providing healthcare and legal support. These are important needs but beyond the scope of what the library should focus on. The library should focus on literacy, information access, and referrals to other agencies to handle homelessness, job skills, etc.
56	I noticed we no longer can print materials at the library and do think we need that capacity available when using checked out laptop to print material and copy machine is no longer at library and we should have that for convenience purposes.
57	Please increase the number of ebooks you make available to check out. All new books should come in both paper format and electronic format to check out.
58	More availability of ebooks
59	The library has excellent resources, the speaker series is especially strong
60	Continuing services as is.
61	Earlier opening times in the mornings would be helpful.
62	The social services could be housed in the rec. center or part of city hall
63	outdoor kids storytime
64	The library needs to be open earlier in the morning every morning. It needs more Spanish board books for the baby's and toddlers. The Spanish picture books and leveled reader selection needs to be expanded, more centrally located in the children's section, and displayed in a way that's easy for elementary school kids can access. Two of our elementary schools have 2 classes of Spanish Immersion for almost every grade, and the library should reflect that.
65	large book collection, audio selection. Nothing worse than a poorly stocked city library--
66	Library staff should reflect the people who live in the neighborhood. It feels more acceptable and welcoming
67	Keep real books available. Have authors come visit
68	Please congratulate the head librarian on all the wonderful changes-lots of creativity.
69	It would be great to offload older books to a warehouse to be ordered and extra space could be used for conferemce rooms and maker / craft / DIY spaces
70	love the library book selection, love the bookstore
71	Community is getting older, more day-time programs for seniors will be great
72	Please keep the library open and full of librarians. we need this service
73	Toddler Storytime. More displays by topic in the children's area to help kids find books.
74	?
75	more books would be better
76	There should be more mythology books
77	Maybe more graphic novels? Honestly everything is pretty good here
78	Extend the hours of Belle Haven Library.
79	Children reading programs
80	Maybe some type of activities for kids such as reading time
81	The Belle Haven Library should be open as many hours and offer the same resources as the Main Library.
82	Outside story time for kids in various parks. Pop-up library desks on sidewalks/hosted by neighbors
83	I'd like to have a place to study and read
84	Events for teens at the library just like on the west library
85	-more story-time for the kids! w/people who are animated as they read
86	If the city is working all of the resources on the previous page, Bravo to Menlo Park.
87	Belle Haven community needs a stand alone library and police station like at Burgess Park
88	No Idea
89	n/a; Love the libraries
90	I love the overdrive app for digital books!
91	Love the libraries
92	Bravo for maintaining library services during the pandemic! I appreciated the walkup window
93	Generally think libraries can be a valuable social/community resource and inclined to support & invest
94	I have never noticed legal/food/etc. services at the library
95	Open the library to the public all day
96	Offer volunteer hours for middle school & HS students for community service hours
97	An 'open 24/7' Library
98	Libraries are critical sources of public information and should provide not only the sources but access through literacy and language programs and up to date media. They should not take on the responsibilities of other public agencies/NGOs, such as food distribution, homing, legal and financial advice and outlets for socializing.
99	we would like to see the belle haven community more equitably represented with library services and access to the community pool. the belle haven library is appalling.
100	the library is great more kid's books in spanish & hindi

All comments are shown as they were written and submitted by the respondents, and are numbered in the order they were received.

Q16. Please tell us your ideas, needs, and suggestions for the city library and information resources	
101	I would love for the city library to continue and expand community conversations around tough topics as well as those of local interest.
102	all of the above are wonderful but can only be supplied on occasion. a good referral section could advise people as to where to go to get the help they need or outside speakers. It's not a soup kitchen or hospital
103	n/a
104	n/a
105	n/a
106	maybe have more hardcover book + paperback books for sale
107	youth classes to learn how to used digital printing, learn coding/scratch
108	todo bien
109	horarios extendidos para el verano
110	updated kid/children section/outdoor/patio to read relax. Coffee stand
111	Manterner libros de americalatinos
112	N/A
113	Lectura de algun libro para saber del tema del libro y como escribe el autor y saber interes que cauaz
114	Pues si pueden aser mas esta bien muy bueno
115	Please host more events for teens, especially art or craft themed events. And please make sure event times don't overlap with MPCSD school times and events.
116	More foreign language resources for youth/teens - graphic novels etc. in foreign languages (Chinese, French, German, Spanish)
117	I LOVE this library. Not sure who said it but "all you need is a library & a garden to be happy!"
118	Have the library open longer & on weekends.
119	cursos de computacion para saber usarlos en el hogar, trabajo
120	It's good the library is open 7 days/week if possible.
121	A book club or some organized gathering would be great. Also, have author night guest and/or staff hosted lead discussions.
122	I love the library! I selected "3" for every item which may not be helpful but everything the library does is important. The library should get all the resources it needs to do all of this and more.
123	The library is one of my favorite city resources!
124	This would be amazing to support community in a Midwest way with community centers

All comments are shown as they were written and submitted by the respondents, and are numbered in the order they were received.

Q17. Please tell us any other ideas, needs, complaints or suggestions you'd like to share with us.	
1	More open access pickleball courts.
2	The city should have a greater/tighter focus on Menlo Park residents quality of life. I do not feel that Menlo Park residents have benefited enough from the growth that many of us feel has been forced upon us.
3	Allow skateboarding in town streets.
4	There is a lack of transparency in the city's prioritization between tennis and pickleball courts. It seems the decision making has rested with one city staff without any accountability. Please open up the process and stop this one individual from imposing his personal bias for the whole community. Please have this individual take direction from the City Council and the Park and Recreation. Community.
5	Menlo Park should offer pickleball classes for all age groups. To accommodate the explosive growth of interest in pickleball we need to increase the capacity of pickleball courts in our city, both in the very near term (e.g. converting more tennis courts for both pickleball and tennis usage) and long-term (e.g. more permanent dedicated pickleball courts). Pickleball is a very social sports that promotes the sense of community and a wonderful way for our residents physical and mental well being. For the immediate term I believe converting 2 tennis courts in Nealon Park for dual use of pickleball and tennis is a low-cost and effective way to address the pickleball community's need immediately.
6	We desperately need additional pickleball court capacity, preferably at Nealon Park which has become the defacto hub of the pickleball community.; Please consider converting more tennis courts to dual use pickleball/tennis usage near term (this year) and adding additional permanent dedicated pickleball courts during the next capital planning cycle.
7	Coffee shop, local arts crafts for sale, farmers market in parking lot
8	I wanna make sure that our new building and programs are top-notch. Just because we live in the Belle Haven neighborhood does not mean that we should have lower quality things. I have always felt we are treated differently than the other side of 1 oh one. It shouldn't be that way. We are all Menlo Park and we should all have equal access. On top of that, take into account why many people live in Belle Haven and that's because, before at least, it used to be affordable. I want to stay in this neighborhood and be able to afford things. Our family is not well off like many other families who live right here in the peninsula. But we care very much about it and appreciate any and all improvements.
9	The library is good and the little Friends' store at the front door is wonderful
10	the loss of multiple weekly aquafit/aquawellness exercise classes has been devastating for my health and my ability to volunteer in the community. please find a new operator for the pool services who will improve/be committed to serving ALL ages of our community and not just high performance swimmers or master swimmers or kids lessons.
11	Can we get a magic bridge playground in menlo park? Traffic on middle ave is getting worse due to nealon park and new el camino construction. It is also especially dangerous to get in/out driveways when cars parked on side of road Santa cruz ave has become a big disappointment with dated stores, empty stores, and even dated look/feel. How do we gentrify it and make it on par with neighboring down towns? I absolutely love what Springline is doing wrt bringing in quality restaurants. How do we extend this to downtown?
12	I'd love more drop in time for basketball hoops for my daughter. Appreciate rec center can be rented for events. Haven't taken classes at the rec center since our kids were little. Really hope you'll return the pool to the families of Menlo Park as it was when we first moved here.
13	Make libraries places where people can find books to read and to come together for reading-related events, not community centers which can be addressed in other city venues.
14	Please increase the number of pickleball courts at Nealon. The demand will only increase. See rates across anywhere in the nation for this evidence. Menlo Park needs to be ready for this increase in demand and it is currently not meeting the existing demands at Nealon.
15	There are far more people playing pickle ball at Neelon Park than there are tennis players. Permanently converting 1 or 2 tennis courts to pickle ball would better serve the community
16	Please make the pickleball courts at Nealon Tennis court 5 permanent for pickleball. Please draw pickleball court lines for tennis courts 3 & 4 so it can be a multi-use facility. Purchase new rollable pickleball nets for those two courts. Thanks.
17	I have found it difficult to reserve e-books given long wait times. Given the popularity of kindle and similar devices, it would be great to put an emphasis on expanding access to borrowed e-books.
18	Also the playground at nealon is not holding up well and large chunks are taken up by equipment that isn't able to be used
19	I prefer the library to remain primarily as a quiet space for books and book users. All the ancillary services being considered should maybe be downstairs so library patrons aren't crowded out by a lot of others services that have nothing to do with reading and studying. Why does the library have to provide services that are available elsewhere- like at food banks and etc.
20	Dedicated Pickleball courts.

All comments are shown as they were written and submitted by the respondents, and are numbered in the order they were received.

Q17. Please tell us any other ideas, needs, complaints or suggestions you'd like to share with us.	
21	Pickleball adoption is increasing at an exponential rate, while tennis court usage is extremely low. We urgently need permanent Pickleball courts at Nealon Park. We should permanently convert tennis courts #3 and #4 to 8 Pickleball courts (for exclusive Pickleball usage). We should also give priority to Tennis on court #5 if courts #1 and #2 are in use, otherwise court#5 can be used for Pickleball (keep the 4 temporary Pickleball courts in court #5 as well). This would give us 8 permanent Pickleball courts and 4 temporary ones (shared with tennis). Based on current Pickleball adoption and low tennis adoption, this would be a win-win for the community.
22	Convert tennis courts to pickleball courts since the demand for pickleball far exceeds that of tennis
23	request the permanent conversion of courts #3 and #4 to pickleball (keep court #5 for dual usage)
24	Please increase Pickleball access - first with temporary courts at Willow Oaks, Nealon, Burgess, then in a centralized place like Burgess with permanent courts.
25	Thank you for all your hard work to provide community services for Menlo Park residents. I have lived here for 27 years and have used the parks, libraries, pools, and pickleball courts the most. Currently pickleball is my priority. Thank you!
26	Rodent abatement, management. Owl box program. Fees to developers disturbing rat nests, rodent sanitation considerations in new development garbage areas More pickleball courts, dedicated or dual with tennis Nealon Park or Willow Road Thanks!
27	The city could do a better job of publicity when new rec sessions are starting since you no longer send out catalogues. Why not send link to those of us signed up for swimming registered users? Was recreation surgery sent to every Menlo Park household? Has a phone survey ever been done for recreation programs?
28	Convert Nealon Park courts #3 and #4 to permanent pickleball courts. In addition keep #5 dual purpose.
29	More access to pool for lap swimming, aquacise classes in the evening/night and mire pickleball courts
30	Please add more pickleball courts to accommodate for the community's needs. Short term: convert two more tennis courts into dual use courts. Long term: dedicated courts. Thank you!
31	I want to play pickleball with my friends after school. Please add more pickleball courts at Nealon.
32	Please create permanent Pickleball courts in Nealon Park and add some courts -- four temporary courts are not enough!
33	My family is just getting into pickleball and we'd like to see more courts. The tennis courts at Nealon are empty while crowds wait for pickleball courts.
34	Name rooms after community folks and make it culturally relevant to local residents, hire local residents and be aware what locals want. Reach out to local Boys and Girls/ YMCA and collobarate .
35	Children's storytimes have historically been quite crowded. Can there be more of them?
36	Permanent conversion of courts #3 and #4 to pickleball courts. Keep court #5 for dual usage.
37	More pickleball courts please
38	Increase the number of printed magazines.
39	I'd like to see dual tennis/ pickleball on more courts at Nealon park.
40	I'm surprised there was no mention of the duck pond at Burgess Park. I love walking past the duck pond but am saddened by the people who abuse it. The vegetation has been trampled, making it more difficult for the ducks to forage for food. I often see children abuse the ducks by chasing them and throwing rocks/stones at them. Many of the ducks seem to be a hybrid species that can't fly. When children are running after them they can't fly away. It must be very distressing. I also see people treat the duck pond like their private pool, bringing lounge chairs that they sit in all day. They've worn out the grass near the pond. Please take more care of the pond and ducks who depend on it. Signage encouraging respect for the wildlife would help. Also a person from the city patrolling, keeping people in line. Also signs that tell visitors to stay on designated paths and not trample on the vegetation. Please take better care of the ducks and the pond.
41	Convert more tennis courts into pickleball courts
42	Please add more pickleball court capacity. Courts can be dual use in the short term, but with growing demand dedicated courts in the longer term.
43	Dedicated pickleball courts!

All comments are shown as they were written and submitted by the respondents, and are numbered in the order they were received.

Q17. Please tell us any other ideas, needs, complaints or suggestions you'd like to share with us.	
44	<p>Pickleball is overrun with people. We need more space. We seem to have one person in management who is against pickleball. Sean has all the power and he's against it. It's frustrating since all evidence points to a future of pickleball. He makes unilateral decisions. Ugh. His reputation precedes him. Would be nice to have someone else in charge of this program. We have been waiting for over two years. He has cost the city a lot of money, making decisions that are not moving things forward. Kelly Park was all Sean and it was an unmitigated disaster. Well except for the people who go out there an teach. They know they can go out there because no one else goes out there.</p> <p>We were on course to make a decision to talk about putting lines down on the middle two courts so we would have 8 pickleball courts and Sean single handedly tabled it, saying we need to see what happens in the Willows Project -- which would be another two or so years.</p> <p>It would cost less to line 8 courts at Nealon than Sean paid to line the courts at Kelly. He doesn't know who to call. He needs to let people who know be in charge. He wastes so much money. He overpaid by over 2 times for the lines he okay'd for Kelly. And he chose black lines. Such a waste. Heart might be in the right place, but unfortunately he is the wrong person to be in charge. The parks and rec commissioners seem to all be on board and ready to go and then he pulls the rug from underneath them and us.</p>
45	More Pockle ball courts
46	I would like to see more pickleball court capacity: dual use on existing tennis courts near term, and dedicated courts longer term. Pickleball is the fastest growing sport in the US. Please add more capacity ASAP, so Menlo Park will not fall behind in planning to accommodate the growing number of players.
47	Additional pickleball courts would be great, even if it's dual use on existing tennis courts until dedicated pickleball courts are built.
48	Pickleball has become wildly popular and provides a much better usage of public space than tennis. Very often all 4 temporary Pickleball courts in tennis court #5 at Nealon Park are fully utilized, with several people waiting to play. It also allows multiple generations to socialize and play together. People in the community get to know each other playing Pickleball. This is never the case with tennis and we often see only 2 people playing in the other 4 tennis courts (#1 through to #4), while the Pickleball courts are packed. We should convert Nealon Park courts #3 and #4 into 6-8b permanent Pickleball courts and leave tennis court #5 as a shared court with tennis, but unless courts #1 and #2 are full, and courts #3 and #4 are not full, court #5 can be utilized for tennis.
49	More pickle ball courts, please!
50	The Parks and Recreation Commission serves no other purpose than to inform the city counsel of community needs. If it's just another committee gathering information without any decision making power, what would be the point of having this committee?
51	You should permanently convert Nealon courts #3 and #4 to pickleball, and use court #5 for dual usage. Pickleball is a much better use of space than the tennis courts -- 4X the number of people can play, so better value for the community.
52	pickleball has become very popular and there currently are no classes in MP, with limited court time. I have to go to Sunnyvale.; n/a
53	I would like to request the permanent conversion of courts #3 and #4 to pickleball in addition to court #5 being kept for dual usage
54	At Nealon Park, please consider permanent conversion of tennis courts three and four to pickle ball courts in addition to Keeping Court, #5 available for dual usage. Thank you!
55	I'm very happy to live in Menlo Park, I live modestly. I would like to see homelessness end.
56	Thank you for taking feedback .
57	<p>LOVE the no parking on street at night law, please keep it!</p> <p>What is your pest management plan, applicable to rodents? All the development will stir up rodent activity. Owl box program?</p> <p>Native plants only in new development? Plant milkweed? . . . Right, larger issues at hand.</p> <p>Water security - how will all the future water needs be met with this large escalation in residential development?</p>

All comments are shown as they were written and submitted by the respondents, and are numbered in the order they were received.

Q17. Please tell us any other ideas, needs, complaints or suggestions you'd like to share with us.	
	<p>I'm a Menlo Masters swimmer who moved to this area (Belle Haven) bc of Menlo Masters at Burgess. Prior to moving here and during COVID shutdowns, I continued paying full team dues when the facility was closed. If permitted, I would have continued paying in full during the entire shut-down to help ensure the costs of running the pool and paying staff were covered. As a Masters swimmer, I can say that Menlo Masters was the only team running in the Bay Area for several months, the facility was run in a safe, orderly manner. Pool access was fair and reasonable -- for Menlo Masters lanes we had to sign up at midnight, a horrible time slot that's equally bad for everyone, which I thought was fair.</p> <p>As recently as this summer, the performance pool was shut down for maintenance and I am so impressed by how the competition pool adjusted to address the needs of performance pool users. The swim team consolidated lanes to accommodate lap swimmers (swim practice lanes were crowded and I was fine with it), pool temp was warmer to also accommodate lap swimmers/aqua-robics/PT. We were advised that lap swimmers come first, as they should. When practice is over, we are instructed to immediately get out to ensure the lap swimmer has access and I personally have had only positive encounters with lap swimmers at this pool.</p> <p>To my knowledge, based on conversations with lifeguards and administrative staff - Tim Sheeper treats his employees well and he has a loyal base of lifeguards, which is essential during the lifeguard shortage we are experiencing throughout the US right now.</p> <p>The hours of operation have been accessible - I have tons of pool access as a resident and masters swimmer. The stability of this pool is unmatched - I have yet to be on a team where I can confidently rely on staff showing up, clean facility, pool being open and in working condition, and having a nice experience with the folks who attend.</p> <p>It is my understanding that the city wants to renew Sheeper's contract on an annual basis; however, I don't think that is a helpful approach- short term contracts create uncertainty; they lack the time or stability necessary to develop a solution to existing problems (i.e. the accessibility issue is anecdotal at this stage, a multi-year contract will facilitate the creation of data/ tracking needed for crafting a solution to this problem, such as developing programs that directly address the concerns and it's worth noting that Tim is well-connected enough to obtain resources needed to address). Short-term contracts adversely impact employee stability/morale and also can confuse residents if there is ownership change/different tone at the top. I see that 5-years may be too uncomfortable, perhaps 3-year could be a compromise?</p> <p>Please feel free to contact me if there's anything I can do to persuade Menlo Park to keep Tim Sheeper in charge of operations of Burgess. I am not exaggerating when I say that this team, this facility, is what attracted me to buy my first</p>
58	
59	My biggest concern is why is the city council discussing the Burgess pool management/program since it is the facility that attends most of the residents with excellent programs for all ages, instead of is focusing on how to replicate the same success in the gymnasium?
60	The idea that you are even soliciting complaints is very telling. Hire the best professionals. Let them do their jobs Pay them well with these taxpayer dollars. We can afford to do that in one of the wealthiest counties in the country. Listen less to those who complain and survey more often your satisfied residents.
61	I read some place that libraries are one of the few remaining public spaces where people are allowed to just be. I think it's important to preserve libraries as just that.
62	More dedicated dog parks, and dog parks with seating for the humans please and water fountains for both pups and people. Also grass, fake or otherwise is much better for pets and owners alike. Secondly, a park similar to the Magic Bridge in Palo Alto with structures and play items that have children with limited abilities in mind would be wonderful.
63	The current controversy over the pool management is unfortunate and does not inspire confidence in city management.
64	For a city of Menlo Park's caliber - our parks are dirty, our fields sub par. Would be wonderful to see these restored and higher maintenance standards given we have so few we should take good care of them. Some new landscaping/drought tolerant in the downtown parks especially the park across from Draeger's that hosts concerts and city events would be wonderful. Keeping the sidewalks more clean downtown would also be lovely.
65	Nothing else to comment on since I stated it earlier in the survey.
66	Addition to survey previously sent: So very disappointed to learn about the removal of >60 old and healthy trees to make way for the Flood Park development, with another >30 to be removed later. You really don't get it, do you? Why are so many fertilized, watered, pesticided large playing fields needed? Old trees, all trees are far more important. Menlo Park is a Tree City? Shameful destruction of CO2 trapping ecosystem and oxygen producers for no good reason other than selfish human profit. Same comments for SRI development, as we dive into drought. Don't worry, the status quo may last your lifetime . . . not your descendants, though.
67	The woodchips at the willows dog park prevent the dogs from playing well together since the dogs do not like to run on the chips. If we could figure out another solution for dogs to have grass or turf access in the evenings that would be better. Also there is no water fountain for the dogs in the Willows dog park.
68	Not enough classes for kids (4-12) on weekends

All comments are shown as they were written and submitted by the respondents, and are numbered in the order they were received.

Q17. Please tell us any other ideas, needs, complaints or suggestions you'd like to share with us.	
69	See above
70	I encourage people to look at the complexity of running a solvent aquatics program. Very few municipal pools are able to cover their operating costs. Menlo has found a model which allows that where incentives are in place to make the best and highest use of the facility and deliver the best customer service. The pool requires significant ongoing hiring for seasonal employees and part time employees, a registration and billing system, a website and IT behind the integrated technologies, customer service, safety and compliance considerations and ongoing marketing. This is a significant enterprise that has been built over time to serve the community and is not easily replaced. The existing program is flexible and adaptable to the community needs and continues to operate with the community in mind
71	I have been very happy with the programs offered by the city (with the exception of programs cut because the gym is closed). Please don't change anything.
72	I wish the Menlo Park library would integrate itself into a sharing system with the San Mateo County library. Its' very frustrating to see items in the catalog that aren't available to me as a Menlo Park resident.
73	add more sports, fix liebsity (for mobile), for cpearity.
74	Stop sending me stuff in Spanish--may I have things sent in English please?
75	Library can organize global student book exchange programs w/ other libraries around the world. This is a richer community so can attract revenue
76	y ou are doing a great job
77	Filling this out for Pickelball. More public courts are needed.
78	It's great when courts are able to support either tennis or pickleball!
79	More pickleball courts.
80	Pickleball is great for all ages; low barrier to entry; intersections across political and socioeconomic groups;
81	?
82	Pickleball serves not just Menlo Park residents, but the surrounding areas as well! Playing with our neighbors from the Peninsula is good community building for all!
83	nothing
84	Make sure Belle Haven is given similarly resourced library & rec. access given the influx of new residents w/ high density housing.
85	More outside (outdoor) community events to make neighbors meet each other. Organizing camp out at a park with a program about stars or planets for example. Programs to help people grow food in their yards instead of grass.
86	Replace one of the corner markets on newbridge or ivy to a safeway or trader joes. Fix the light on ivy, it takes so long to turn green.
87	-Open up a more grand inclusive way to public art. We have a lot of kids that are shy to share. The Sunset fest was always a good escape.
88	Make sure there is Always a cross guard for the children, going to and from school. Keep it safe
89	n/a
90	The San Mateo Library system is truly outstanding!
91	Tree trimming, especially in East Menlo
92	A proper dog park is needed in the Belle Haven area
93	Menlo Park needs a larger dog park with grass or turf. The small parks with dirt/rocks/mulch/etc. are not good enough.
94	Thank you for undertaking this survey
95	Organized adult trips/tours would be nice. More music and poetry programs. One day workshops for folks who can't do long classes. More life skills-type classes (budgeting, investing, saving)
96	Build a better library. Surrounding cities have new libraries with multi-purpose spaces & are bright and cheery, the main library is a morgue
97	That the Belle Haven neighborhood have the same opportunities as Menlo Park residents
98	-It would be nice to have a ping pong table -another pool table -variety of classes, other activities
99	For the street cleaners, I thank you. Hope this will continue sometimes.
100	For the new Onetta Harris Facility, I hope that the residents that live in the Belle Haven Community will have priority over Western MP residents.
101	The Belle Haven Library doesn't print images anymore. I shouldn't have to pay for parking tickets to park in front of my apartment. At least for the people who have minimum of one parking space.
102	I hope that our library has reviewed and strengthened protections against discriminatory book ban requests. Book talk book club (or recommendation wall with optional pics of recommender with book)
103	Love having the east menlo sr. center this side of the freeway + open. Most beneficial for many. Wish it would stay.

All comments are shown as they were written and submitted by the respondents, and are numbered in the order they were received.

Q17. Please tell us any other ideas, needs, complaints or suggestions you'd like to share with us.	
104	I love the library + classes at the center encourage groups to use the facilities for their galas, parties, meetings as an extra source of income
105	n/a
106	n/a
107	n/a
108	having hard time to get housing (subsidized housing for seniors)
109	todo bien
110	libros para personas mayores
111	N/A
112	Que ofrescan un group de libros (5) y dejar que los leeve a la case y luego un breve disenro de lo leído para despertar mas interes por leer.
113	Todo esta bien
114	Programer curso de ingeles, tanto para principates como para perfrcionalo
115	It'd be great if there's a place for people to make book suggestions.
116	mas cajas postales mas postes de luz en la noche plantar mas arboles
117	*The free shuttle *Wish there were lighted tennis courts in Bellhaven area. Thank you for removing those white posts along Newbridge, they were a bicycling hazard.
118	Spread the word more so that everyone knows what is out there
119	We don't need more buildings in or around our community.
120	So much of this recreation and programming is excellent and it's hard to choose between them. If you need more money to support these wonderful things, you should take it out of the Menlo Park Police Department budget.

All comments are shown as they were written and submitted by the respondents, and are numbered in the order they were received.



MENLO PARK COMMUNITY CAMPUS

SUSTAINABILITY OVERVIEW JUNE 22, 2022

CITY OF MENLO PARK
META PLATFORMS
HART HOWERTON
PAE ENGINEERS
DCI ENGINEERS
KPF ENGINEERS
STOK
OPTONY / ENGIE SA



Menlo Park Community Campus | Final Planning Submittal Rendering - Arrival

HART HOWERTON



Sustainability

The City Council declared a climate emergency committing to accelerating actions to address climate change at a local level and adopted a 2030 Climate Action Plan with the bold goal to be carbon neutral (zero emissions) by 2030. The Sustainability Division leads and/or supports implementation of the Climate Action Plan within the organization and the community at large.

Currently, there are six Climate Action Plan strategies:

- **Electrify 95% of existing buildings**
- Increasing electric vehicle usage and decreasing gasoline
- **Expand access to electric vehicle charging** for multifamily and commercial properties
- Reduce vehicle miles traveled by 25%
- **Eliminate the use of fossil fuels from municipal (city) operations**
- Develop a climate adaption plan to protect the community from sea level rise and flooding



MENLO PARK COMMUNITY CAMPUS

Key Project Sustainability and Resilience Goals

All Electric, Zero Combustion, Net Zero Energy Project

USGBC LEED Platinum Certification

On Site Renewable Energy Generation

Naturally Daylit Spaces

Healthy and Sustainable Materials and Finishes



- | | | |
|--|------------------------------|-------------------------------|
| A Menlo Park Community Campus Building | F Bicycle Parking | K Parking Lot |
| B Boardwalk | G Outdoor Dining Terrace | L Pool Area |
| C Playground | H Community Terrace & Garden | M Samtrans Bus Stop & Layover |
| D Existing Redwood Trees to Remain | I Service Area | N Fire Access Lane |
| E Children's Outdoor Courtyard | J Pedestrian Pathway | |

Proposed Site Plan



 0 60 120'

 1" = 60' at 11" x 17"

 October 8, 2021

 HART HOWERTON

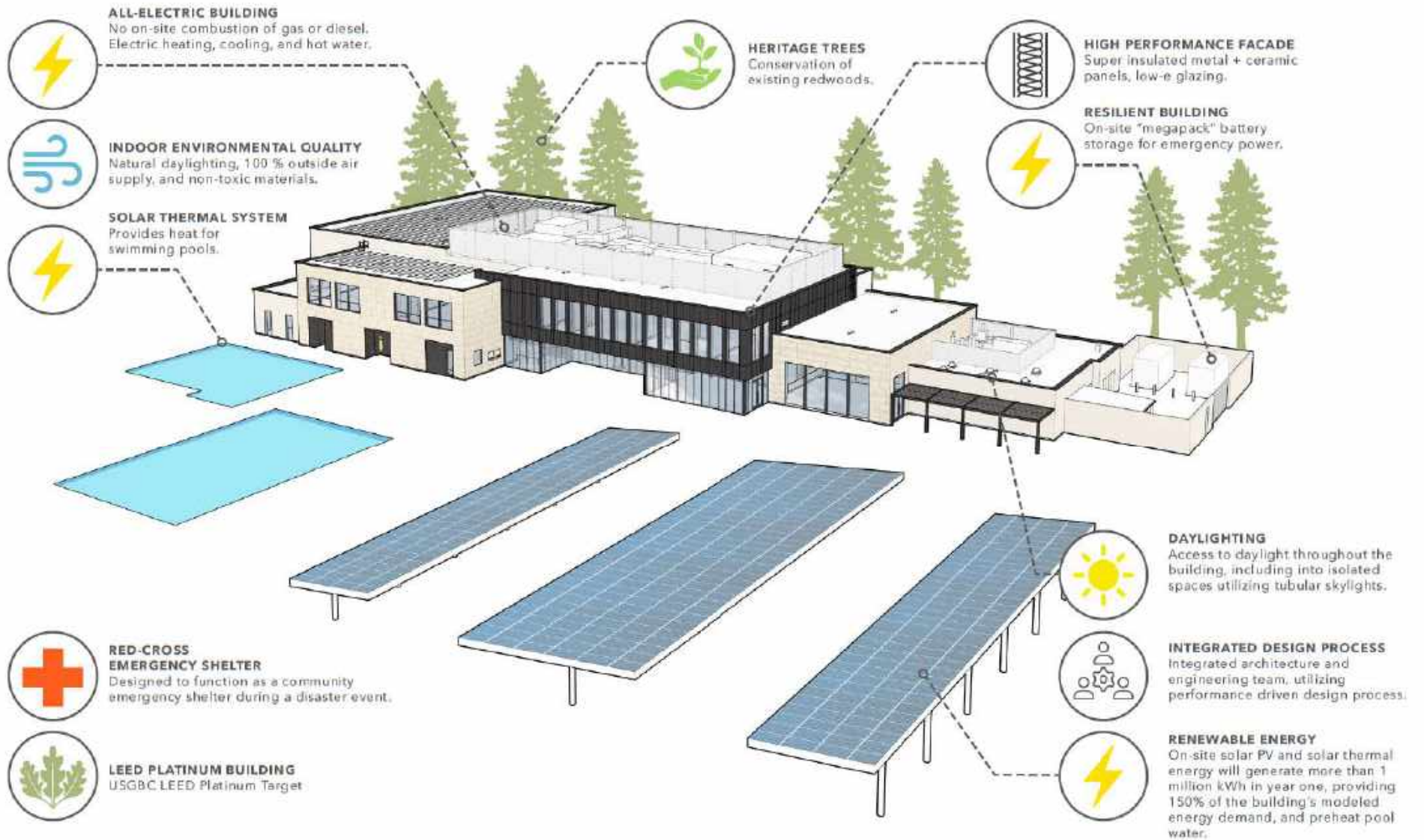

A Sustainable and Resilient Community Campus

HART HOWERTON

stōk LEED NC v4 SCORECARD

Menlo Park Community Campus

AWARDED	Likely	Pursuing	NO	Phase	Credit Name	Points Available
1				Prereq	Integrative Process - In design phase, achieve synergies between building, energy AND water related systems	1
Totals						
1	16			Credit	LEED for Neighborhood Development Location - Locate within LEED ND certified development subboundary	16
1				Credit	Sensitive Land Protection - Develop on previously developed land or follow criteria for non-sensitive	1
		2		Credit	High Priority Site - Locate project on high priority historic district, priority designation or transit	2
2		3		Credit	Surrounding Density & Diversity - Site within 1/4 mile of surrounding density criteria and/or a 1/2 mile of diverse uses	5
		5		Credit	Access to Quality Transit - Locate functional entrance within 1/4 mile of existing transit or 1/2 mile of planned transit services	5
1				Credit	Bicycle Facilities - Provide a bikeway and storage area	1
1	1			Credit	Reduced Parking Footprint - Don't exceed minimum local code requirements for parking capacity	1
1				Credit	LEED v4.1: Electric Vehicles - 5% of spaces or 25% discount for parking and electric car charging OR liquid, gas or battery facilities	1
Totals						
0	1	16				16
REQUIRED						
				Prereq	Construction Activity Pollution Prevention - Implement an erosion control plan, per the EPA CDP v2012	NA
1				Credit	Site Assessment - Complete site survey including topography, hydrology, climate, vegetation, soils, human use, human health	1
1	1	1		Credit	Site Development - Protection or Restore Habitat - On-site restoration OR financial support	2
1				Credit	Open Space - Provide outdoor space/water that is equal to 30% of total site area, 25% of which is vegetated	1
2		1		Credit	Rainwater Management - Manage runoff for at least the 95th percentile of local rainfall events	3
2				Credit	Heat Island Reduction - Meet normal and roof orders OR provide a minimum of 75% parking spaces under cover	2
1				Credit	Light Pollution Reduction - Spotlight uplight glare method calculation method, exterior luminance and signage/clock	1
Totals						
7	1	2				10
REQUIRED						
				Prereq1	Outdoor Water Use Reduction - Permanent non-irrigated landscape OR reduce water use 30% for peak water month	NA
				Prereq2	Indoor Water Use Reduction - Reduce aggregate water use by 30% for fixtures and fittings	NA
				Prereq3	Building-Level Water Metering - Install permanent water meters that measure potable water use, share data with USGBC	NA
1		1		Credit	Outdoor Water Use Reduction - Reduce water use no irrigation or reduced irrigation 50% - 100%	2
0				Credit	Indoor Water Use Reduction - Reduce fixture and fitting water use by 25% - 50%	0
		2		Credit	Cooling Tower Water Use - Conduct a one-time potable water analysis, measure control parameters in Table 1	2
1				Credit	Water Metering - Meters for 2 or more water subsystems: irrigation, indoor plumbing, hot water, boiler, reclaimed water, or other	1
Totals						
0		3				3
REQUIRED						
				Prereq1	Fundamental Commissioning and Verification - Commissioning for ASHRAE 9-2009 and 1.1-2007	NA
				Prereq2	Whole-Building Energy Performance - Whole building energy simulation OR ASHRAE 90.1 Design Guide OR ABCPS	NA
				Prereq3	Building-Level Energy Metering - Use building-level energy meters or submeters that can aggregate building-level data	NA
				Prereq4	Fundamental Refrigerant Management - Do not use CFC-based refrigerants in HVAC/R systems, or have a phase-out plan	NA
0				Credit	Enhanced Commissioning - Implement systems commissioning or monitor-based commissioning	0
16				Credit	LEED v4.1: Optimize Energy Performance - Whole building energy simulation or follow ASHRAE Advanced Energy Design Guide	16
1				Credit	Advanced Energy Metering - Install advanced energy metering for whole building and individual energy sources	1
		2		Credit	Demand Response - Participate in existing demand response program or provide infrastructure for demand response programs	2
5				Credit	LEED v4.1: Renewable Energy - Use on-site or off-site renewable energy to offset greenhouse gas emissions for annual energy use	5
		1		Credit	Enhanced Refrigerant Management - Refrigerants w/ ODP of 0 and GWP of less than 20 OR calculate refrigerant impact	1
Totals						
20		3				33

AWARDED	Likely	Pursuing	NO	Phase	Credit Name	Points Available
				Prereq	Storage and Collection of Recyclables - Dedicated areas for waste collection, collection and storage	NA
				Prereq	Construction and Demolition Waste Management Planning - Estimate C&D waste-diversion goals	NA
1	1	3		Credit	Building Life-Cycle Impact Reduction - Historic building reuse, renovate high end building OR whole building LCA	5
2				Credit	LEED v4.1: Building Product Disclosure and Optimization - Environmental Product Declarations	2
1	1			Credit	LEED v4.1: Building Product Disclosure and Optimization - Material Ingredients	2
2				Credit	LEED v4.1: Building Product Disclosure and Optimization - Sourcing of Raw Materials	2
2				Credit	C&D Waste Management - Divert 50% (3 streams), 75% (4 streams) OR 2.5 lbs waste per square foot	2
Totals						
0	2	5				15
REQUIRED						
				Prereq	Minimum Indoor Air Quality Performance - Meet ASHRAE 62.1-2010	NA
				Prereq	Environmental Tobacco Smoke Control - Prohibit smoking indoors, restrict outdoor smoking within 25 feet	NA
2				Credit	Enhanced Indoor Air Quality Strategies - Comply with enhanced IAQ strategies	2
0				Credit	LEED v4.1: Low-Emitting Materials - Achieve level of compliance for product categories or use budget calculation method	0
1				Credit	Contract an IAQM Plan - Implement IAQM & provide materials and equipment during construction	1
2				Credit	Indoor Air Quality Assessment - Before and during occupancy flush-out OR conduct baseline IAQ testing	2
1				Credit	Thermal Comfort - Meet requirements for ASHRAE 55-2010	1
1	1	1		Credit	Interior Lighting - Lighting Controls for 90% plus individual occupant spaces & four lighting quality strategies	2
1	1	1		Credit	Daylight - Install gas control devices, spatial daylight autonomy, illuminance calculations OR daylight flow area requirement	3
1				Credit	Quality Views - Vision glazing for 75% of regularly occupied floors with at least two kinds of view types	1
1		1		Credit	LEED v4.1: Acoustic Performance - Meet requirements for HVAC noise, sound isolation, reverberation time, & sound masking	1
Totals						
12	1	5				16
REQUIRED						
1				Credit	On-Site Stormwater Management - Green Cleaning & IPM	1
1				Credit	Integrative Analysis of Building Materials (or EPD0 EP1, Other EP)	1
1				Credit	Climate Products (or EPD0 EP1, Other EP)	1
1				Credit	Green Education	1
1				Credit	v4.1 Purchasing Limits - Low Mercury Lighting	1
1				Credit	LEED Accredited Professionals	1
Totals						
6						6
*Innovation at Design includes Exemplary Performance credits						
REQUIRED						
1				Credit	Optimize Energy Performance	1
1				Credit	EPD0 - Sourcing of Raw Materials	1
1		1		Credit	Rainwater Management	1
1				Credit	Indoor Water Use Reduction	1
1				Credit	Access to Quality Transit	1
1				Credit	Building Life Cycle Impact Reduction	1
Totals						
3		3				4

Confirmed Certification Level:
 Awarded + Likely Certification Level: **PLATINUM**
 Awarded + Likely + Pursuing Certification Level: **Platinum**

Awarded Points
 GOLD / PLATINUM PURSUIT (Awarded + Likely Points) **80**
 PLATINUM PURSUIT (Awarded + Likely + Pursuing Points) **85**

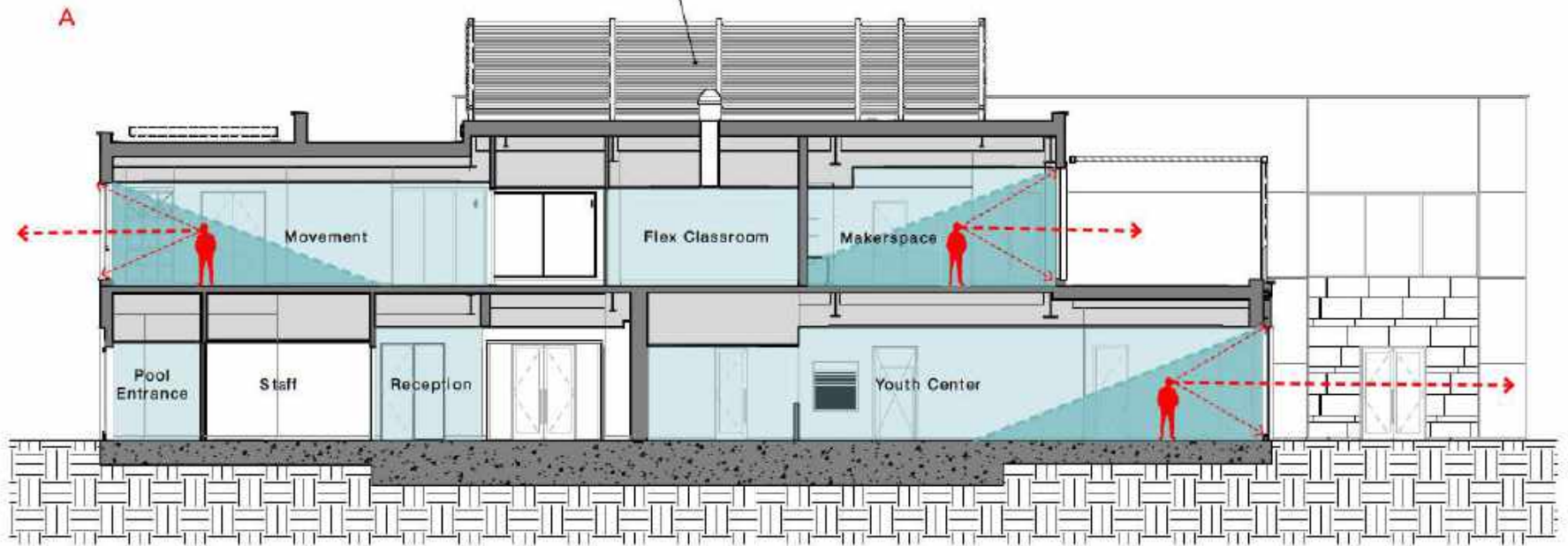

Design for Natural Daylight and Views

Menlo Park Reach Codes

“The 2019 California Building Standards Code and the California Code of Regulation will take in effect on January 1, 2020. The City of Menlo Park adopted groundbreaking local amendments to the State Building Code that would **require electricity as the only fuel source for new buildings** (not natural gas).”

Energy Intensity Unit (EUI) Defined:

“Energy use intensity (EUI) is an indicator of the energy efficiency of a building’s design and/or operations. EUI can be thought of as the miles per gallon rating of the building industry.”

<https://aiacalifornia.org/energy-use-intensity-eui/>

Site Energy Use Intensity (EUI)

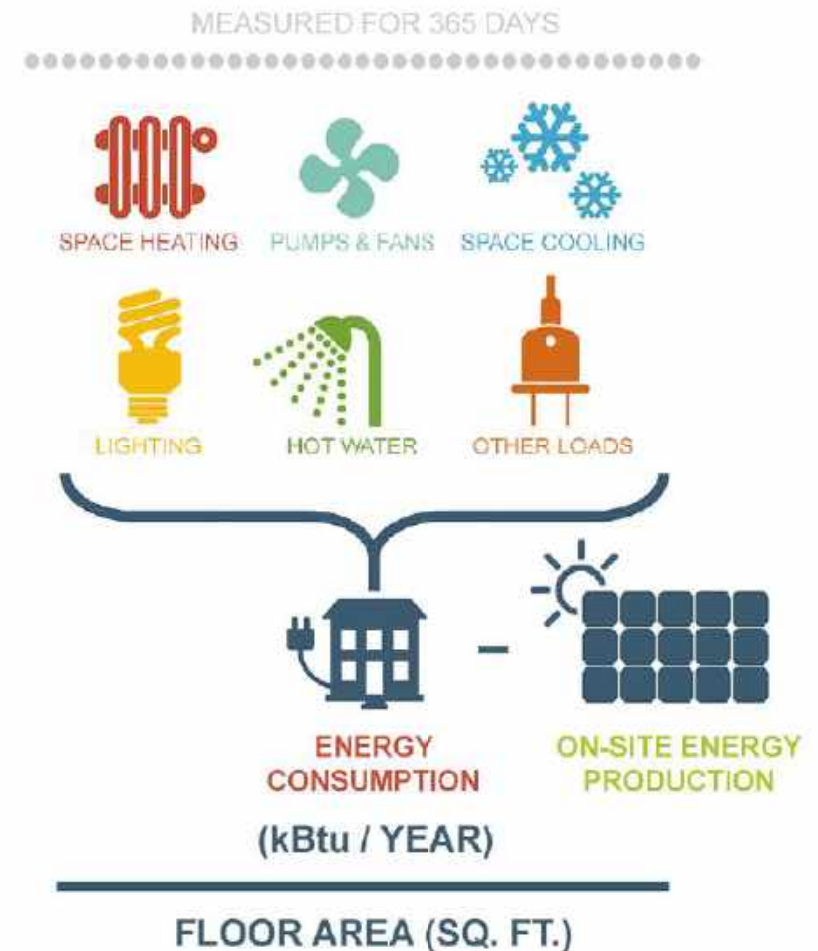

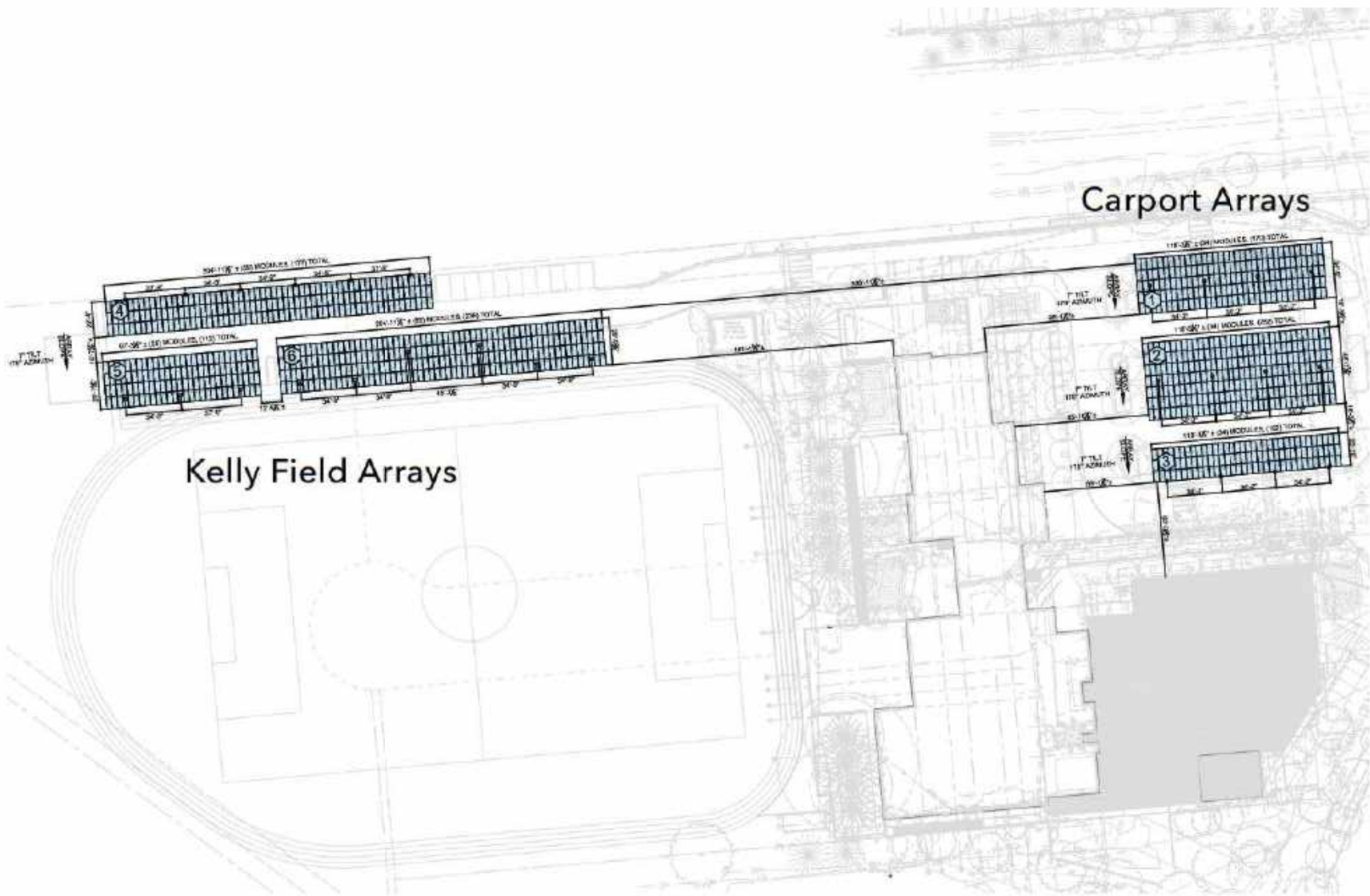

Solar Photovoltaic / Solar Thermal Arrays at Kelly Field + Carports

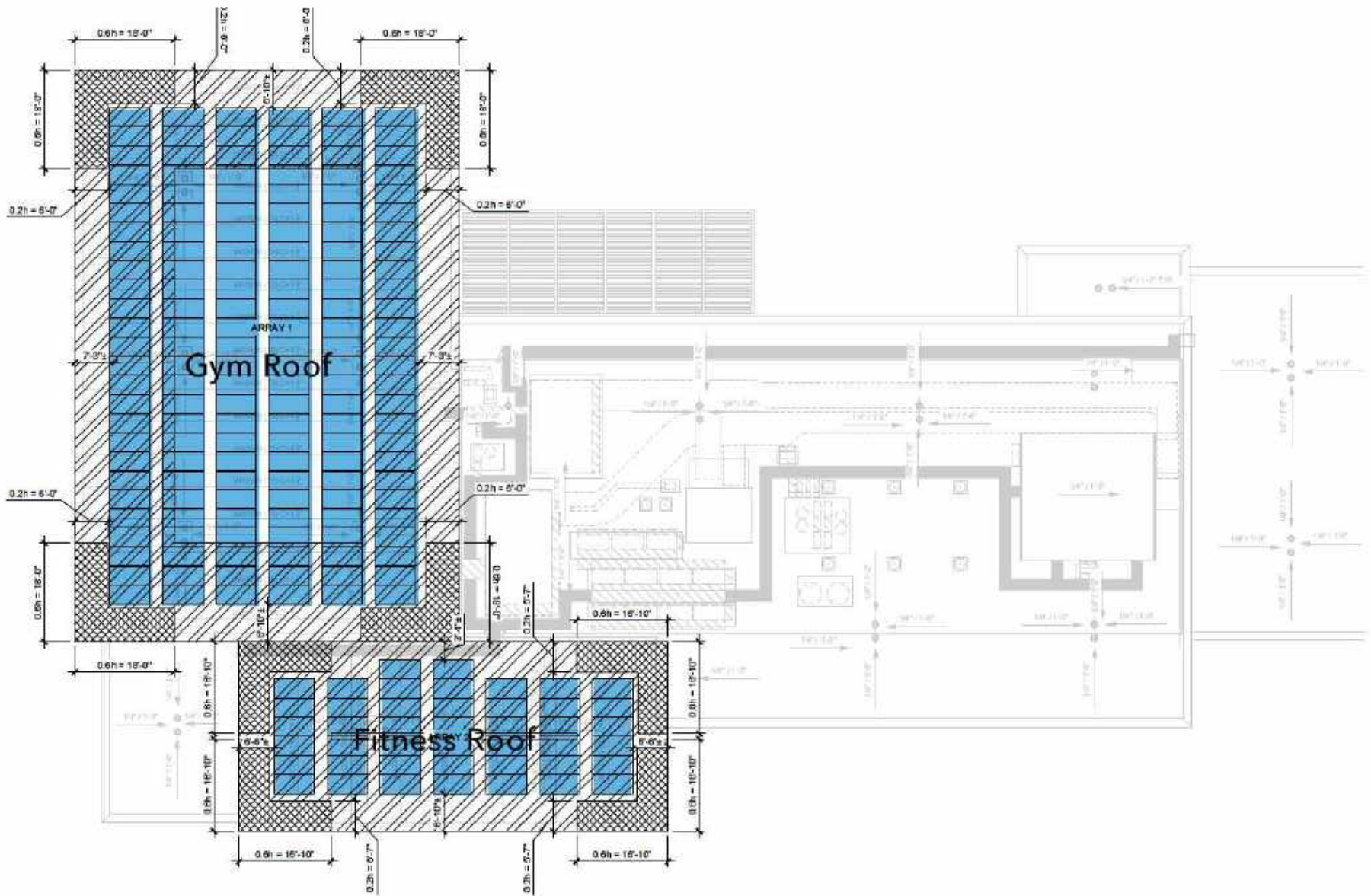

Solar Photovoltaic Arrays at Rooftops

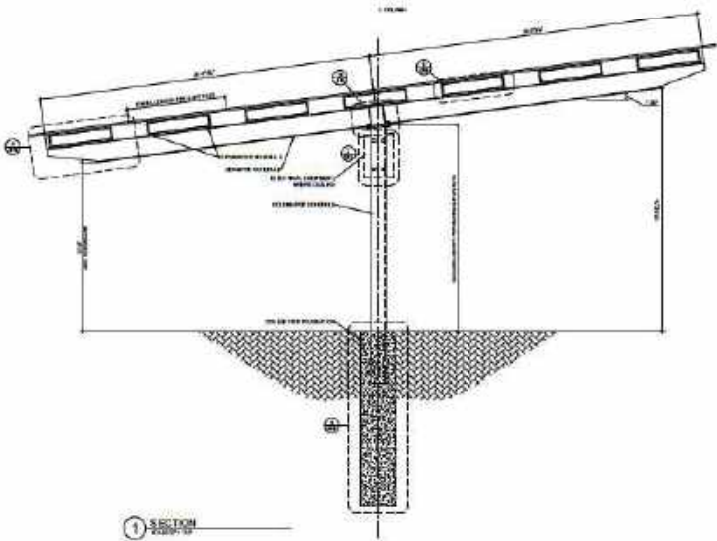

Solar Photovoltaic + Solar Thermal Arrays

Heat from Sun

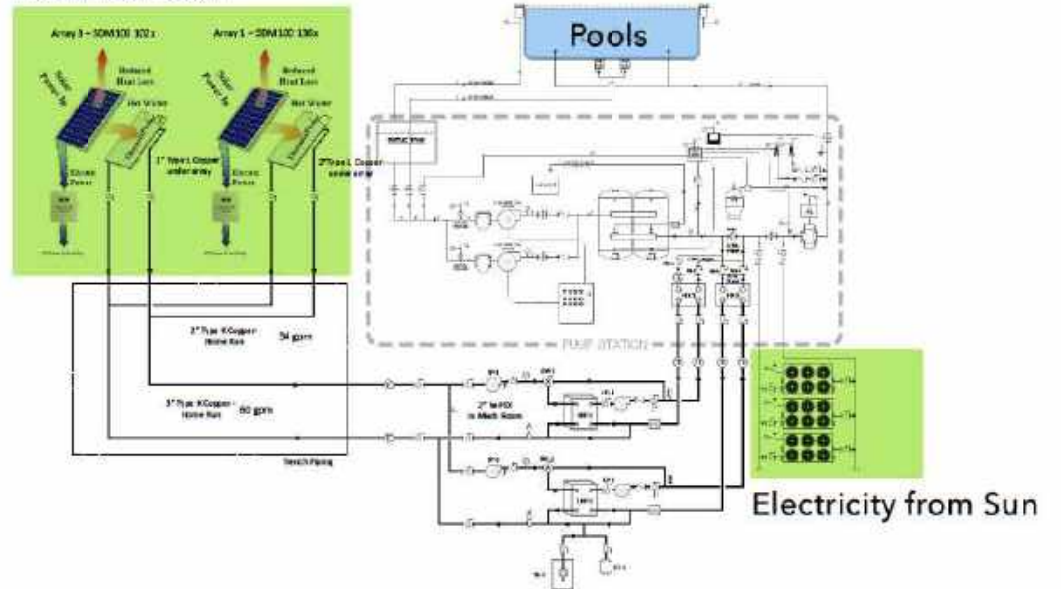

THE MENLO PARK COMMUNITY CAMPUS MICROGRID

Microgrid Defined:

"a small network of electricity users with a local source of supply that is usually attached to a centralized national grid but is able to function independently."



THE MEGAPACK

Applications:

- Renewable Smoothing
- T&D Investment Deferral
- Voltage Support
- Capacity Support
- Microgrid
- Market Participation
- Frequency Regulation



<https://www.tesla.com/megapack>

HART HOWERTON

"... study by the Northeast Energy Efficiency Partnerships found that when units designed specifically for colder regions were installed in the Northeast and Mid-Atlantic regions, the annual savings are around 3,000 kWh (or \$459) when compared to electric resistance heaters, and 6,200 kWh (or \$948) when compared to oil systems."

<https://www.energy.gov/energysaver/air-source-heat-pumps>



Air Source Heat Pumps

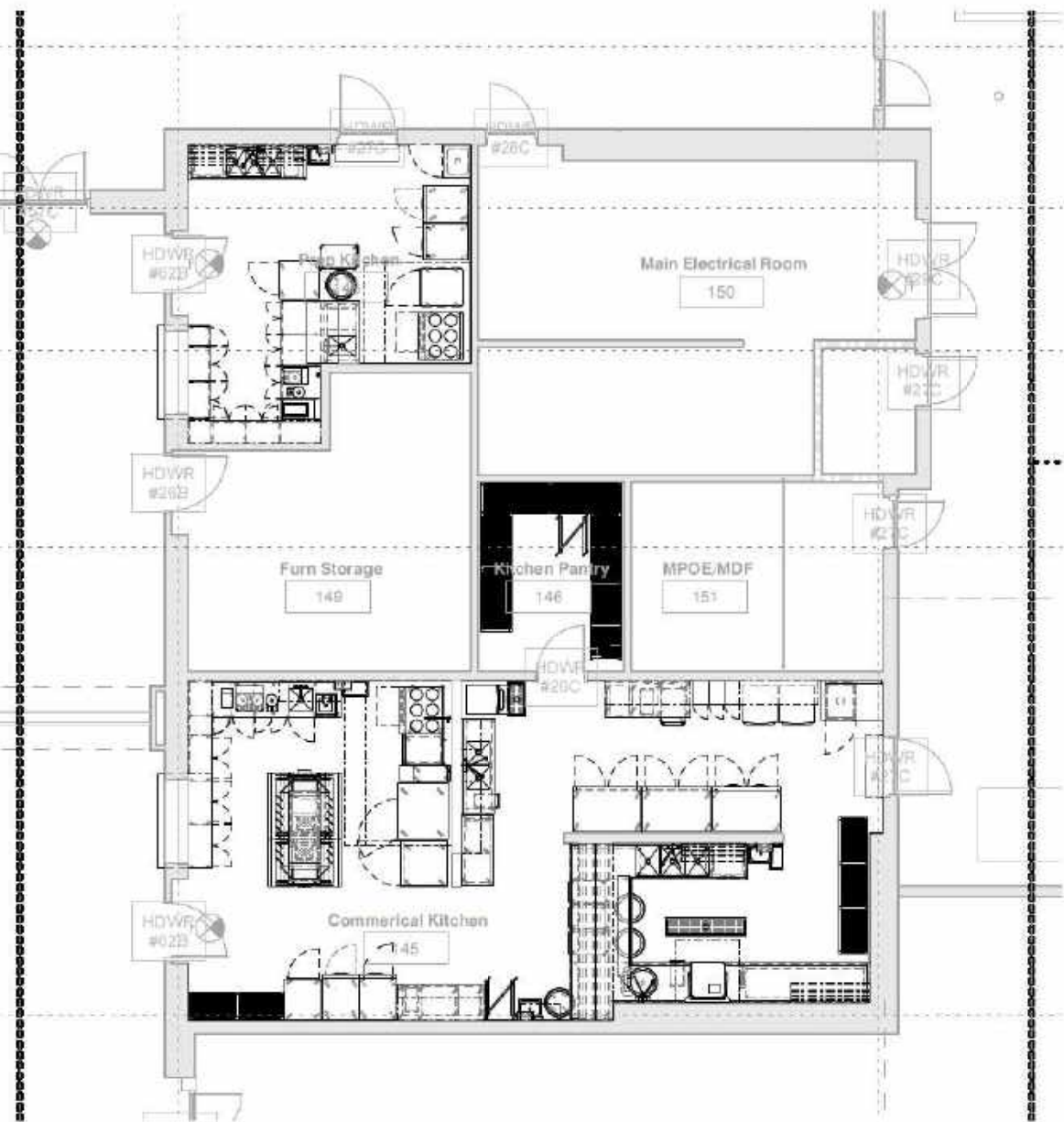

All-Electric Commercial Kitchen



Menlo Park Community Campus | Final Planning Submittal Rendering - Children's Terrace

HART HOWERTON



Questions





1 Senior Lounge 1

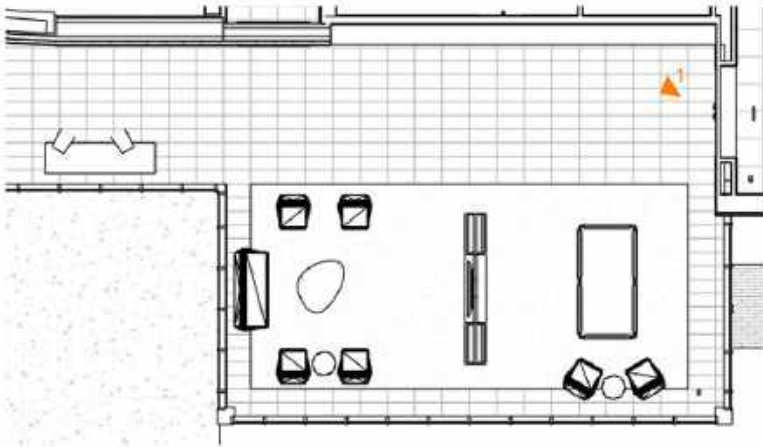



SENIOR LOUNGE
FIRST FLOOR



2 Children's Library 1



3 Children's Library 2





CHILDREN'S LIBRARY
FIRST FLOOR

Page F-1.83



4 Makerspace 1



5 Makerspace 2





MAKERSPACE
SECOND FLOOR

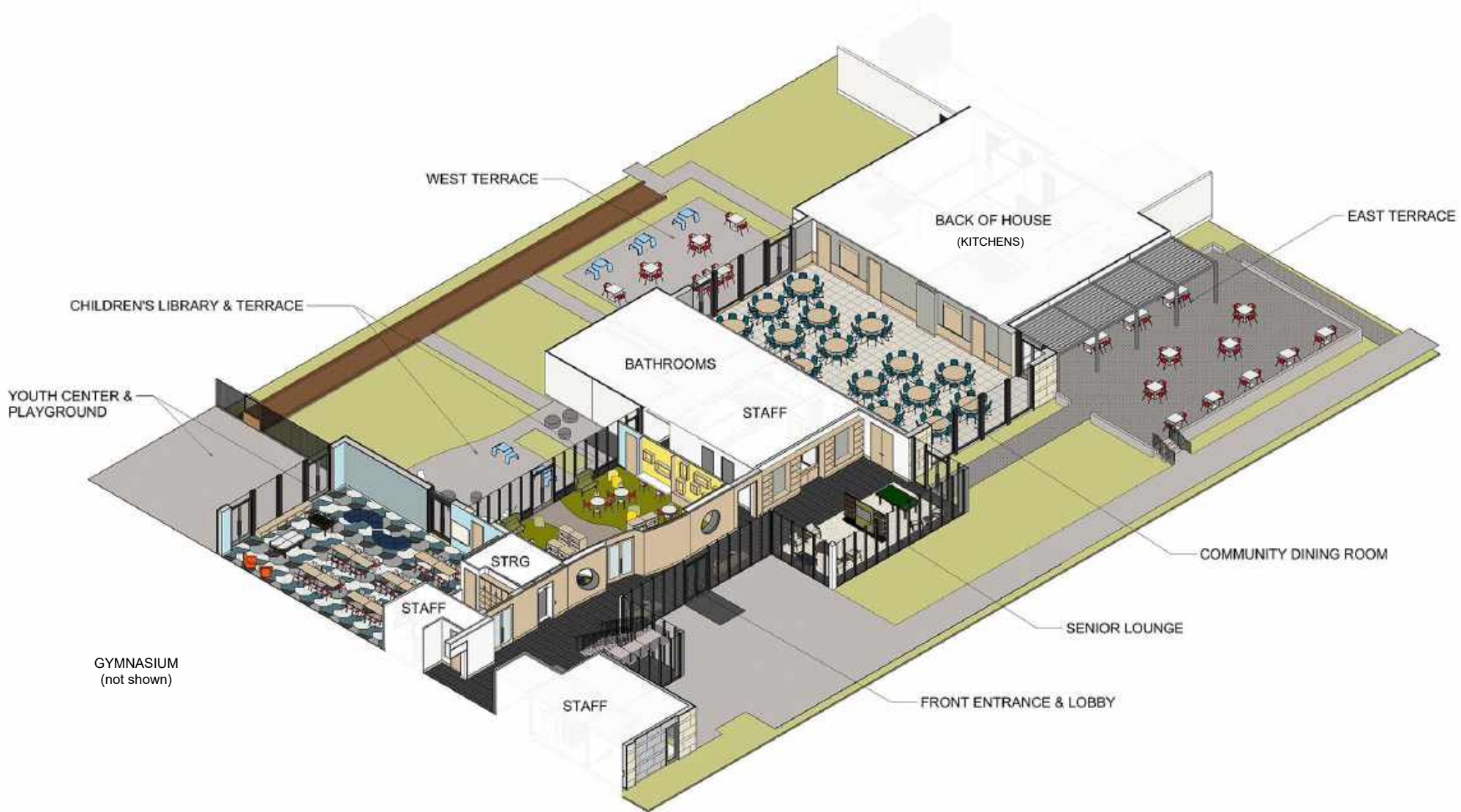

FIRST FLOOR

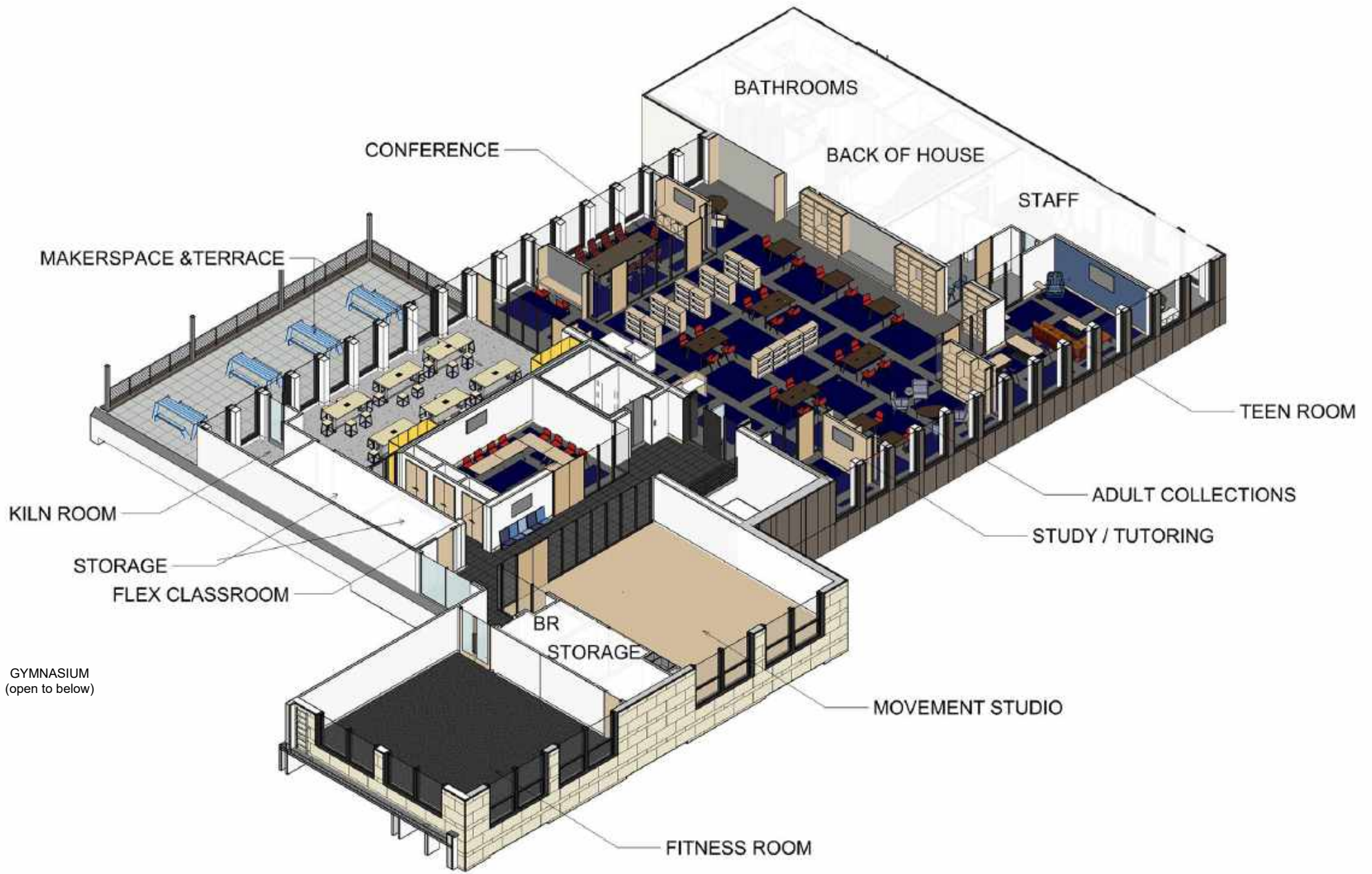

SECOND FLOOR