



# C.3 Regulated Projects Guide

For use by developers, builders and project applicants to design and build low impact development projects

Version 2.0 | November 2023



# Local Contacts

Contact information for the Countywide Program and each of the San Mateo County Permittees is given below. Please contact the local agency with any questions regarding requirements specific to the local jurisdiction.

Atherton: (650) 752-0541

Belmont: (650) 595-7425

Brisbane: (415) 508-2120

Burlingame: (650) 558-7230

Colma: (650) 757-8888

Daly City: (650) 991-8033

East Palo Alto: (650) 853-3197

Foster City: (650) 286-3270 / 286-3242

Half Moon Bay: (650) 726-7177

Hillsborough: (650) 375-7444

Menlo Park: (650) 330-6740

Millbrae: (650) 259-2339

Pacifica: (650) 738-7361 / 738-3767

Portola Valley: (650) 851-1700

Redwood City: (650) 780-7380

San Bruno: (650) 616-7065

San Carlos: (650) 802-4200

San Mateo: (650) 522-7300

County of San Mateo: (650) 421-3939 / 599-7310

South San Francisco: (650) 877-8555

Woodside: (650) 851-6790

SMCWPPP-C/CAG: (650) 599-1433

# Credits

The Countywide Program extends appreciation to all who contributed to this document, which was developed under the guidance of the New Development Subcommittee. We appreciate the comments, suggestions, and guidance provided by the Subcommittee members listed below.

Photo (cover), courtesy of City of Burlingame.

## New Development Subcommittee Representatives (as of June 30, 2023)

Reid Bogert, SMCWPPP Program Director

James O'Connell, NDS Chair, Redwood City

---

Ralph Robinson, Atherton

Elizabeth Wada, Belmont

Julia Ayres, Brisbane

Jennifer Lee, Burlingame

Alvin Jen, Colma

Sibely Calles, Daly City

Michelle Daher, East Palo Alto

Taniela Mapa, Foster City

Jonathan Woo, Half Moon Bay

Doug Belcik, Hillsborough

Rambod Hakhamaneshi, Menlo Park

Nicole Tandel, Millbrae

James Lin, Pacifica

CheyAnne Brown, Portola Valley

Matt Neuebaumer, San Bruno

Vatsal Patel, San Carlos

Sven Edlund, City of San Mateo

Andrew Wemmer, South San Francisco

Sean Rose, Woodside

Camille Leung, County of San Mateo

Krista McDonald, County of San Mateo

Noah Katz, SMC Resource Conservation District

The Program recognizes the firms that helped prepare this document. EOA, Inc., as the consultant to the New Development Subcommittee, coordinated and compiled information, wrote all sections not written by others, and assisted with overall document preparation. Sarah Sutton of Placeworks prepared the planting guidance and the 2016 Plant List. David Smith, formerly with the Interlocking Concrete Pavement Institute, provided comments on pervious pavement, Section 6.6.

The Program gratefully acknowledges the public agencies whose post-construction stormwater guidance documents served as inspiration and models for this document, including the Alameda Countywide Clean Water Program's C.3 Stormwater Technical Guidance; the Contra Costa Countywide Clean Water Program's C.3 Stormwater Guidebook; the Santa Clara Valley Urban Runoff Pollution Prevention Program's C.3 Stormwater Handbook and GSI Handbook; Portland, Oregon's Stormwater Management Manual; and SMCWPPP's Green Infrastructure Design Guide, prepared by Community Design + Architecture and Urban Rain Design. This update is dedicated in memory and appreciation of the contributions of Kevin Robert Perry from Urban Rain Design.

# Table of Contents

Glossary of Terms.....	i
Chapter 1: Introduction – How to Use this Guide .....	1-1
1.1 Purpose of this Guide .....	1-2
1.2 What is the Countywide Program? .....	1-4
1.3 How to Use this Guide? .....	1-5
1.4 Precedence .....	1-7
Chapter 2: Background and Regulatory Requirements .....	2-1
2.1 Stormwater Problems In Developed Areas.....	2-2
2.2 Low Impact Development Stormwater Control Measures .....	2-4
2.3 Municipal Stormwater Permit Requirements .....	2-6
Chapter 3: Preparing Permit Application Submittals .....	3-1
3.1 The Development Review Process .....	3-2
3.2 How to Prepare Planning Permit Submittals .....	3-4
3.3 How to Prepare Building Permit Submittals.....	3-17
3.4 Simple Instructions for Small Sites Subject to Stormwater Treatment Requirements .....	3-20
Chapter 4: Low Impact Development Site Design .....	4-1
Introduction .....	4-2
4.1 Self-Treating Areas .....	4-4
4.2 Self-Retaining Areas .....	4-7
4.3 Reducing the Size of Impervious Areas .....	4-9
4.4 Rainwater Harvesting and Use .....	4-11
4.5 Site Design Requirements for Small Projects .....	4-12

## Chapter 5: General Technical Guidance for Treatment Measures .....5-1

Introduction .....	5-2
5.1 Hydraulic Sizing Criteria .....	5-2
5.2 Applicability of Non-Low Impact Development (LID) Treatment Measures .....	5-13
5.3 Using Manufactured Treatment Measures.....	5-14
5.4 Using Treatment Trains .....	5-15
5.5 Infiltration Guidelines.....	5-16
5.6 Bypassing High Flows.....	5-17
5.7 Plant Selection and Maintenance.....	5-19
5.8 Mosquito Control .....	5-21
5.9 Incorporating Treatment with Hydromodification Management .....	5-22
5.10 Treatment Measures in Areas of Bay Fill .....	5-23
5.11 Treatment Measures in Seismic Hazard Areas.....	5-24
5.12 Artificial Turf and Stormwater Treatment .....	5-25
5.13 Getting Water into Treatment Measures .....	5-26
5.14 Underdrain.....	5-33
5.15 Integrating Trees and Stormwater Landscapes in Urban Areas .....	5-36

## Chapter 6: Technical Guidance for Specific Treatment Measures.....6-1

Introduction .....	6-2
6.1 Bioretention .....	6-5
6.2 Flow-through Planter .....	6-15
6.3 Tree Well Filter.....	6-23
6.4 Infiltration Trench .....	6-32
6.5 Extended Detention Basin .....	6-39
6.6 Pervious Pavement.....	6-46
6.7 Reinforced Grid Paving .....	6-55
6.8 Green Roof.....	6-62
6.9 Rainwater Harvesting and Use .....	6-67
6.10 Media Filter.....	6-74
6.11 Subsurface Infiltration System .....	6-79

Chapter 7: Hydromodification Management Measures.....	7-1
7.1 What is hydromodification?.....	7-2
7.2 Hydromodification Management (HM) Controls .....	7-4
7.3 Which Projects Need to Implement HM Controls? .....	7-6
7.4 Hydromodification Management (HM) Requirements.....	7-7
7.5 How to Implement HM Requirements .....	7-8
7.6 HM Control Design Process .....	7-11
7.7 HM Control Submittals for Review .....	7-13
7.8 Area-Specific HM Provisions .....	7-14
 Chapter 8: Operation and Maintenance .....	 8-1
Introduction.....	8-2
8.1 Summary of O&M Requirements .....	8-4
8.2 Preparing Maintenance-Related Documents.....	8-7
8.3 General Landscape Maintenance Activities .....	8-9
8.4 Specific Maintenance Activities by Treatment Measure .....	8-15
 Chapter 9: Alternative Compliance .....	 9-1
9.1 What is Alternative Compliance? .....	9-2
9.2 Categories of Alternative Compliance .....	9-3
9.3 Offsite or Regional Project Completion Deadlines .....	9-4
9.4 Alternative Compliance Options for Other Areas Requiring Stormwater Management.....	9-4
9.5 Alternative Compliance Case Study.....	9-6

## Appendices

A: Plant List and Planting Guidance for Landscape-Based Stormwater Measures.....	A-1
B: Example Scenarios .....	B-1
C: Treatment Measure Design Criteria Rainfall Regions and Mean Annual Precipitation for San Mateo County.....	C-1
D: Applicability of Inlet Filters, Oil/Water Separators, Hydrodynamic Separators, and Media Filters ...	D-1
E: Infiltration Guidelines.....	E-1
F: Mosquito Control Guidelines .....	F-1
G: Operation and Maintenance Document Templates .....	G-1
H: Areas Subject to Hydromodification Management Requirements .....	H-1
I: Guidance on Determining Feasibility and Sizing of Rainwater Harvesting Systems .....	I-1
J: Special Projects.....	J-1
K: Biotreatment Soil Media Specifications.....	K-1
L: Site Design Requirements for Small Projects .....	L-1

## List of Tables

<i>Table 2-1: Summary of Regulated Project Types and Thresholds</i>	2-9
<i>Table 2-2: Applicability of Pavement Maintenance Activities</i>	2-10
<i>Table 2-3: Projects Excluded from Provision C.3 Requirements</i>	2-12
<i>Table 3-1: Planning Permit Submittal Checklist</i>	3-5
<i>Table 3-2: Table of Example Stormwater Source Controls</i>	3-15
<i>Table 3-3: Building Permit Submittal Checklist</i>	3-18
<i>Table 5-1: Flow and Volume Based Treatment Measure Designs</i>	5-4
<i>Table 5-2: Unit Basin Storage Volumes (Inches) for 80 Percent Capture Using 48-Hour Drawdown Time</i>	5-6
<i>Table 5-3: Flow-based Sizing Criteria Included in MRP Provision C.3.d</i>	5-7
<i>Table 5-4: Estimated Runoff Coefficients for Various Surfaces During Small Storms</i>	5-9
<i>Table 5-5: Class 2 Permeable Material Gradation Requirements</i>	5-35
<i>Table 6-1: Treatment Measures for which Technical Guidance is provided</i>	6-3
<i>Table 6-2: Recommended Locations for Treatment Measures</i>	6-4
<i>Table 6-3: Recommended locations for bioretention areas (rain gardens)</i>	6-6
<i>Table 6-4: Recommended locations for flow-through planters</i>	6-16
<i>Table 6-5: Recommended locations for tree well filters</i>	6-24
<i>Table 6-6: Recommended locations for infiltration trenches</i>	6-34
<i>Table 6-7: Recommended locations for extended detention basins areas</i>	6-40
<i>Table 6-8: Recommended locations for pervious pavement areas</i>	6-47
<i>Table 6-9: Types of Pervious Pavement and Possible Applications</i>	6-48
<i>Table 6-10: Recommended locations for reinforced grid paving</i>	6-57
<i>Table 6-11: Recommended locations for green roofs</i>	6-63
<i>Table 6-12: Recommended locations for rainwater harvesting systems areas</i>	6-68
<i>Table 6-13 Summary of Minimum Treatment and Water Quality Standards for Rainwater</i>	6-70
<i>Table 6-14: Recommended locations for media filters</i>	6-75
<i>Table 6-15: Recommended locations for subsurface infiltration systems</i>	6-80
<i>Table 7-1: HM Control Plan Checklist</i>	7-13
<i>Table A-1: Plant species suitability for different stormwater treatment measures</i>	A-5
<i>Table E-1: Infiltration Methods in Commonly-Used Stormwater Controls</i>	E-3
<i>Table I-1: Toilet-Flushing Demand Required for Rainwater Harvesting Feasibility per Impervious Acre</i>	I-8
<i>Table I-2: Required Cistern Volume and Demand per Acre of Impervious Area to Achieve 80% Capture with a 48-hour Drawdown Time</i>	I-11
<i>Table J-1: Category B LID Treatment Reduction Credits, Based on the Density of Development</i>	J-4



<i>Table J-2: Step 1 – Weighted Sum Calculation</i> .....	J-6
<i>Table J-3: Step 2 – Allowable Affordable Housing Credit</i> .....	J-7
<i>Table J-4: Location Credits for Category C, Affordable Housing</i> .....	J-7
<i>Table J-5: Density Credits for Category C, Affordable Housing</i> .....	J-8
<i>Table J-6: Minimized Surface Parking Credits for Category C, Affordable Housing</i> .....	J-8
<i>Table L-1: Regional Fact Sheets and Corresponding Site Design Measures</i> .....	L-3
<i>Table L-2: Opportunities and Constraints for Site Design Measures</i> .....	L-4

## List of Figures

<i>Figure 1-1: The Countywide Program GreenSuite documents</i> .....	1-2
<i>Figure 2-1: The Water Cycle</i> .....	2-2
<i>Figure 2-2: Change in volume of stormwater runoff after development</i> .....	2-3
<i>Figure 2-3: Example of consequences of hydromodification</i> .....	2-3
<i>Figure 2-4: The four categories of stormwater control measures</i> .....	2-4
<i>Figure 3-1: Sample Development Review Process for projects subject to Provision C.3 requirements for site design measures, source controls and stormwater treatment measures</i> .....	3-3
<i>Figure 3-2: Turf block fire access road, Santa Clara University, Santa Clara</i> .....	3-9
<i>Figure 3-3: Playing Fields/Detention Area, Pacific Shores, Redwood City</i> .....	3-11
<i>Figure 3-4: Splash block/box and flow spreaders help prevent erosion as stormwater enters treatment measure</i> .....	3-15
<i>Figure 3-5: Flow-through planter in an urban setting</i> .....	3-21
<i>Figure 4-1: Self-Treating Area Usage</i> .....	4-5
<i>Figure 4-2: Commercial/Industrial Site Compared to Same Site with Self-Treating Areas</i> .....	4-5
<i>Figure 4-3: Schematic Diagram of a Site with a Self-Treating Area</i> .....	4-6
<i>Figure 4-4: Allowing some runoff from impervious surfaces to be retained and infiltrate in a “self-retaining” or “zero discharge” area can reduce the size of the required stormwater treatment measure</i> .....	4-8
<i>Figure 4-5: Schematic Drainage Plan for Site with a Self-Retaining Area</i> .....	4-8
<i>Figure 4-6: Installation of permeable interlocking concrete pavers in Oakland. Water infiltrates through gravel in the joints between the pavers</i> .....	4-9
<i>Figure 4-7: Parking Lifts in Parking Garage, Berkeley</i> .....	4-10
<i>Figure 4-8: Rainwater Harvesting Cistern at Mills College, Oakland</i> .....	4-11
<i>Figure 5-1: Stepped manhole design directs low flows to treatment measure and diverts high flows to storm drain system</i> .....	5-16
<i>Figure 5-2: StormGate™ proprietary flow splitter structure</i> .....	5-17
<i>Figure 5-3: Details of flow splitter boxes</i> .....	5-17
<i>Figure 5-4: ReScape Principles</i> .....	5-18
<i>Figure 5-5: Beneficial insects can help control pests</i> .....	5-19
<i>Figure 5-6: Detention pond used for hydromodification management</i> .....	5-21
<i>Figure 5-7: This bioretention area treats runoff from an artificial turf field in Berkeley and has an accumulation of crumb rubber particles</i> .....	5-24
<i>Figure 5-8 – Examples of common design problems with inlets of treatment measures</i> .....	5-25
<i>Figure 5-9: A concrete splash apron (with grouted cobble) is placed at the inlet to this stormwater treatment measure in Berkeley to help prevent erosion</i> .....	5-26

<i>Figure 5-10: Another design option is to use vertical elements such as plants or concrete blocks at the inlet to dissipate energy and reduce erosion</i>	5-26
<i>Figure 5-11: This standard curb cut in SF has angled sides, a depressed throat and a 2-inch drop off to a splash apron</i>	5-27
<i>Figure 5-12: Standard curb cut: isometric view</i>	5-27
<i>Figure 5-13: Side wings and concrete aprons prevent blockage and erosion</i>	5-28
<i>Figure 5-14: Standard curb cut with side wings: cut section view</i>	5-28
<i>Figure 5-15: Standard curb cut with side wings: plan view</i>	5-28
<i>Figure 5-16: Stormwater runoff enters the stormwater facility through the 3-foot space between these wheelstops</i>	5-29
<i>Figure 5-17: Opening between wheelstop curbs: section view</i>	5-29
<i>Figure 5-18: Opening between wheelstop curbs: plan view</i>	5-29
<i>Figure 5-19: A grated curb cut allows stormwater to pass under a pedestrian egress zone to the stormwater facility</i>	5-30
<i>Figure 5-20: Grated curb cut: section view</i>	5-30
<i>Figure 5-21: Grated curb cut: plan view</i>	5-30
<i>Figure 5-22: This flow-through planter has a flow spreader pipe to distribute water around the surface and away from the one inlet in the images</i>	5-31
<i>Figure 5-23: Splash block</i>	5-31
<i>Figure 5-24: Slotted Underdrain Pipe Detail</i>	5-33
<i>Figure 5-25: Underdrain Pipe Detail Location with maximized infiltration</i>	5-33
<i>Figure 5-26: Underdrain Pipe Detail Location with no infiltration</i>	5-33
<i>Figure 5-27. London plane tree leaves blocking an inlet</i>	5-35
<i>Figure 6-1: Chapter 6 details and cross-references to the Green Infrastructure Design Guide</i>	6-2
<i>Figure 6-2: Bioretention area</i>	6-5
<i>Figure 6-3: Bioretention areas in a multi-family residential property and in a parking lot</i>	6-6
<i>Figure 6-4: Examples of curb cut inlets at a bioretention area in Burlingame</i>	6-8
<i>Figure 6-5: Bioretention area featuring several plant types</i>	6-9
<i>Figure 6-6: Cross Section, Bioretention Area with Infiltration</i>	6-12
<i>Figure 6-7: Cross Section, Bioretention Area (side view) with Infiltration</i>	6-12
<i>Figure 6-8: Check dam for installing a series of linear bioretention cells in sloped area</i>	6-13
<i>Figure 6-9: Cross section of bioretention area with infiltration showing inlet from pavement</i>	6-13
<i>Figure 6-10: Bioretention area in landscaping to treat runoff from rainwater leaders</i>	6-14
<i>Figure 6-11: Cross section of lined bioretention area, for locations where infiltration is precluded</i>	6-14
<i>Figure 6-12: Flow-through planter (Credit: EOA, Inc)</i>	6-15
<i>Figure 6-13: Flow-through planter with gravel rock mulch (Credit: City of Burlingame)</i>	6-16

<i>Figure 6-14: close-up of flow-through planter with flow spreader (Credit: EOA, Inc)</i> .....	6-18
<i>Figure 6-15: Plan view of long, linear planter, with inlets to the planter distributed along its length at 10' intervals.</i> .....	6-21
<i>Figure 6-16: Plan view of planter designed to disperse flows adequately with only one inlet to planter</i> -6-21	
<i>Figure 6-17: Cross section A-A of flow-through planter, shows side view of underdrain</i> .....	6-22
<i>Figure 6-18: Cross section B-B of flow-through planter, shows cross section of underdrain</i> .....	6-22
<i>Figure 6-19: Tree Well Filter</i> .....	6-23
<i>Figure 6-20: A non-proprietary Tree well filter along a roadway ; and proprietary tree well filters in a parking lot</i> .....	6-24
<i>Figure 6-21: Non-proprietary Tree Filter with curb-cut inlet</i> .....	6-26
<i>Figure 6-22: Cut Away View</i> .....	6-30
<i>Figure 6-23: Schematic of modular suspended pavement system</i> .....	6-30
<i>Figure 6-24: Cross Section Detail of a Tree Well Filter with an integrated trash capture device</i> .....	6-31
<i>Figure 6-25. Cross Section Detail of a tree well filter with suspended pavement system installed under sidewalk</i> .....	6-31
<i>Figure 6-26: Cross Section detail of a tree well filter with Silva Cells under pervious pavement</i> .....	6-32
<i>Figure 6-27: Infiltration Trench</i> .....	6-33
<i>Figure 6-28: Infiltration trench cut-away view</i> .....	6-38
<i>Figure 6-29. Cutaway view: Infiltration Trench with Observation Well</i> .....	6-38
<i>Figure 6-30. Extended Detention Basin</i> .....	6-39
<i>Figure 6-31. Side View of Riser</i> .....	6-44
<i>Figure 6-32: Top View of Riser (Square Design).</i> .....	6-44
<i>Figure 6-33. Plan View, Typical Extended Detention Basin</i> .....	6-45
<i>Figure 6-34. The City of Menlo Park used pervious concrete for parking stalls and standard paving in the drive aisles in this public parking lot</i> .....	6-46
<i>Figure 6-35. Permeable pavers designed for partial infiltration, with underdrain</i> .....	6-53
<i>Figure 6-36. Permeable pavers with detail of underdrain in aggregate trench with upturned elbow.</i> .....	6-53
<i>Figure 6-37. Typical Pervious Concrete Pavement</i> .....	6-54
<i>Figure 6-38. Typical Porous Asphalt Pavement Section</i> .....	6-54
<i>Figure 6-39: Typical Permeable Paver Section</i> .....	6-55
<i>Figure 6-40: Subsurface Check Dam Details.</i> .....	6-55
<i>Figure 6-41: Reinforced grid paving in an overflow parking lot in Napa</i> .....	6-56
<i>Figure 6-42: Concrete Reinforced Grid Paving for Occasional Vehicular Use or for Emergency Access Lanes</i> .....	6-61
<i>Figure 6-43: Plastic Reinforced Grid Paving for Occasional Vehicular Use or for Emergency Access Lanes</i> .....	6-61

<i>Figure 6-44: Parking Lot with Turf-Covered Intensive Green Roof, Google building, Mountain View; and Modular Extensive Green Roof installation, Emeryville.....</i>	<i>6-62</i>
<i>Figure 6-45: Extensive Green Roof at YouTube Headquarters, San Bruno, and Intensive Green Roof, Kaiser Center Parking Garage, Oakland.....</i>	<i>6-63</i>
<i>Figure 6-46: Plants selected to support endangered butterflies on the extensive Green Roof at the California Academy of Sciences, San Francisco. ....</i>	<i>6-64</i>
<i>Figure 6-47: Green roof cross-sections.....</i>	<i>6-66</i>
<i>Figure 6-48: Rainwater is collected and used for flushing toilets at Mills College, Oakland.....</i>	<i>6-67</i>
<i>Figure 6-49: System C Filter Cartridge, Typically Used as Part of Treatment Train.....</i>	<i>6-74</i>
<i>Figure 6-50: Profile View, Typical Cartridge System Filter Array.....</i>	<i>6-78</i>
<i>Figure 6-51: Plan View, Typical Cartridge System Filter Array.....</i>	<i>6-78</i>
<i>Figure 6-52: Photo of subsurface retention/infiltration system installation under a parking lot.....</i>	<i>6-79</i>
<i>Figure 7-1: Stormwater Peak Discharges in Urban and Less Developed Watersheds.....</i>	<i>7-2</i>
<i>Figure 7-2: Effects of Urbanization on the Local Hydrologic Cycle.....</i>	<i>7-3</i>
<i>Figure 7-3. Variation in rainfall contribution to different components of the hydrological cycle for areas with different intensity of urban development.....</i>	<i>7-3</i>
<i>Figure 7-4: In-stream restorative measure using compost socks and vegetation.....</i>	<i>7-5</i>
<i>Figure 7-5: Schematic flow duration pond and flow duration curves matched by varying discharge rates according to detained volume.....</i>	<i>7-9</i>
<i>Figure 8-1: Chapter 8 and Appendix G details and cross-references to the GI Design Guide.....</i>	<i>8-2</i>
<i>Figure 8-2: The 8 Principles of Regenerative Landscaping.....</i>	<i>8-11</i>
<i>Figure 8-3: Protect pollinators and water quality with IPM.....</i>	<i>8-13</i>
<i>Figure 8-4: Bioretention Area in Daly City.....</i>	<i>8-16</i>
<i>Figure 8-5: Flow through planter in Emeryville.....</i>	<i>8-18</i>
<i>Figure 8-6: Tree well filter.....</i>	<i>8-19</i>
<i>Figure 8-7: Infiltration Trench.....</i>	<i>8-20</i>
<i>Figure 8-8: Extended Detention Basin, Palo Alto.....</i>	<i>8-21</i>
<i>Figure 8-9: Permeable pavers in Berkeley.....</i>	<i>8-22</i>
<i>Figure 8-10: Rainwater Harvesting Cistern in Oakland at Mills College.....</i>	<i>8-24</i>
<i>Figure 8-11: Example of a media filter cartridge.....</i>	<i>8-25</i>
<i>Figure 9-1: Before: Vehicle parking and high-water-using turf landscape strip with failing trees on east side of street. ....</i>	<i>9-8</i>
<i>Figure 9-2: After: Parking moved to the west side of the street and the landscape strip widened into a Bay-Friendly bioretention area with trees.....</i>	<i>9-8</i>
<i>Figure 9-3: Map of residential blocks and tributary area of treatment system with new treatment area shown on left side of map in the black outlined strip.....</i>	<i>9-8</i>
<i>Figure C-1: BMP Design Criteria Regions for San Mateo County.....</i>	<i>C-2</i>

*Figure C-2: San Mateo County Mean Annual Precipitation ..... C-3*  
*Figure I-1: Map of Saturated Hydraulic Conductivity (Ksat) and Precipitation Polygons ..... I-10*  
*Figure I 2-4: Percent Capture Achieved by BMP Storage Volume for Various Drawdown Times ..... I-14*

# Glossary of Terms

<p><b>Base Course</b></p>	<p>A layer of constructed material (typically aggregate base – a construction aggregate typically composed of crushed rock or of recycled asphalt or concrete, capable of passing through a sieve with a certain pore diameter) located above the subbase course and/or subgrade course, and below the surface layer (which consists of a wearing course, and sometimes an extra binder course), applied to serve one or more functions, such as supporting the surface layer and distributing load.</p>
<p><b>Bay Area Hydrology Model (BAHM)</b></p>	<p>A computer software application to assist project applicants in sizing specialized detention facilities that will allow a project to meet the Flow Duration Control standard where required by the Hydromodification Management Provision (Provision C.3.g) of the Municipal Regional Stormwater Permit. The BAHM is available for download at: <a href="https://www.clearcreeksolutions.info/downloads">https://www.clearcreeksolutions.info/downloads</a>.</p>
<p><b>Bay Area Stormwater Management Agencies Association (BASMAA)</b></p>	<p>A former consortium of nine San Francisco Bay Area municipal stormwater programs collaborating on stormwater management in the region from 1990-2021. See BAMSC below. <a href="http://www.basmaa.org">www.basmaa.org</a>.</p>
<p><b>Bay Area Municipal Stormwater Collaborative (BAMSC)</b></p>	<p>The Bay Area Municipal Stormwater Collaborative (BAMSC) is an informal association of 103 stormwater management agencies in the San Francisco Bay Area. BAMSC was organized in 2021 by the Board of Directors for BASMAA to continue the information sharing and permittee advocacy functions of BASMAA in an informal manner after BASMAA’s dissolution. BAMSC continues BASMAA’s mission to encourage information sharing and cooperation, and to develop products and programs that are more cost-effectively completed regionally than locally. BAMSC products, along with past BASMAA documents, are available on <a href="http://www.basmaa.org">www.basmaa.org</a>.</p>
<p><b>Bay-Friendly (ReScape) Landscaping</b></p>	<p>A holistic approach to landscaping that works in harmony with the natural conditions of the San Francisco Bay Watershed. Bay-Friendly (ReScape) practices foster soil health and protect water resources while reducing waste and preventing pollution. ReScape has expanded and revised the Bay-Friendly principles into eight Regenerative Landscaping Principles. These can be found on the ReScape website at: <a href="https://rescapeca.org/about-us/principles/">https://rescapeca.org/about-us/principles/</a></p>
<p><b>Rescape (Bay-Friendly Landscaping Coalition)</b></p>	<p>ReScape, previously known as the Bay-Friendly Landscaping Coalition, is a non-profit organization that works in partnership with public agencies, the landscape industry, and property owners to reduce waste and pollution, conserve natural resources, and create vibrant landscapes and gardens around the State of California. <a href="http://www.rescapeca.org">www.rescapeca.org</a></p>

<b>Beneficial Use</b>	A waterbody's beneficial uses are the resources, services, and qualities of aquatic systems that are the ultimate goals of protecting and achieving high water quality. The beneficial uses of surface waters, ground waters, marshes, and mudflats are legally defined in the San Francisco Bay Basin Water Quality Control Basin Plan and serve as a basis for establishing water quality objectives and the discharge prohibitions or conditions necessary to attain them.
<b>Best Management Practice (BMP)</b>	Any program, technology, process, siting criteria, operational method or measure, or engineered system, which when implemented prevents, controls, removes, or reduces pollution. Includes schedules of activities, prohibitions of practices, maintenance procedures, and other management practices to prevent or reduce water pollution. BMPs also include treatment requirements, operating procedures, and practices to control site runoff, spillage or leaks, litter or waste disposal, or drainage from raw material storage. (See Stormwater Control Measures)
<b>Bioinfiltration Area</b>	A type of bio treatment measure designed to maximize infiltration of stormwater, with the remaining design flow or volume of runoff being evapotranspired or filtered and released back to the storm drain system. The difference between a bioinfiltration area and a bioretention area is that the bioinfiltration area is never lined with an impermeable layer; whereas, a bioretention area may be lined or unlined.
<b>Bioretention Area</b>	A type of biotreatment measure designed to treat stormwater with evapotranspiration, some or no infiltration, and the remaining design flow or volume of runoff filtered and released back into the storm drain system. The difference between a bioinfiltration area and a bioretention area is that the bioinfiltration area is never lined with an impermeable layer; whereas, a bioretention area may be lined or unlined.
<b>Biotreatment</b>	A type of low impact development treatment allowed under Provision C.3.c of the MRP. As required by Provision C.3.c.i(2)(vi), biotreatment systems must be designed to have a surface area no smaller than what is required to accommodate a 5 inches/hour stormwater runoff surface loading rate and use biotreatment soil media as specified by BASMAA and in the MRP (Appendix K of this Guide).
<b>Biotreatment Soil Media (BSM)</b>	An engineered soil media meeting the requirements detailed in the BASMAA Biotreatment Soil Media specification as required by the MRP. The current specification (2016) is provided in Appendix K of this Guide.



<p><b>Bituminous Surface Treatment</b></p>	<p>A thin protective wearing surface, which can provide, among other services, a waterproof layer to protect underlying pavement and a filler for existing cracks or raveled surfaces. This includes, but is not limited to:</p> <ul style="list-style-type: none"> <li>• Chip seal – a single layer of asphalt emulsion binder that is covered by embedded aggregate;</li> <li>• Slurry seal – a thick, cold mix paving treatment that contains aggregates, asphalt emulsion, binder and fines, water, and additives;</li> <li>• Seal coat – an emulsion containing liquid asphalt and/or coal tar, mineral fillers and other anti-oxidation additives and admixtures; and</li> <li>• Cape seal – a chip seal covered with a slurry or micro-surface, applied to existing pavements. Micro-surfacing is a polymer-modified cold-mix paving system that begins as a mixture of dense-graded aggregate, asphalt emulsion, water and mineral fillers.</li> </ul>
<p><b>C.3</b></p>	<p>The provision of the Municipal Regional Stormwater NPDES Permit (MRP) that requires each Permittee to control the flow of stormwater and stormwater pollutants from land development projects (i.e., C.3 Regulated Projects or Regulated Projects). Provision C.3 also requires municipalities to implement Green Infrastructure (GI) Plans and various other GI-related actions/projects. For more information on Green Infrastructure, see the <a href="#">Green Infrastructure Design Guide</a> of the GreenSuite.</p>
<p><b>C.3 Regulated Projects (Regulated Projects)</b></p>	<p>Development projects subject to stormwater control requirements as defined by Provision C.3.b.ii of the MRP. This includes public and private projects that create and/or replace quantities of impervious surface above specific thresholds defined in the MRP.</p>
<p><b>C.3.d Amount of Runoff</b></p>	<p>The amount of stormwater runoff from C.3 Regulated Projects that must receive stormwater treatment, as described by hydraulic sizing criteria in Provision C.3.d of the MRP.</p>
<p><b>California Association of Stormwater Quality Agencies (CASQA)</b></p>	<p>Publisher of the California Stormwater Best Management Practices Handbooks, available at <a href="http://www.casqa.org/resources">www.casqa.org/resources</a>.</p>
<p><b>Caltrans</b></p>	<p>The California Department of Transportation, publisher of the Caltrans Standards Specifications Manual.</p>
<p><b>Class 2 Permeable Material (Class 2 Perm)</b></p>	<p>Class 2 Permeable Material is a Caltrans specification for a mix of rock and fines that is placed around underdrains, provides storage in biotreatment measures, and does not require filter fabric, unlike open-graded aggregate.</p>
<p><b>Clean Water Act (CWA)</b></p>	<p>The Federal Water Pollution Prevention and Control Act, or Clean Water Act (33 U.S. Code 1251 <i>et seq.</i>) is intended to control or eliminate surface water pollution and establishes the National Pollutant Discharge Elimination System of permits to regulate surface water discharges from municipal storm drains, publicly-owned treatment works, industrial discharges, and construction sites (&gt; 1 acre).</p>

<b>Cistern</b>	A storage facility that is used to harvest (collect) and store rainwater and/or stormwater for subsequent use. Cisterns can be located above or below ground. Water stored in this way can be used to supplement or replace potable water for irrigation, toilet flushing, or other uses.
<b>City/County Association of Governments (C/CAG)</b>	The City/County Association of Governments of San Mateo County (C/CAG) is a joint powers agency whose members are the County of San Mateo and the 20 incorporated cities and towns within the County. C/CAG administers the San Mateo Countywide Water Pollution Prevention Program (SMCWPPP or “Countywide Program”).
<b>Cobbles</b>	Natural stones of various sizes generally consisting of larger granular material ranging from 3 inches to 24 inches diameter set on soil or set in concrete.
<b>Complete Application</b>	Applications that have been accepted by the Planning Department and have not received a letter within 30 calendar days stating that the application is incomplete (consistent with the Permit Streamlining Act). Where an application has not been accepted by the Planning Department and the applicant has received a letter within 30 days stating that the application is incomplete, the application will be deemed complete if the additional requested information is submitted to the satisfaction of the Planning Department.
<b>Conditions of Approval (COAs)</b>	Requirements the municipality may adopt for a project in connection with a discretionary action (e.g., adoption of an EIR or negative declaration or issuance of a use permit). COAs may include features to be incorporated into the final plans for the project and may also specify uses, activities, and operational measures that must be observed over the life of the project.
<b>Conduit/Conveyance System/ Culvert</b>	Channels or pipes for collecting and directing the flow of water. Types of conduits and conveyance systems include open channels, covered channels and pipes. Culverts are covered channels or large diameter pipes that allow water to flow under a road, railroad, trail, or similar obstruction.
<b>Constructed Wetland</b>	Constructed detention basins that have a permanent pool of water throughout the year and capacity for temporary additional storage of runoff that is released via an outlet structure. They can be designed so that a temporary inundation zone above the permanent pool provides peak flow attenuation and storage. They differ from wet ponds in that they are typically shallower and have greater vegetation coverage. Constructed wetlands also have water quality benefits: they mimic the functions of natural wetlands and use physical, chemical and biological processes to treat stormwater runoff.
<b>Construction General Permit</b>	A statewide NPDES permit adopted by the State Water Resources Control Board (SWRCB) for the discharge of stormwater associated with construction activity from soil disturbance of one (1) acre or more.
<b>Countywide Program</b>	The San Mateo Countywide Water Pollution Prevention Program (SMCWPPP) managed by C/CAG.
<b>Design Storm</b>	A hypothetical rainstorm defined by rainfall intensities and durations.

<b>Detention</b>	The temporary storage of stormwater runoff in ponds, vaults, within berms, or in depressed areas to allow treatment by sedimentation and metered discharge of runoff at reduced peak flow rates. See “Infiltration” and “Retention”.
<b>Direct Infiltration</b>	Infiltration via methods or devices, such as dry wells or infiltration trenches, designed to bypass unsaturated surface soils in order to transmit runoff directly to subsurface soil. See also “Infiltration Device”.
<b>Directly-Connected Impervious Area (DCIA)</b>	The area covered by a building, impermeable pavement, and/or other impervious surfaces, which drains directly into the storm drain without first flowing across permeable land area (e.g., turf buffers).
<b>Directly Discharging</b>	Outflow from a drainage conveyance system that is composed entirely or predominantly of flows from the subject property, development, subdivision, or industrial facility, and not commingled with flows from adjacent lands.
<b>Discharge</b>	A release or flow of stormwater or other substance from a conveyance system or storage container.
<b>Discharger</b>	Any responsible party or site owner or operator within the MRP Permittees’ jurisdiction whose site discharges stormwater runoff, or a non-stormwater discharge.
<b>Drawdown Time</b>	The time required for a stormwater detention or infiltration BMP to drain and return to the dry-weather condition. For detention BMPs, drawdown time is a function of basin volume and outlet orifice size. For infiltration BMPs, drawdown time is a function of basin volume and infiltration rate.
<b>Dry Weather Flow</b>	Flows that occur during periods without rainfall. In a natural setting, dry weather flows result from precipitation that infiltrates into the soil and slowly moves through the soil to the creek channel. Dry weather flows in storm drains may result from human activities, such as over-irrigation.
<b>Dry Well</b>	Structure placed in an excavation or boring, or excavation filled with open-graded rock, that is designed to collect stormwater and infiltrate into the subsurface soil.
<b>Erosion</b>	The wearing away of land surface by wind or water. Erosion occurs naturally from weather or runoff but can be intensified by land-clearing practices related to farming, residential or industrial development, road building, or timber cutting.
<b>Evapotranspiration</b>	Evaporating water into the air directly or through plant transpiration.
<b>Extended Detention Basin</b>	Constructed basins with drainage outlets that are designed to detain runoff from a water quality design storm for some minimum time (e.g., 48 hours) to allow settling of sediment and pollutants.
<b>Filter Fabric</b>	Geotextile of relatively small mesh or pore size that is used to: (a) allow water to pass through while keeping sediment out (permeable); or (b) prevent both runoff and sediment from passing through (impermeable).
<b>Floor Area Ratio</b>	Floor Area Ratio is defined as the ratio of the total floor area on all floors of all buildings at a project site (except structures, floors, or floor areas dedicated to parking) to the total project site area.

<b>Flow-based Treatment Measures</b>	Stormwater treatment measures that treat pollutants from a moving stream of water through filtration, infiltration, sedimentation, and/or biological processes.
<b>Flow Duration</b>	Either a) the total hours that surface flow from a watershed or drainage area occurs at a specified magnitude based on a long-term time history of rainfall and runoff records, or b) the cumulative percentage of total hours that flows exceed the specified magnitude (as used in the BAHM). The overall distribution of flow durations is then expressed by a histogram or cumulative distribution curve, showing flow durations for equal subdivisions of the full range of flow magnitudes occurring over time.
<b>Flow Duration Control</b>	An approach to mitigate development-caused hydromodification which involves developing continuous simulation models of runoff from both pre-project and post-project site conditions, comparing flow durations for a designated range of flows, and designing specialized detention and discharge structures to reduce excess post-project flow duration for flows in the designated range (See Chapter 7). See also “Hydromodification Management”.
<b>Flow-Through Planter</b>	Structure designed for biotreatment of stormwater by retaining and slowly draining it through biotreatment soil media and returning it to the storm drain system through an underdrain. The planter is typically constructed using a concrete box design.
<b>Grading</b>	The excavation and/or filling of the land surface to a desired shape or elevation.
<b>Green Infrastructure (GI)</b>	Stormwater infrastructure that uses vegetation, soils, and natural processes to manage water and create healthier urban environments. At the scale of a city or county, green infrastructure (or green stormwater infrastructure) refers to the patchwork of natural and landscaped areas that provides habitat, flood control, cleaner air, and cleaner water. At the scale of a neighborhood, street, or site, green infrastructure refers to stormwater management systems that mimic nature by soaking up, storing, and/or improving the quality of water.
<b>Green Infrastructure Design Guide</b>	The <a href="#">Green Infrastructure Design Guide</a> is the companion document to this <b>C.3 Regulated Projects Guide</b> . Together they are referred to as the “GreenSuite” and provide guidance pertaining to green infrastructure and LID for the San Mateo Countywide Water Pollution Prevention Program (SMCWPPP). The <b>Green Infrastructure Design Guide</b> provides guidance on stormwater control measures for public and private projects including roadways, parks and other project locations.
<b>Green Roof/ Roof Garden</b>	Vegetated roof systems that retain and filter stormwater prior to drainage off building rooftops.
<b>Gross Density</b>	Gross density is defined as the total number of residential units divided by the acreage of the entire site area, including land occupied by public rights-of-way, recreational, civic, commercial and other non-residential uses
<b>Groundwater</b>	Subsurface water that occurs in pervious geologic formations that are fully saturated.

<b>Hazardous Waste</b>	By-products of human activities that can pose a substantial or potential hazard to human health or the environment when improperly managed. A hazardous waste possesses at least one of four characteristics (flammable, corrosivity, reactivity, or toxicity), or appears on special EPA lists.
<b>Head</b>	In hydraulics, energy represented as a difference in water elevation. In slow-flowing open systems, the difference in water surface elevation, e.g., between an inlet and outlet.
<b>Heritage Tree</b>	An individual tree of any size or species given the ‘heritage tree’ designation as defined by the municipality’s tree ordinance or other section of the municipal code.
<b>High-Flow Bypass</b>	In stormwater treatment measures, a pipe, outlet, or other structure designed to convey flood flows directly to the storm drain systems without entering the treatment measure.
<b>Hydrodynamic Separator</b>	A commonly used term for mechanical stormwater treatment systems that are designed as flow-through structures with a settling or separation unit to remove sediment and other pollutants that may settle to the bottom of the separation unit.
<b>Hydrograph</b>	Runoff flow rate plotted as a function of time.
<b>Hydromodification</b>	“Hydrograph modification”, or more generally the changes in natural watershed hydrological processes and runoff characteristics caused by urbanization or other land use changes that result in increased stream flows and may cause downstream erosion and sediment transport.
<b>Hydromodification Management</b>	Hydromodification management refers to a set of techniques focused on retaining, detaining, or infiltrating runoff (e.g., see “Flow Duration Control”). Hydromodification management helps prevent erosion problems caused by increased stream flows and sediment transport downstream of a watershed.
<b>Hydrologic Soil Group</b>	Classification of soils by the Natural Resources Conservation Service into A, B, C and D groups according to infiltration capacity.
<b>Imperviousness</b>	A term applied to surfaces (roads, sidewalks, rooftops, and parking lots) that prevent or inhibit rainfall from infiltrating into native soils and groundwater.
<b>Impervious surface</b>	A surface covering or pavement of a developed parcel of land that prevents the land’s natural ability to absorb and infiltrate rainfall/stormwater. Impervious surfaces include, but are not limited to, roof tops; walkways; patios; driveways; parking lots; storage areas; impervious concrete and asphalt; gravel areas not built as pervious pavement systems; and any other continuous watertight pavement or covering. Landscaped soil and pervious pavement systems, including pavers with pervious openings and seams, underlain with pervious soil or pervious storage material, such as an aggregate layer sufficient to hold at least the Provision C.3.d volume of rainfall runoff are not impervious surfaces as long as infiltration into native soil can occur. Open, uncovered retention/detention facilities are not considered impervious surfaces for purposes of determining whether a project is a Regulated Project under Provisions C.3.b and C.3.g. Open, uncovered retention/detention facilities are considered impervious surfaces for purposes of runoff modeling and meeting the Hydromodification standard.

<b>Indirect Infiltration</b>	Infiltration via facilities, such as bioretention areas, that are expressly designed to hold runoff and allow it to flow into surface soils. Runoff may reach groundwater indirectly following filtration by surface soils.
<b>Infiltration</b>	Downward entry of runoff into the soil.
<b>Infiltration Devices</b>	Infiltration facilities that are designed to infiltrate stormwater runoff into the subsurface and, as designed, bypass the natural groundwater protection afforded by surface soil. These devices include dry wells, injection wells and infiltration trenches (includes French drains). For the purposes of this document, these are also referred to as direct infiltration methods.
<b>Infiltration Facilities</b>	A term that refers to both infiltration devices and measures.
<b>Infiltration Measures</b>	Infiltration facilities that are wider than they are deep (e.g., bioinfiltration, infiltration basins and shallow wide infiltration trenches and dry wells). For the purposes of this document, these are also referred to as indirect infiltration methods, which allow the downward entry of stormwater runoff into surface soils. The infiltrated water may either percolate down into subsurface soils, or it may be drained into subsurface pipes.
<b>Infiltration Trench</b>	Long narrow trench filled with permeable material (e.g., gravel), designed to store runoff and infiltrate through the bottom and sides into surface and/or subsurface soils.
<b>Inlet</b>	An entrance into a ditch, storm drain, or waterway.
<b>Interceptor Tree</b>	A site design measure that consists of a tree in the landscape near an impervious surface. Trees perform a variety of functions that reduce runoff volumes and improve water quality. Interceptor trees are no longer permitted as a method of compliance with MRP 3.0 C.3 requirements.
<b>Integrated Pest Management (IPM)</b>	An approach to weed and pest control that aims to avoid/reduce the use of chemicals (i.e., pesticides and herbicides). Instead, IPM utilizes regular monitoring to determine if and when treatments are needed and employs physical, mechanical, cultural, biological, and educational tactics to keep pest numbers low enough to prevent unacceptable damage or annoyance. See “Bay-Friendly Landscaping/Rescape.”
<b>Low Impact Development (LID)</b>	A land planning and engineering design approach with a goal of reducing stormwater runoff and mimicking a site’s predevelopment hydrology by minimizing disturbed areas and impervious cover and then infiltrating, storing, detaining, evapotranspiring, and/or biotreating stormwater runoff close to its source, or onsite.
<b>Low Impact Development (LID) Treatment</b>	Removal of pollutants from stormwater runoff using one or more of the following types of stormwater treatment measures: rainwater harvesting and use, infiltration, evapotranspiration, and biotreatment.
<b>Maintenance Plan</b>	A plan detailing operation and maintenance requirements for stormwater treatment measures and/or structural hydromodification measures incorporated into a project.

<b>Maximum Extent Practicable (MEP)</b>	Standard, established by the 1987 amendments to the Clean Water Act, for the implementation of municipal stormwater pollution prevention programs. The Countywide Program uses a continuous improvement approach, regularly updating its performance standards to achieve MEP.
<b>Media Filter</b>	Two-chambered system that includes a pretreatment settling basin and a filter bed filled with sand or other absorptive filtering media.
<b>Municipal Regional Stormwater Permit (MRP)</b>	The Phase I municipal stormwater NPDES permit under which discharges are permitted from municipal separate storm sewer systems throughout San Mateo County and other NPDES Phase I jurisdictions within the San Francisco Bay Region. The current (MRP 3.0) permit ( <a href="#">Order No. R2-2022-0018</a> ) was adopted on May 22, 2022. More information is available on the Regional Board's <a href="#">website</a> .
<b>New Development</b>	Land disturbing activities, including construction or installation of a building or structure, creation of impervious surfaces; and/or land subdivision, on a previously undeveloped site.
<b>Non-Stormwater Discharge</b>	Any discharge to municipal separate storm drain that is not composed entirely of stormwater. Some types of non-stormwater discharges may be authorized by NPDES permits and others are prohibited.
<b>Notice of Intent (NOI)</b>	A formal notice to State Water Resources Control Board submitted by the owner/developer to obtain coverage under the Construction General NPDES Permit (or other General Permit). The NOI provides information on the owner, location, and type of project, and certifies that the permittee will comply with the conditions of the State General Permit.
<b>NPDES Permit</b>	An authorization, license, or equivalent control document issued by EPA or an approved State agency to implement the requirements of the National Pollutant Discharge Elimination System (NPDES) program. As part of the 1972 Clean Water Act, Congress established the NPDES permitting system to regulate the discharge of pollutants from municipal sanitary sewers and industries. The NPDES program was expanded in 1987 to incorporate permits for stormwater discharges as well. Regional Water Quality Control Boards issue stormwater NPDES Permits to local government agencies in order to regulate discharges of municipal stormwater to waters of the state.
<b>Numeric Sizing Criteria</b>	Sizing requirements for stormwater treatment controls established in Provision C.3.d. of the MRP.
<b>Operation and Maintenance (O&amp;M)</b>	Refers to requirements in the MRP to inspect stormwater treatment and hydromodification management measures and implement preventative and corrective maintenance in perpetuity. See Chapter 8.
<b>Operational Source Control Measures</b>	Low technology, low cost activities, procedures, or management practices designed to prevent pollutants associated with site functions and activities from being discharged with stormwater runoff. Examples include good housekeeping practices, employee training, standard operating practices, regenerative landscaping practices (ReScape), and integrated pest management.

<b>Outfall/ Outlet</b>	The point where stormwater discharges from a pipe, channel, ditch, or other conveyance to a waterway.
<b>Percentile Rainfall Intensity</b>	A method of designing flow-based treatment controls that ranks long-term hourly rainfall intensities and selects the 85 <sup>th</sup> percentile value, and then doubles this value.
<b>Percolation</b>	The movement of water through pores in soil or permeable rock.
<b>Permeability</b>	A property of soil that enables water or air to move through it. Usually expressed in inches/hour or inches/day.
<b>Pervious Concrete</b>	A discontinuous mixture of coarse aggregate, hydraulic cement and other cementitious materials, admixtures, and water; having a surface void content of 15-25% allowing water to pass through.
<b>Pervious Pavement</b>	For the purposes of this document, pervious pavement is defined as, but not limited to, any of the following types of properly designed pavement systems: permeable interlocking concrete pavement (permeable pavers); pervious or permeable concrete unit pavers; reinforced grid paving containing either gravel or turf; modular pre-cast and poured-in-place pervious concrete; porous asphalt; turf block; grasscrete; suspended decking and boardwalks; porous rubber; and clay/concrete bricks and stones set on an aggregate base with aggregate in the joint spaces (not sand). Pervious pavement systems are designed to store and infiltrate rainfall at a rate equal to or greater than the immediately surrounding unpaved, landscaped areas, or store and infiltrate the rainfall runoff volume described in Provision C.3.d of the MRP. Pervious pavement must be able to infiltrate water into the ground (native soil) in order to be considered a pervious surface and qualify as LID.
<b>Pervious Surface</b>	A natural, landscaped, or permeable hardscape that allows surface runoff to infiltrate into underlying soils.
<b>Perviousness</b>	The permeability of a surface that can be penetrated by water to infiltrate into the underlying soils.
<b>Point of Compliance</b>	For design to meet Flow Duration Control requirements for hydromodification management, the point at which pre-project runoff is compared to post-project runoff, usually near the point where runoff leaves the project area.
<b>Pollutant</b>	A substance introduced into the environment that adversely affects or potentially affects the beneficial use of the receiving water.
<b>Porous Asphalt</b>	Open-graded asphalt concrete over an open-graded aggregate base that allows surface runoff to infiltrate into underlying soils. Contains very little fine aggregate (dust or sand) and is comprised almost entirely of stone aggregate and asphalt binder.
<b>Post-Construction Stormwater Control</b>	See Stormwater Control Measures.
<b>Priority Development Area</b>	A Priority Development Area is an existing or planned infill development area formally designated by the Association of Bay Area Government's / Metropolitan Transportation Commission's regional planning program.



<b>Precipitation</b>	Any form of rain or snow.
<b>Provision C.3</b>	A section of the MRP requiring each MRP Permittee to control the flow of stormwater and stormwater pollutants from new and redevelopment sites over which it has jurisdiction.
<b>Rational Method</b>	A method of calculating runoff peak flows based on rainfall intensity, acreage of drainage area and land use characteristics.
<b>Redevelopment Project</b>	A project on a previously developed site that adds, replaces, and/or removes impervious surface on the site.
<b>Regional Water Quality Control Board, San Francisco Bay Area Water Board (RWQCB)</b>	One of nine California Regional Water Quality Control Boards, the Regional Water Board for the San Francisco Bay Region is responsible for implementing pollution control provisions of the Clean Water Act and California Water Code within the area that drains to San Francisco Bay and Pacific Ocean. Also referred to as Water Board.
<b>Retention</b>	The storage of stormwater to prevent it from leaving the development site.
<b>Runoff</b>	Water originating from rainfall and other sources (e.g., sprinkler irrigation) that moves across the land surface into drainage facilities, creeks, streams, springs, seeps, ponds, lakes, wetlands, and shallow groundwater.
<b>San Mateo Countywide Water Pollution Prevention Program (“Countywide Program” or “SMCWPPP”)</b>	The Countywide Program of the City/County Association of Governments (C/CAG) consisting of the 16 San Mateo County cities, 4 San Mateo County towns, the County of San Mateo and the San Mateo County Flood and Sea Level Rise Resiliency District (OneShoreline). All these government agencies are listed as Co-permittees in the MRP adopted by the Regional Water Quality Control Board. The Countywide Program implements common tasks and assists the agencies to implement their local stormwater pollution prevention programs. The Countywide Program’s former name was the San Mateo Countywide Stormwater Pollution Prevention Program (STOPPP).
<b>Sedimentation</b>	The process of depositing soil particles, clays, sands, or other sediments.
<b>Sediments</b>	Soil, sand, and minerals washed from land, roofing material, and pavements into water usually after rain, which accumulate in reservoirs, rivers, and harbors.
<b>Self-Retaining Area</b>	A portion of a development site designed to retain the first one inch of rainfall (by ponding and infiltration and/or evapotranspiration) without producing stormwater runoff, and may receive runoff from adjacent impervious areas. Self-retaining areas may include graded depressions with landscaping or pervious pavement.
<b>Self-Treating Area</b>	A portion of a development site in which infiltration, evapotranspiration and other natural processes remove pollutants from stormwater. Self-treating areas may include conserved natural open areas, areas of landscaping, green roofs and pervious pavement. Self-treating areas treat only the rain falling on them and do not receive stormwater runoff from other areas.

<b>Site Design Measures</b>	Site planning techniques used to conserve natural spaces and/or limit the amount of impervious surface at new and redevelopment projects in order to minimize runoff and the transport of pollutants in runoff.
<b>Source Control Measures</b>	Any schedules of activities, structural devices, prohibitions of practices, maintenance procedures, managerial practices or operational practices that aim to prevent stormwater pollution by reducing the potential for pollution at its source. There are two types: Structural and Operational Source Control Measures.
<b>Special Projects</b>	Certain types of smart growth, high density and affordable housing development projects that are allowed, under Provision C.3.e.ii of the MRP, to receive LID treatment reductions.
<b>Storm Drains</b>	Above and belowground structures for transporting stormwater to creeks or outfalls for flood control purposes.
<b>Storm Event</b>	A rainfall event that produces more than 0.1 inch of precipitation and is separated from the previous storm event by at least 72 hours of dry weather.
<b>Stormwater</b>	Stormwater runoff, snow-melt runoff, surface runoff, and drainage, excluding infiltration and irrigation tailwater.
<b>Stormwater Control Measures (SCM)</b>	Features of a development or redevelopment project, or a routinely conducted activity that is intended to prevent, minimize, treat, and/or remove pollutants in stormwater or to reduce erosive flows during the life of the project. Types of Stormwater Control Measures include: source control measures, site design measures, stormwater treatment measures, and hydromodification management measures (Flow Duration Control measures). Also referred to as “post-construction stormwater controls” or “post-construction stormwater measures.”
<b>Stormwater Pollution Prevention Plan (SWPPP)</b>	A plan describing the temporary best management practices used to prevent erosion and control sediment and other pollutants during construction of a project.
<b>Stormwater Treatment Measures</b>	Engineered systems designed to remove pollutants by gravity settling of particulate pollutants, filtration, biological uptake, media adsorption or any other physical, biological, or chemical process. Sometimes called a treatment control, treatment control measure, or treatment control BMP.
<b>Structural Source Control Measures</b>	Permanent features that are designed and constructed as part of a project to prevent pollutants from coming into contact with stormwater runoff, such as sanitary sewer connections for roofed washing areas, or design features that reduce the need for polluting practices.
<b>Subsurface Infiltration System</b>	A stormwater treatment measure, also known as an infiltration gallery, with underground vaults or pipes that store and infiltrate stormwater. These systems allow infiltration into surrounding soil while preserving the land surface above for parking lots, streets, parks, and playing fields.

<b>Suspended Pavement System</b>	Systems that can provide additional uncompacted soil volume for tree root growth by supporting adjacent pavement areas as well as allowing for “underground” bioretention. The pavement can be suspended using modular units such as the Strata Vault and Silva Cell products, structural soils, or constructed suspension systems such as post and beam vaults with uncompacted soil inside the vaults under pavement.
<b>Treatment</b>	The application of engineered systems that use physical, chemical, or biological processes to remove pollutants. Such processes include, but are not limited to, filtration, gravity separation, media adsorption, biodegradation, biological uptake, and infiltration.
<b>Tree Well Filter</b>	A stormwater treatment measure that has a tree planted in it. Tree well filters may be constructed as individual units or linked together in series with or without suspended pavement systems.
<b>Turf Block</b>	Open celled unit paver filled with soil and planted with turf grass.
<b>Vector Control</b>	Any method to limit or eradicate the carriers of pathogens (e.g., viruses or parasites) related to vector-borne diseases, such as mammals, birds, and insects or other arthropods. For the purposes of this document, vector control refers to mosquito control.
<b>Vegetated Filter Strip</b>	Linear strips of vegetated surfaces that are designed to treat sheet runoff flow from adjacent surfaces.
<b>Vegetated Swale</b>	Open, shallow channels with vegetation covering side slopes and bottom that collect and slowly convey runoff flow to downstream discharge points. Vegetated swales may be used only for conveyance or pretreatment – they are no longer considered stand-alone LID treatment systems in the MRP. See Bioretention Area.
<b>Volume-Based Stormwater Treatment Measures</b>	Stormwater treatment measures that are designed to detain the design volume of stormwater for a certain period and treat primarily through sedimentation and/or infiltration.
<b>WEF Method</b>	A method for determining the design volume for stormwater treatment measures, recommended by the Water Environment Federation (WEF) and American Society of Civil Engineers. Described in <i>Urban Runoff Quality Management</i> (WEF/ASCE, 1998).

# Chapter 1: Introduction

## How to Use this Guide

1.1	<i>Purpose of this Guide</i> .....	1-2
1.2	<i>What is the Countywide Program?</i> .....	1-4
1.3	<i>How to Use this Guide</i> .....	1-5
1.4	<i>Precedence</i> .....	1-7

## 1.1 Purpose of this Guide

The **C.3 Regulated Projects Guide** is intended to be a “one-stop shop” for developers, builders, and project managers throughout San Mateo County covering a broad range of design, construction, and maintenance guidance for stormwater control measures in parcel-based regulated projects, in order to meet local municipal requirements and requirements in the Municipal Regional Stormwater Permit (MRP). Municipalities require stormwater control measures as part of their obligations under Provision C.3 of the MRP. The MRP is a National Pollutant Discharge Elimination System (NPDES) permit issued by the San Francisco Bay Regional Water Quality Control Board (Water Board), allowing municipal stormwater systems to discharge to local creeks, San Francisco Bay, and other water bodies.

The San Mateo Countywide Water Pollution Prevention Program (Countywide Program) has developed the GreenSuite of guidance materials consisting of this **C.3 Regulated Projects Guide (this Guide)** and the **Green Infrastructure Design Guide (GI Design Guide)**. This Guide is intended to provide technical information primarily for parcel-based projects (and other regulated projects) that are required to implement stormwater control measures to comply with the MRP. This Guide updates and replaces the Countywide Program’s C.3 Stormwater Technical Guidance (Version 5.0).

The GI Design Guide assists municipalities and project applicants with designing and integrating green infrastructure facilities into street, site, and parking lot projects that may or may not be required to implement stormwater control measures. The GI Design Guide integrates complete street and green street goals (sustainable streets), and aids jurisdictions in the gradual transition of their stormwater infrastructure from “gray” to “green” over time. Both the GI Design Guide and this Guide contain design guidance and typical details for GI and LID implementation in public and private projects. The GI Design Guide updates and replaces the 2009 Sustainable Green Streets and Parking Lots Design Guidebook. The GI Design Guide can be downloaded at [www.flowstobay.org/gidesignguide](http://www.flowstobay.org/gidesignguide).

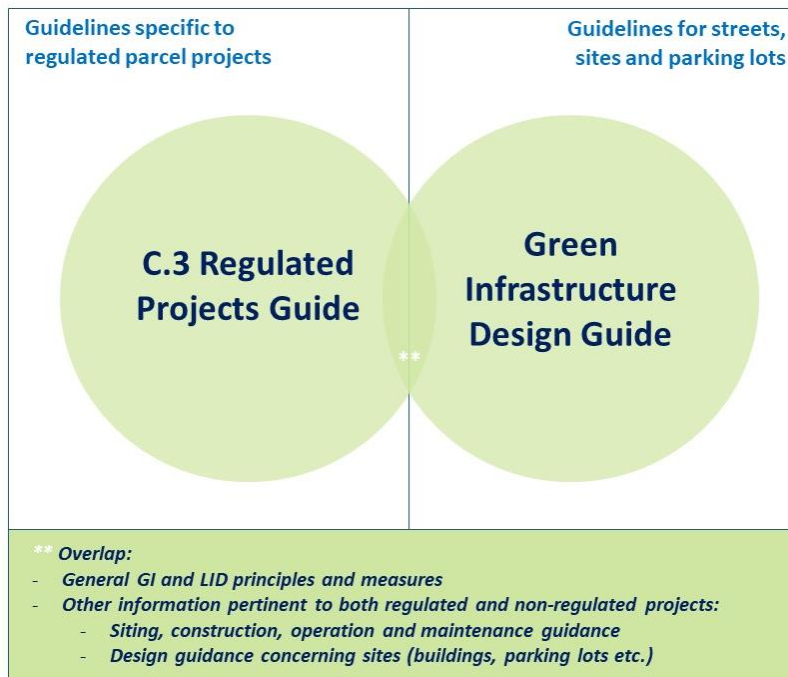


Figure 1-1: The Countywide Program GreenSuite documents – specific and overlapping areas

### Key Point

The term “stormwater control measures” refers to permanent features included in a project to reduce pollutants in stormwater and/or erosive flows during the life of the project – after construction is completed. Stormwater control measures (also known as post-construction stormwater measures) encompass Low Impact Development (LID) strategies, which reduce water quality impacts by preserving and re-creating natural landscape features, minimizing imperviousness, and using stormwater as a resource. See Chapter 2 for more details on terminology.

***This Guide does not provide information on the construction best management practices (BMPs) that protect stormwater quality during construction activities. See the CASQA Construction BMP Handbook for information.<sup>1</sup>***

Stormwater control measures are required for both private and public parcel-based projects. Although this Guide is written primarily for private development project applicants, its technical guidance also applies to publicly-sponsored projects. Municipalities may also find this Guide useful for training municipal staff and contracted staff. This Guide is a “living document” and will be periodically updated to reflect new information, findings, and experience.

---

<sup>1</sup> <https://www.casqa.org/resources/bmp-handbooks>

### *1.2 What is the Countywide Program?*

The City/County Association of Governments of San Mateo County (C/CAG), a joint powers agency whose members are the County of San Mateo, the San Mateo County Flood and Sea Level Rise Resiliency District (OneShoreline), and the 20 incorporated cities and towns, administers the San Mateo Countywide Water Pollution Prevention Program (Countywide Program) to assist San Mateo County Permittees with meeting requirements to reduce pollution in stormwater runoff. These requirements are contained in the San Francisco Bay Regional Water Quality Control Board's (Regional Board) Municipal Regional Permit (MRP) which covers 103 permittees in the Bay Area, including those in San Mateo County.

Each San Mateo County Permittee is individually responsible for implementing the MRP requirements, but participating in the Countywide Program helps Permittees collaborate on countywide initiatives that benefit all members. More information on the Countywide Program is available on its website, at [www.flowstobay.org](http://www.flowstobay.org)

## 1.3 How to Use this Guide

When using this Guide, please keep in mind that **some requirements may vary from one local jurisdiction to the next**. In the very early stages of project planning, contact the municipal planning staff to schedule a pre-application meeting to learn how the C.3 requirements – and other planning, zoning and building requirements – will apply to your project. Also, because regulatory requirements may change, be sure to ask the local municipal staff to provide any updates of information or requirements.

### Key Point

Some requirements described in this Guide **may vary** from one local jurisdiction to the next.

### Remember

It is important to note that design requirements for stormwater control measures are complex and technical. Most projects will require the assistance of a qualified civil engineer, architect, landscape architect, and/or geotechnical engineer.

To help you get started, an overview of the Guide's chapters and appendices follows:

- **Chapter 2** explains how development affects stormwater quality and how stormwater control measures help reduce these impacts, and gives a detailed explanation of *Provision C.3 requirements*.
- **Chapter 3** gives an overview of how the stormwater control management requirements fit into a typical development review process, and offers *step-by-step instructions* on how to incorporate stormwater control/LID designs into planning permit and building permit application submittals for your project.
- **Chapter 4** presents information on *site design measures*, which can help reduce the size of treatment measures.
- **Chapter 5** provides *general technical guidance for stormwater control measures*, including hydraulic sizing criteria, the applicability of non-landscape-based treatment measures, manufactured treatment measures, using “treatment trains,” infiltration guidelines, plant selection and maintenance, mosquito control, and integrating stormwater treatment with hydromodification management.
- **Chapter 6** gives technical guidance for *specific types of stormwater treatment measures*, including bioretention areas, flow-through planters, tree well filters, infiltration trenches, extended detention basins, pervious pavement, green roofs, rainwater harvesting, media filters and subsurface infiltration systems.
- **Chapter 7** explains the requirements for *hydromodification management measures* at certain sites, which keep the flow rates, volumes, and durations of post-construction stormwater flows at pre-construction levels, in order to minimize development-induced erosion in creek channels.
- **Chapter 8** explains the *operation and maintenance* requirements for stormwater treatment measures.



- **Chapter 9** describes the alternative compliance provision of the MRP, which allows projects to contribute to off-site alternative compliance projects instead of constructing on-site stormwater control measures.
- **Appendix A** includes a *list of plants* appropriate for use in LID treatment measures. It also offers general guidance on plant selection and maintenance.
- **Appendix B** presents *example scenarios*, showing how site design, source control and treatment measures can be incorporated into projects and how treatment measures are sized.
- **Appendix C** consists of the *Design Criteria Rainfall Regions and Mean Annual Precipitation* for San Mateo County.
- **Appendix D** describes manufactured stormwater treatment measures that have *limited applicability* on current projects, including inlet filters, oil/water separators, hydrodynamic separators, and media filters.
- **Appendix E** presents guidelines for using stormwater control measures that promote on-site *infiltration* of stormwater.
- **Appendix F** provides guidance for *controlling mosquito production* in stormwater control measures.
- **Appendix G** includes templates for preparing stormwater control measure *maintenance plans*.
- **Appendix H** presents the *Hydromodification Management Applicability Maps*, countywide and by jurisdiction.
- **Appendix I** includes information on the *Feasibility and Sizing of Rainwater Harvesting Systems* and sizing curves for design of these facilities.
- **Appendix J** provides guidance on using the *Special Projects Criteria* approved by the Regional Board to identify infill, high density, and affordable housing projects that may receive LID treatment reduction credits.
- **Appendix K** includes regional *Biotreatment Soil Mix Specifications* approved by the Regional Water Board for use in stormwater biotreatment measures.
- **Appendix L** features *Site Design Requirements for Small Projects*

## *1.4 Precedence*

In case of conflicting information between this Guide and the Municipal Regional Stormwater Permit (MRP), the current version of the MRP shall prevail.

Any local policies, procedures and/or design standards that comply with the MRP also take precedence over the information in this Guide.

# Chapter 2: Background and Regulatory Requirements

<b>2.1</b>	<b><i>Stormwater Problems in Developed Areas</i></b> .....	<b>2-2</b>
2.1.1	Stormwater Runoff in a Natural Setting .....	2-2
2.1.2	Stormwater Runoff in Urban or Urbanizing Areas.....	2-3
<b>2.2</b>	<b><i>Low Impact Development Stormwater Control Measures</i></b> .....	<b>2-4</b>
2.2.1	Terminology .....	2-4
2.2.2	Site Design Measures .....	2-5
2.2.3	Source Control Measures .....	2-5
2.2.4	Stormwater Treatment Measures .....	2-5
2.2.5	Hydromodification Management Measures .....	2-6
<b>2.3</b>	<b><i>Municipal Stormwater Permit (MRP) Requirements</i></b> .....	<b>2-6</b>
2.3.1	Which Projects are Subject to Provision C.3?.....	2-7
2.3.2	What is Required by Provision C.3?.....	2-13
2.3.3	Site Design Requirements for Small Projects.....	2-15
2.3.4	Regulatory Authority .....	2-16

## 2.1 Stormwater Problems in Developed Areas

Throughout the country, stormwater runoff is a leading source of pollutants for water bodies that fail to meet water quality standards<sup>2</sup>. In the San Francisco Bay watershed, urban and agricultural runoff is generally considered to be the **largest source of pollutants** to aquatic systems<sup>3</sup>. Although stormwater runoff is part of the natural hydrologic cycle, human activities can alter the natural drainage patterns, introduce pollutants and increase erosion, degrading the natural habitats.

### 2.1.1 Stormwater Runoff in a Natural Setting

The natural water cycle circulates the earth's water from sky, to land, to sea, to sky in a never-ending cycle. In a pristine setting, soil is covered with a complex matrix of mulch, roots and pores that absorb rainwater. As **rainwater infiltrates slowly into the soil**, natural biologic processes remove impurities. Because most rainstorms are not large enough to fully saturate the soil, only a small percentage of annual rainwater flows over the surface as runoff. Natural vegetation tends to slow the runoff in a meandering fashion, allowing suspended particles and sediments to settle. In the natural condition, the hydrologic cycle creates a stable supply of groundwater, and surface waters are naturally cleansed of impurities. Sediment is carried with the flow of stormwater runoff, but creeks typically find an equilibrium in which sediment is carried without impairing beneficial uses.

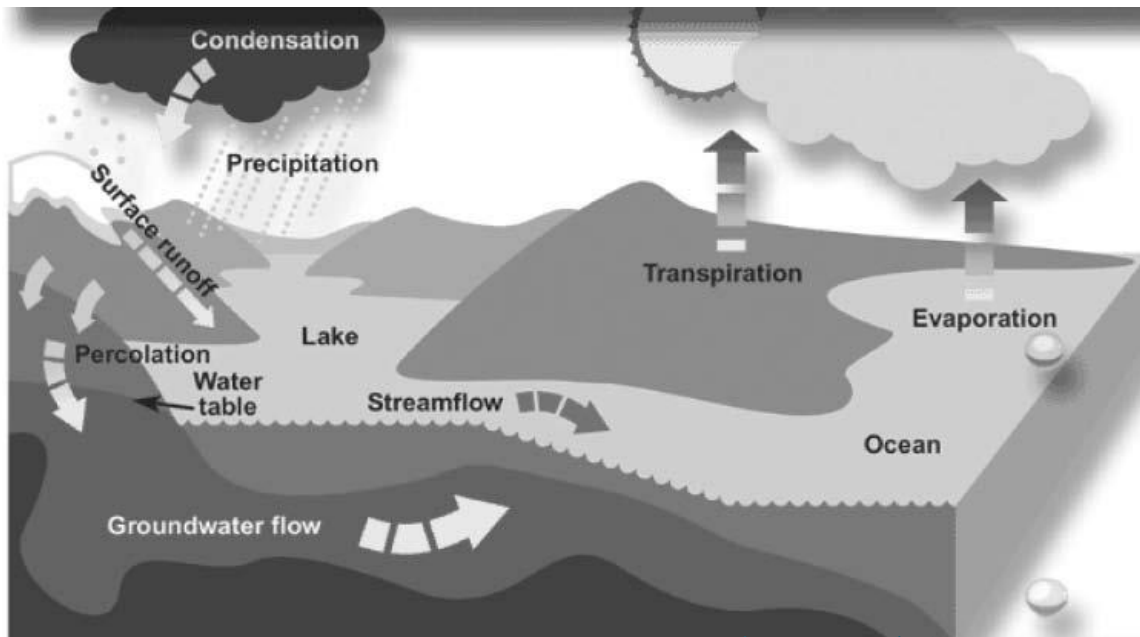


Figure 2-1: The Water Cycle (Source: NGRDC/GDNR, 2005/06)

<sup>2</sup> USEPA, [www.epa.gov/nps/basic-information-about-nonpoint-source-nps-pollution](http://www.epa.gov/nps/basic-information-about-nonpoint-source-nps-pollution)

<sup>3</sup> San Francisco Bay Regional Water Quality Control Board, Basin Plan, 2004, [https://www.waterboards.ca.gov/sanfranciscobay/basin\\_planning.html](https://www.waterboards.ca.gov/sanfranciscobay/basin_planning.html)

### 2.1.2 Stormwater Runoff in Urban or Urbanizing Areas

In developed areas, impervious surfaces – such as roads, parking lots and rooftops – prevent water from infiltrating into the soil. **Most of the rainfall runoff flows across the surface**, where it washes sediment, litter, vehicle fluids, chemicals, and other pollutants into the local storm drain systems. Figure 2-2 contrasts the percentage of rainfall that becomes stormwater runoff in a natural and an urban setting.

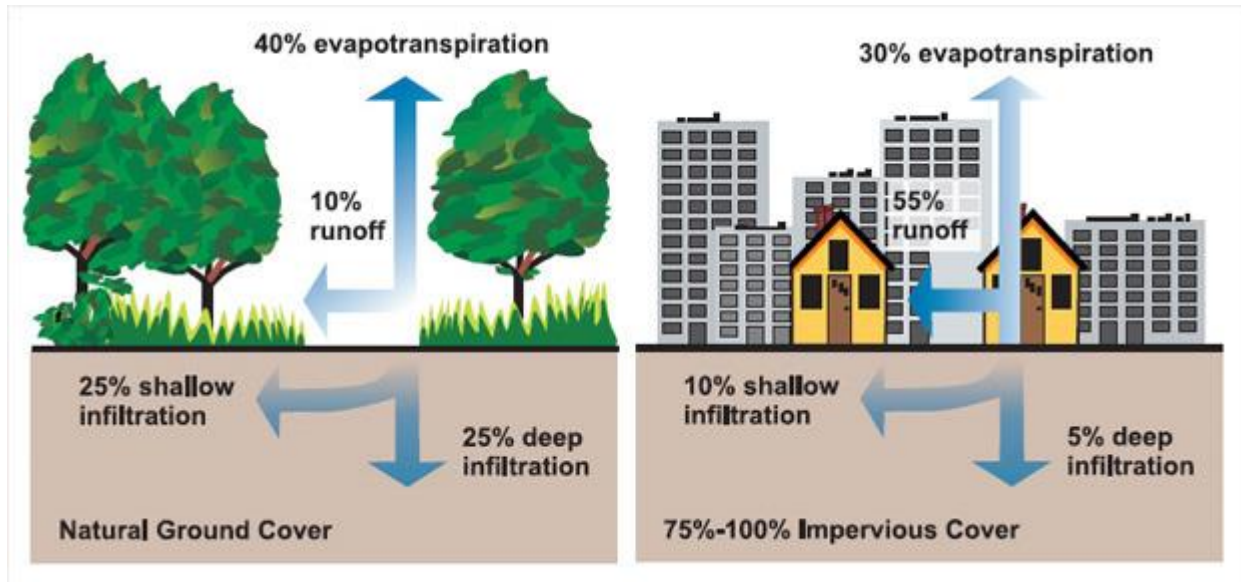


Figure 2-2: Change in volume of stormwater runoff after development (Source: USEPA, 2003)

Not only does urban stormwater runoff **wash pollutants into local waterways**, but it can also cause natural creek channels to erode. When impervious surfaces are built, rainwater runs off at **faster rates and in larger volumes** than in the natural condition. Natural creek channels must suddenly handle much greater volumes



Figure 2-3: Example of consequences of hydromodification – creek with natural banks (left) and creek impacted by hydromodification (right)

of water traveling at much faster rates, greatly increasing the duration of erosive forces on their bed and banks. In response to these changes, creek channels enlarge by downcutting and widening. This effect is called hydrograph modification or hydromodification. Figure 2-3 contrasts a creek channel in the natural condition and a creek channel impacted by hydromodification.

## 2.2 Low Impact Development Stormwater Control Measures

### 2.2.1 Terminology

Stormwater control measures can be divided into four categories: site design measures, source control measures, stormwater treatment measures, and hydromodification management measures (see Figure 2-4). Each of these categories is described in the sub-sections below.

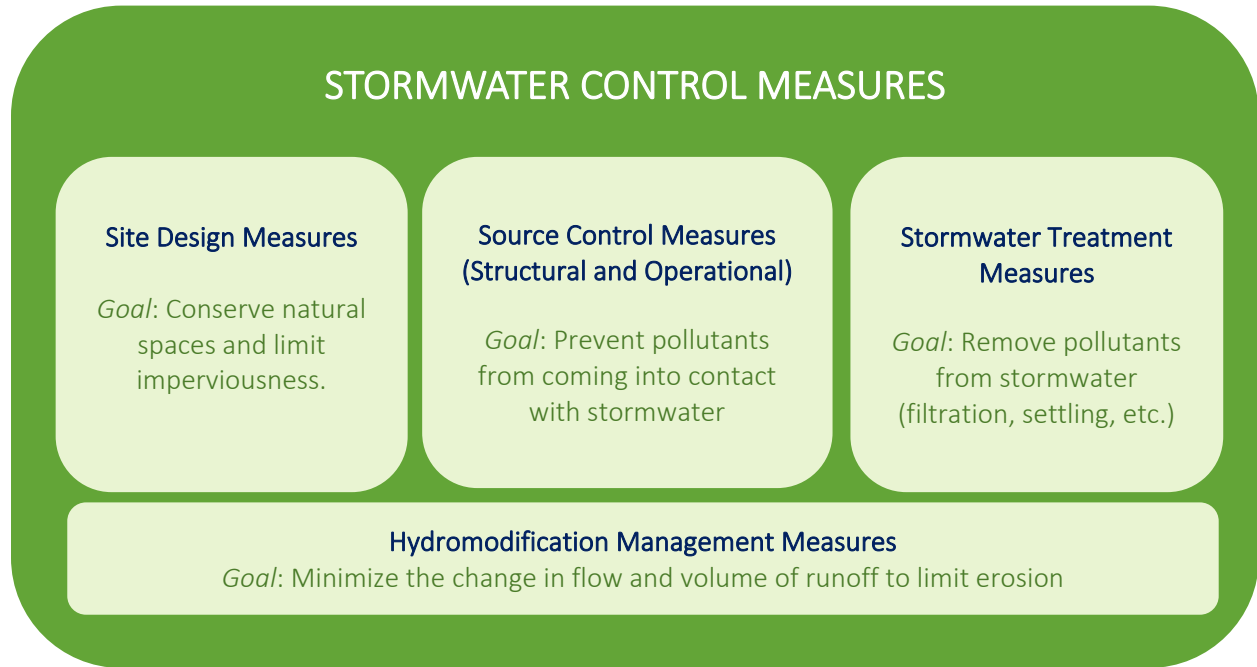


Figure 2-4: The four categories of stormwater control measures

#### Key Point

**Stormwater control measures** have been developed in order to reduce the long-term impacts of development and redevelopment on stormwater quality and creek channels. These stormwater control measures are often called **permanent post-construction stormwater controls** or **low impact development (LID) measures** to distinguish them from the temporary construction best management practices (BMPs) that are identified in a Stormwater Pollution Prevention Plan (SWPPP) and used to control erosion, sediment, and pollutants while a project is being constructed. LID measures reduce water quality impacts of development by preserving and/or re-creating natural landscape features, minimizing imperviousness, and infiltrating, storing, detaining, evaporating, evapotranspiring through plants, and/or biotreating stormwater runoff onsite.

More information on stormwater control measures can be found later in this Guide, as well as in **Chapters 1 and 2 of the GI Design Guide**. A fact sheet is also available on the Countywide Program website.<sup>4</sup>

<sup>4</sup> [https://www.flowstobay.org/wp-content/uploads/2023/04/SMCWPPP-MRP-3.0-C.3-Flyer\\_final.pdf](https://www.flowstobay.org/wp-content/uploads/2023/04/SMCWPPP-MRP-3.0-C.3-Flyer_final.pdf)

### 2.2.2 Site Design Measures

Site design measures are *site planning techniques* for pollution prevention and reduction in flow rates and volumes by protecting existing natural resources and reducing impervious surfaces of development projects. Some examples of site design measures include:

- Minimize land disturbance and preserve high-quality open space;
- Minimize impervious surfaces by using narrow streets, driveways and sidewalks;
- Minimize impervious surfaces that are directly connected to the storm drain system (unless the connection includes a stormwater treatment measure). One example of “disconnecting” impervious surfaces is to direct roof downspouts to splash blocks or “bubble-ups” in landscaped areas;
- Cluster structures and paved surfaces to reduce the total amount of impervious surface; and
- Use sustainable landscape designs, such as those incorporating the eight Bay-Friendly Landscaping principles from ReScape.

### 2.2.3 Source Control Measures

Source control measures consist of either structural project features or operational “good housekeeping” practices that *prevent pollutant discharge and runoff* at the source, such as by keeping pollutants from coming into contact with stormwater.

Examples of structural source controls include:

- Roofed trash enclosures,
- Berms that control run-on to, or runoff from, a potential pollutant source,
- Indoor mat/equipment wash racks that are connected to the sanitary sewer (note that any sanitary sewer connections must be approved by the local permitting authority), and
- Choosing the right plant for the right place, to reduce water consumption and pesticide and fertilizer use.

Examples of operational source controls include:

- Street sweeping,
- Regular inspection and cleaning of storm drain inlets,
- Reducing the use of synthetic fertilizers and pesticides to help create healthy soil and healthy pest-resistant plants, and
- Other landscape and hardscape maintenance practices in **Chapter 6 of the GI Design Guide**.

### 2.2.4 Stormwater Treatment Measures

Effective **December 1, 2011**, the Municipal Regional Stormwater Permit (MRP) requires use of LID measures for stormwater treatment: evapotranspiration, infiltration, rainwater harvesting, or biotreatment. In some

## 2.3 Municipal Stormwater Permit (MRP) Requirements

Special Projects, media filters and high-flow-rate tree well filters are allowed. See Section 2.3.1 for more information on stormwater treatment requirements and Appendix J for information on Special Projects.

Stormwater treatment measures on regulated projects must be sized to comply with one of the hydraulic design criteria listed in MRP Provision C.3.d, which are described in Section 5.1 of this Guide. Chapter 6 provides technical guidance specific to the following, commonly used treatment measures:

- Bioretention areas
- Flow-through planters
- Tree well filters<sup>5</sup>
- Infiltration trenches
- Extended detention basins
- Green roofs
- Pervious pavement
- Rainwater harvesting
- Media filters<sup>6</sup>
- Subsurface infiltration systems

### 2.2.5 Hydromodification Management Measures

Hydromodification management (HM) measures include site design and source control measures that promote infiltration or otherwise *minimize the change in the flow and volume of runoff*, when compared to the pre-development condition. HM measures also include constructed facilities (such as basins, ponds, or vaults) that manage the flow rates and durations of stormwater leaving a site, and under some conditions can also include re-engineering of at-risk channels downstream from the site. In some cases a stormwater treatment measure may be used to meet both the treatment and HM objectives for a project.

## 2.3 Municipal Stormwater Permit (MRP) Requirements

The development or redevelopment of property represents an opportunity to incorporate stormwater control measures that can reduce water quality impacts over the life of the project. The Municipal Regional Stormwater Permit (MRP), reissued by the Water Board in May 2022, includes requirements for incorporating LID measures into new development and redevelopment projects. These requirements are known as Provision C.3 requirements<sup>7</sup>.

---

<sup>5</sup> Effective December 1, 2011, high flow rate tree well filters are allowed only in Special Projects - see Appendix J.

<sup>6</sup> Effective December 1, 2011, media filters are allowed only in Special Projects - see Appendix J.

<sup>7</sup> The text of Provision C.3 and the entire MRP can be found here:

[www.waterboards.ca.gov/sanfranciscobay/water\\_issues/programs/stormwater/MRP/mrp5-22/R2-2022-0018.pdf](http://www.waterboards.ca.gov/sanfranciscobay/water_issues/programs/stormwater/MRP/mrp5-22/R2-2022-0018.pdf)



Provision C.3.b establishes thresholds at which new development and redevelopment projects must comply with Provision C.3, although the MRP also requires agencies to encourage all projects subject to local development review to include adequate source control and site design measures that minimize stormwater pollutant discharges. Regardless of a project's need to comply with Provision C.3, municipalities apply standard **stormwater conditions of approval** for projects that receive development permits. These conditions of approval require appropriate site design, source control measures, and, in some cases, treatment measures.

### Key Point

Regardless of a project's need to comply with Provision C.3, municipalities apply **standard stormwater conditions of approval** to projects that receive development permits.

### 2.3.1 Which Projects are Subject to Provision C.3?

#### Regulated Projects

Thresholds for determining whether Provision C.3 applies to a project (in which case the project is a "Regulated Project") are based on the amount of impervious surface that is created and/or replaced<sup>8</sup> by a project, as described below. Beginning July 1, 2023, the following types of projects are Regulated Projects:

- Private or public projects that create and/or replace **5,000 square feet or more of impervious surface**, including portions of the public right of way, for applicable projects, that are developed or redeveloped as part of the regulated project. These include construction of new roads (and associated bikeways and sidewalks) and widening of existing roads with additional travel lanes.
- Projects involving **reconstruction of existing streets or roads**<sup>9</sup> that create and/or replace **1 contiguous<sup>10</sup> acre or more** of impervious surface and that are public road projects and/or fall under the building and/or planning authority of a Permittee. These include sidewalks and bikeways that are built or rebuilt as part of the existing streets or roads, and utility trenching projects.
- Large detached single-family home projects that create and/or replace **10,000 square feet or more** of impervious surface and are not part of a larger development or redevelopment plan.<sup>11</sup>
- Public projects (e.g., sidewalk gap closures, sidewalk section replacement, and ADA curb ramp installation) creating and/or replacing **5,000 contiguous square feet or more** of impervious surface.
- Pavement maintenance practices associated with parcel-based projects that create and/or replace **5,000 cumulative square feet or more** of impervious surface (e.g., renovation of existing public/private parking lots and other pavement projects), including:

---

<sup>8</sup> Replaced impervious area includes hardscape or roof area installed on an area of a site that was previously impervious, even if the type of impervious surface changes. It also includes the removal and replacement of an asphalt or concrete pavement to base course or lower.

<sup>9</sup> The definition of roads includes roads on levees.

<sup>10</sup> Project areas interrupted by cross streets or intersections are considered contiguous.

<sup>11</sup> The local agency will make the determination if a project is part of a larger plan of development.

## 2.3 Municipal Stormwater Permit (MRP) Requirements

- Removing and replacing an asphalt or concrete pavement to the top of the base course or lower, or repairing the pavement base (including repair of the pavement base in preparation for bituminous surface treatment, such as chip seal), as these are considered replaced impervious surfaces;
- Extending the pavement edge without increasing the size of the road prism, or paving graveled shoulders, as these are considered new impervious surfaces; and
- Resurfacing by upgrading from dirt to gravel, to a bituminous surface treatment (e.g., chip seal), to asphalt, or to concrete; or upgrading from gravel to a bituminous surface treatment, to asphalt, or to concrete, as these are considered new impervious surfaces.

In addition to these thresholds, there are size thresholds for implementing the site design measures - but not stormwater treatment or hydromodification management measures - for the following project types:

- Small projects that create and/or replace between 2,500 and 5,000 square feet of impervious surface; and
- Detached single-family home projects that create and/or replace between 2,500 and 10,000 square feet of impervious surface.

Tables 2-1 and 2-2 provide a summary of Regulated Project types, thresholds, and exclusions.

## 2.3 Municipal Stormwater Permit (MRP) Requirements

Table 2-1: Summary of Regulated Project Types and Thresholds

Project Type/Description	Impervious Surface Threshold Criterion	Impervious Surface Threshold (Square Feet)	Notes	Subprovision
<b>Parcel-Based Requirements</b>				
Detached single-family home not part of a larger plan of development	Cumulative	10,000	1, 2, 3	C.3.b.ii.(6)
Public/private development (e.g., new library on previously undeveloped site)	Cumulative	5,000	1, 3	C.3.b.ii.(1), (2)
Public/private redevelopment project (e.g., renovated hospital, multifamily residential or office building)	Cumulative	5,000	1, 3	C.3.b.ii.(3)
Renovation of existing public/private parking lots and other pavement (see applicable activities in Table 2-2)	Cumulative	5,000	1, 3	C.3.b.ii.(1)
<b>Roads, Sidewalks, and Trails</b>				
New roads, including sidewalks and bike lanes	Contiguous	5,000	1	C.3.b.ii.(4)
Adding traffic lanes to an existing road	Contiguous	5,000	1	C.3.b.ii.(4)
New impervious trail projects ≥ 10 feet wide or creekside (within 50 feet of top of bank)	Contiguous	5,000	1, 4	C.3.b.ii.(4)
Sidewalk gap closures, sidewalk replacement, and ADA curb ramps not associated with a parcel-based project	Contiguous	5,000		C.3.b.ii.(3)
<b>Road Maintenance Projects</b>				
Reconstructing existing roads, including sidewalks and bicycle lanes (see applicable activities in Table 2-2)	Contiguous	1 acre		C.3.b.ii.(5)
Utility trenching projects ≥ 8 feet wide on average over the length of the trench	Contiguous	1 acre		C.3.b.ii.(5)

Notes:

- 1) Projects that fall under the planning and building authority of the Permittee
- 2) Includes addition of an ADU within a lot
- 3) "Project" includes any frontage improvements
- 4) Work may be excluded if runoff is directed to a vegetated area

Table 2-2: Applicability of Pavement Maintenance Activities

Specific Pavement Maintenance Activities	Included or Exempt
Upgrade from dirt to gravel (exempt if built to spec for pervious pavement)	Included
Upgrade from dirt/gravel to asphalt or concrete pavement (exempt if built to spec for pervious pavement)	Included
Removing/replacing asphalt or concrete to top of base course or lower	Included
Repair of pavement base (i.e., base failure repair)	Included
Extending roadway edge (e.g., lane widening or safety improvement)	Included
Paving gravel or dirt roadway shoulder	Included
Interior Remodels	Exempt
Repair of roof or exterior wall surface	Exempt
Pothole and square cut patching	Exempt
Overlay gravel on existing gravel	Exempt
Overlay asphalt or concrete on existing asphalt or concrete (no increase in area)	Exempt
Applying chip seal or cape seal to existing asphalt or concrete pavement (no increase in area)	Exempt
Upgrade from chip seal or cape seal to asphalt or concrete (no increase in area)	Exempt
Shoulder grading	Exempt
Reshaping/regrading drainage	Exempt
Crack sealing	Exempt
Pavement preservation that does not expand road prism	Exempt
Vegetation maintenance	Exempt

### Calculating Impervious Surface

An “impervious surface” is any material that prevents or substantially **reduces infiltration of water into the soil**. This includes building roofs, driveways, patios, parking lots, impervious decking, streets, sidewalks, and any other continuous watertight pavement or covering. Impervious surface is calculated in terms of square feet or acres. When calculating the area of building roofs, be sure to include not only the footprint of the main building or structure, but also any garages, carports, sheds, awnings, roof overhangs, or other miscellaneous structures. Non-building related impervious surfaces include asphalt, concrete, and gravel.

#### Key Point

**Impervious surfaces** are surface coverings or pavement on a developed parcel of land that prevent the land’s natural ability to absorb and infiltrate rainfall/stormwater.

Pervious pavement is not considered an impervious surface, as long as it is underlain with a pervious storage material (such as gravel) that holds at least the Provision C.3.d volume of rainfall runoff and is able to infiltrate water into the ground. Open, uncovered retention/detention facilities are not considered impervious surfaces for purposes of determining whether a project is a regulated project, but they are considered impervious surfaces for purposes of runoff modeling and meeting the Hydromodification standard.

### Key Point

Pervious pavement is not considered impervious, as long as it is underlain with a pervious storage layer that holds at least the Provision C.3.d amount of rainfall runoff and is able to infiltrate water into the ground.

The municipalities in San Mateo County use the “C.3 and C.6 Development Review Checklist”<sup>12</sup> to help applicants with these calculations. *The local jurisdiction should be contacted* for its checklist.

### Exclusions for Pending Projects

All projects that meet the descriptions of Regulated Projects in Provision C.3.b are required to implement LID source control, site design, and stormwater treatment requirements as described in Provisions C.3.c and C.3.d of the MRP. However, Provision C.3.b provides for grandfathering of projects that were approved under a previous municipal stormwater permit, have not yet been constructed, and meet specific criteria described as follows:

- Any regulated project that has been approved with stormwater treatment measures in compliance with Provision C.3.d (numeric sizing criteria) under a previous municipal stormwater permit is exempt from the requirements of Provision C.3.c (LID requirements) in the current MRP and may proceed with the approved treatment measures.
- Any regulated project that was approved with no Provision C.3 stormwater treatment measures under a previous municipal stormwater permit and has not begun construction by July 1, 2023, is required to fully comply with the current requirements of Provisions C.3.c and C.3.d, unless:
  - The project was previously approved with a vesting tentative map that confers a vested right to proceed with development in substantial compliance with the ordinance, policies, and standards in effect at the time the vesting tentative map was approved or conditionally approved, as allowed by State law; or
  - The local agency has no legal authority to require changes to previously granted approvals for the project, e.g., the project has been granted a building permit.
- Any pending regulated project that has not been approved as of June 30, 2023, and for which a Permittee has no legal authority to require new requirements under Government Code sections 66474.2 or 65589.5., subd. (o), is subject to the Provision C.3 requirements in the permit just preceding the current permit (i.e., “MRP 2.0”).

---

<sup>12</sup> <https://www.flowstobay.org/newdevelopment>

### Exclusions for Specific Types of Projects

Provision C.3.b of the MRP excludes specific types of projects from the C.3 requirements for stormwater treatment, source controls and site design measures, even if the thresholds described above are met or exceeded. The list of excluded project types is shown in Table 2-3, below.

*Table 2-3: Projects Excluded from Provision C.3 Requirements*

Category	Excluded Projects
Road and trail projects	<p>Sidewalks built as part of new streets or roads that are constructed to drain to adjacent Self-Retaining areas – see the discussion of Self-Retaining areas in Chapter 4;</p> <p>Bicycle lanes built as part of new streets or roads, but that are not hydraulically connected to the new streets or roads, and that are constructed to direct stormwater runoff to adjacent Self-Retaining areas;</p> <p>Impervious trails built to direct stormwater runoff to adjacent Self-Retaining areas, or other non-erodible permeable areas, preferably away from creeks or toward the outboard side of levees, where those areas are at least half as large as the contributing impervious surface area;</p> <p>Sidewalks, bicycle lanes or trails constructed as pervious pavement systems; and<sup>13</sup></p> <p>Caltrans highway projects and associated facilities<sup>14</sup>.</p>
Remodeling, repair or maintenance projects	<p>Interior remodels;</p> <p>Routine maintenance or repair, such as roof or exterior wall surface replacement, or</p> <p>The following pavement maintenance practices:</p> <ul style="list-style-type: none"> <li>▪ Pothole and square cut patching;</li> <li>▪ Overlaying existing asphalt or concrete pavement with asphalt or concrete without expanding the area of coverage;</li> <li>▪ Shoulder grading;</li> <li>▪ Reshaping/regrading drainage systems;</li> <li>▪ Crack sealing;</li> </ul>

<sup>13</sup> As defined in the Glossary

<sup>14</sup> Caltrans has its own statewide stormwater NPDES permit, but when a Caltrans project is located in the right-of-way of a municipality covered by the MRP, the project must comply with C.3 requirements.

Category	Excluded Projects
	<ul style="list-style-type: none"> <li>▪ Pavement preservation activities that do not expand the road prism;</li> <li>▪ Upgrading from a bituminous surface treatment (e.g., chip seal) with an overlay of asphalt or concrete, without expanding the area of coverage;</li> <li>▪ Applying a bituminous surface treatment to existing asphalt or concrete pavement, without expanding the area of coverage;</li> <li>▪ Vegetation maintenance; and layering gravel over an existing gravel road, without expanding the area of coverage.</li> </ul>

### 2.3.2 What is Required by Provision C.3?

#### General Requirements for Regulated Projects

Projects that are subject to Provision C.3 (C.3 Regulated Projects) must implement:

- Site design measures;
- Source control measures;
- Low impact development (LID) treatment measures; and
- Hydromodification management measures, if applicable.

#### Special Projects

LID treatment requirements can be reduced for certain smart growth, high density, or affordable housing development projects (“Special Projects”) if a municipality chooses to allow the option. If a project meets the Special Projects criteria provided in Appendix J, specific non-LID treatment measures may be used to treat a percentage of the total C.3.d amount of stormwater runoff that requires treatment. Two types of non-LID treatment measures are allowed in Special Projects: high flow rate tree well filters and high flow rate media filters. See Appendix J for criteria and procedures for identifying Special Projects and calculating the LID treatment reduction.

#### Single-Family Home Projects

Single-family home projects are regulated when the following conditions are applicable:

- The construction of the detached single-family home is a stand-alone project that is not part of a larger, common plan of development. Typically, a larger common plan of development has shared infrastructure, such as utilities, and contiguous parcels, but the final determination will be made by the jurisdiction approving the project.

- The project replaces and/or creates 10,000 square feet or more of impervious surface.

Site design measures can be effectively used to reduce the impervious surfaces created and/or replaced as part of a single-family home project, which may have implications for whether the project requires stormwater treatment control measures under the 10,000 square foot threshold.

### Hydromodification Management Requirements

Projects that meet all of three of the following criteria must incorporate hydromodification management measures: 1) the project creates and/or replaces **one acre or more** of impervious surface; 2) the project is located in an area susceptible to hydromodification (shown in a map in Appendix H); and 3) the amount of post-project impervious surface area is increased above pre-project conditions. See Chapter 7 for more information.

### Redevelopment Projects – 50% Rule

If a project is located on a previously developed site and will result in the **replacement of impervious surface**, then it is considered a redevelopment project and the **“50 Percent Rule”** (as defined below) may apply:

- Redevelopment projects that replace or alter **more than 50 percent** of the existing on-site impervious surface are required to treat stormwater runoff from the entire site consisting of all existing, new, and/or replaced impervious surfaces (as well as any frontage area that is redeveloped).
- Redevelopment projects that replace or alter **less than 50 percent** of existing on-site impervious surface need to treat stormwater runoff only from the new and/or replaced impervious surface of the site (including frontage) that is redeveloped.

### Road Reconstruction Projects

Road reconstruction projects that create and/or replace 1 contiguous<sup>15</sup> acre or more of impervious surface and that are public road projects and/or fall under the building and planning authority of a permittee (including sidewalks and bicycle lanes that are built or rebuilt as part of the existing streets or roads) are required to comply with Provision C.3, including the “50 percent rule” for stormwater treatment (see above).

Additionally, the following road maintenance practices will also be considered Regulated Projects under the Road Reconstruction category, if they trigger the 1 contiguous acre threshold.

- Removing and replacing an asphalt or concrete pavement to the top of the base course<sup>16</sup> or lower, or repairing the pavement base (including repair of the pavement base in

---

<sup>15</sup> “Contiguous” as defined on page C.3-9 of the MRP, “Project areas interrupted by cross streets or intersections are considered contiguous.”

<sup>16</sup> “Base Course” as defined on page C.3-5 of the MRP, “A layer of constructed material (typically aggregate base – a construction aggregate typically composed of crushed rock or of recycled asphalt or concrete, capable of passing through a sieve with a certain pore diameter) located above the subbase course and/or subgrade course, and below the surface layer (which consists of



preparation for bituminous surface treatment, such as chip seal), as these are considered replaced impervious surfaces;

- Extending the pavement edge without increasing the size of the road prism, or paving graveled shoulders, as these are considered new impervious surfaces; and
- Resurfacing by upgrading from dirt to gravel, to a bituminous surface treatment<sup>17</sup> (e.g., chip seal) to asphalt, or to concrete; or upgrading from gravel to a bituminous surface treatment, to asphalt, or to concrete, as these are considered new impervious surfaces.

The Road Reconstruction Project category also includes utility trenching projects which are greater than or equal to 8 feet wide, on average, over the entire length of the project and replace 1 contiguous acre or more of impervious surface.

### Alternative Compliance

The MRP allows projects to use “alternative compliance,” to meet stormwater treatment requirements offsite. See Chapter 9 for more information.

### How Do Projects Meet the C.3 Requirements?

The project’s development permit application submittals must include detailed information showing how the Provision C.3 stormwater requirements will be met.

Chapter 3 provides *step-by-step instructions* for incorporating C.3 stormwater submittals into permit applications.

#### Key Point

See Chapter 3 for *step-by-step instructions* on incorporating C.3 stormwater submittals into permit applications.

### 2.3.3 Site Design Requirements for Small Projects

Certain small projects must meet site design requirements in Provision C.3.i of the MRP. This applies to:

- Projects that create and/or replace between 2,500 and 5,000 square feet of impervious surface; and
- Individual detached single-family home projects that create and/or replace between 2,500 and 10,000 square feet of impervious surface.

Applicable projects must implement at least one of the following site design measures:

- Direct roof runoff into cisterns or rain barrels for use.
- Direct roof runoff onto vegetated areas.
- Direct runoff from sidewalks, walkways, and/or patios onto vegetated areas.

---

a wearing course, and sometimes an extra binder course), applied to serve one or more functions, such as supporting the surface layer and distributing load.”

<sup>17</sup> “Bituminous surface treatment” as defined on page C.3-5 of the MRP, “A thin protective wearing surface, which can provide, among other services, a waterproof layer to protect underlying pavement and a filler for existing cracks or raveled surfaces.” See the Glossary in this Guide for more details.

- Direct runoff from driveways and/or uncovered parking lots onto vegetated areas.
- Construct sidewalks, walkways, and/or patios with pervious pavement.
- Construct bike lanes, driveways, and/or uncovered parking lots with pervious pavement.

Chapter 4 and Appendix L provide guidance to assist in selecting and implementing appropriate site design measures for small projects. Included in Appendix L are four fact sheets that provide detailed information for implementing the six site design measures.

### *2.3.4 Regulatory Authority*

The Countywide Program's municipalities derive their authority to regulate stormwater quality and hydrograph modification impacts primarily from their stormwater ordinances. However, related municipal code sections, GI Plans, other planning documents, resolutions, policies and standard procedures can also be important regulatory mechanisms. Each municipal stormwater ordinance may have unique elements, but they provide municipalities with the authority to implement the MRP, including the requirements of Provision C.3 as described above. Some municipalities may have ordinances or other policies that go above and beyond the requirements in the MRP.

#### Remember

**Violations of a municipal stormwater ordinance** may be subject to civil and/or criminal actions such as:

- Temporary and/or permanent injunction;
- Assessing costs of any inspection to establish the violation and bring legal action;
- Costs incurred in removing, correcting, or terminating adverse effects of the violation;
- Compensatory damages for impairment of water quality, wildlife, fish or aquatic life;
- Order to cease and desist a violation;
- Notice to remove waste or other material that may result in an increase in pollutants entering the stormwater drainage system; and
- Arrest or citation of persons violating the stormwater ordinance.

# Chapter 3: Preparing Permit Application Submittals

<i>3.1 The Development Review Process .....</i>	<i>3-2</i>
<i>3.2 How to Prepare Planning Permit Submittals .....</i>	<i>3-4</i>
3.2.1 The Planning Permit Submittal Checklist .....	3-4
3.2.2 Planning Permit Submittals: Step-by-Step .....	3-6
<i>3.3 How to Prepare Building Permit Submittals .....</i>	<i>3-17</i>
<i>3.4 Simple Instructions for Small Sites Subject to Stormwater Treatment Requirements.....</i>	<i>3-20</i>

### 3.1 The Development Review Process

Municipalities have integrated their review of stormwater control measures into the development review process. If the C.3 requirements for site design measures, source controls, and stormwater treatment measures apply to the project, the planning permit application submittal must show how the required stormwater control measures have been incorporated. Some agencies will require each project to submit a Stormwater Management Plan or Stormwater Control Plan that contains these details, and/or will issue Stormwater Permits in addition to planning and building permits to manage the process and recover costs for stormwater-related plan check and inspection services.

#### Key Point

Preparing the preliminary design of stormwater control measures simultaneously with the preliminary site plan and the landscaping plan can help reduce overall project costs.

Section 3.2 gives step-by-step instructions on how to prepare a planning permit submittal, beginning at the earliest phases of project planning. Some smaller projects may not require planning permits; see Section 3.4 for *simple instructions for small sites*.

Preparing the preliminary design of stormwater control measures simultaneously with the *preliminary site plan* and the landscaping plan is advised to achieve the following benefits:

- Maximize the stormwater benefits of project landscaping;
- Improve site aesthetics and produce a better quality project;
- Speed project review times;
- Avoid unnecessary redesign;
- Reduce overall project costs; and
- Allow for the design team to coordinate project documents among disciplines.

After the municipality issues the planning permit, the required stormwater information will need to be incorporated into the building permit application submittal. Section 3.3 gives step-by-step instructions for preparing this submittal. A simplified diagram of a sample development review process is shown in Figure 3-1. Please note that the actual development review process in any of the municipalities may differ from the example.

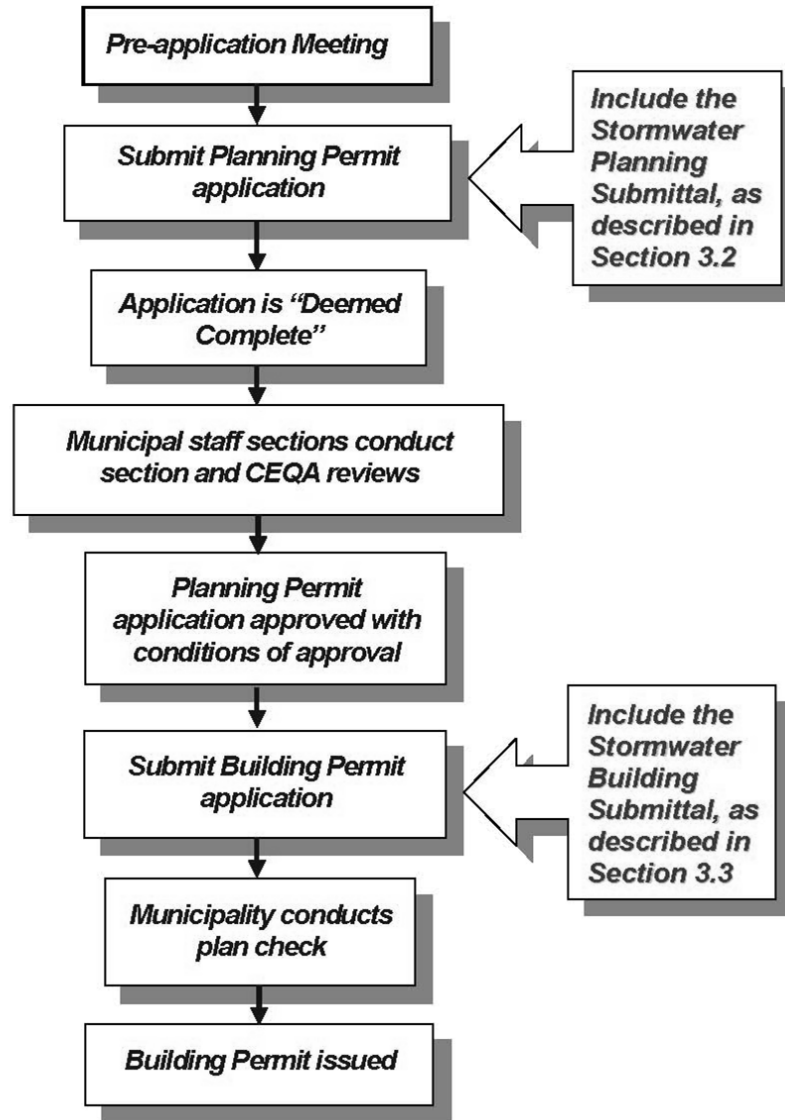


Figure 3-1: Sample Development Review Process for projects subject to Provision C.3 requirements for site design measures, source controls and stormwater treatment measures

Although the development review process may vary from one municipality to the next, Figure 3-1 highlights the steps in the development review process where municipalities typically require submittals showing how the project incorporates stormwater control measures. These submittals are incorporated into the planning permit and building permit applications. Remember that the C.3 submittals show how the project will incorporate stormwater control measures, to reduce pollutant loading and prevent increases in creek channel erosion **during the life of the project**. The municipality will require the preparation of separate documents, such as a SWPPP, to show how erosion and sediment will be controlled **during construction**. Sections 3.2 and 3.3 present step-by-step instructions for preparing C.3 stormwater submittals for planning, building, and/or stormwater permit applications.

## 3.2 How to Prepare Planning Permit Submittals

The Countywide Program has developed two checklists that the municipalities may use to identify the requirements for stormwater control measures that apply to the project at this phase in project development. The **C.3 and C.6 Development Review Checklist** may be used to identify specific requirements regarding the types of site designs, source controls, treatment measures and hydrograph modification measures that should be incorporated in the project. Municipal staff also use this checklist to identify erosion and sediment controls and other best management practices that will be required during construction of the project.

### Key Point

C.3 submittals show how the project will reduce pollutant loading and prevent increases in creek channel erosion during long-term project **operations**. Separate documents will need to be prepared to show how sedimentation and erosion will be controlled **during construction**.

The **Planning Permit Submittal Checklist** is provided below to help identify the C.3 stormwater-related items that will need to be submitted with the planning permit application. Please note that it's important to **contact the planning staff of the local jurisdiction** to discuss the specific requirements that may apply to the project. After obtaining a complete list of submittal requirements, the Step-by-Step instructions in this section may be used to prepare the submittal. Applicants with smaller Regulated Projects are encouraged to read Section 3.4, "**Simple Instructions for Small Sites**," before using the Step-by-Step instructions.

### 3.2.1 The Planning Permit Submittal Checklist

Table 3-1 presents a checklist of the stormwater control measure information that is typically submitted with planning permit applications. Please note that if runoff from the site discharges directly to a creek or wetland without flowing through a municipally-owned storm drain, additional information may need to be submitted. Municipal staff may use this checklist to determine whether the submittal is complete, or some jurisdictions may use a modified checklist. The items included in this checklist are important to demonstrate that the project will:

- Incorporate **site design measures** to reduce impervious surfaces, promote infiltration and reduce water quality impacts;
- Apply **source control measures** to keep pollutants out of stormwater runoff;
- Use stormwater **treatment measures** to remove pollutants from stormwater; and
- Where applicable, manage **hydromodification** (erosion-inducing flows) by reducing the rate and amount of runoff.

Table 3-1: Planning Permit Submittal Checklist

Required? <sup>1</sup>		Information on Project Drawings	Corresponding Planning Step (Section 3.2.2)
Yes	No		
<input type="checkbox"/>	<input type="checkbox"/>	Existing natural hydrologic features (depressions, watercourses, relatively undisturbed areas) and significant natural resources.	Step 1
<input type="checkbox"/>	<input type="checkbox"/>	Soil types and depth to groundwater.	Step 1
<input type="checkbox"/>	<input type="checkbox"/>	Existing and proposed <u>site</u> drainage network and connections to drainage offsite. Existing and proposed <u>off-site</u> drainage network, if needed.	Step 1
<input type="checkbox"/>	<input type="checkbox"/>	For more complex drainage networks, show separate drainage areas in the existing and proposed site drainage network.	Step 1
<input type="checkbox"/>	<input type="checkbox"/>	Existing condition, including pervious and impervious areas, for each drainage area.	Step 1
<input type="checkbox"/>	<input type="checkbox"/>	Proposed pervious surfaces, including sensitive natural areas to be preserved and protected from development (for each drainage area).	Steps 2 and 3
<input type="checkbox"/>	<input type="checkbox"/>	Proposed site design measures to minimize impervious surfaces and promote infiltration <sup>2</sup> , which will affect the size of treatment measures.	Steps 3 and 4
<input type="checkbox"/>	<input type="checkbox"/>	Proposed impervious surfaces, e.g., roof, plaza, sidewalk, street, parking lot (for each drainage area).	Step 4
<input type="checkbox"/>	<input type="checkbox"/>	Proposed locations and approximate sizes of stormwater treatment measures if the project is a regulated project (see Step 5 for determination). Elevations should show sufficient hydraulic head for the treatment measures to work. <sup>2</sup>	Steps 5 - 9
<input type="checkbox"/>	<input type="checkbox"/>	Proposed locations, types and approximate sizes of hydromodification management measures, if the project is required to provide them.	Steps 7-9
<input type="checkbox"/>	<input type="checkbox"/>	Conceptual planting palette for stormwater treatment measures. <sup>2</sup>	Step 10
<input type="checkbox"/>	<input type="checkbox"/>	Pollutant source areas – including loading docks; food service areas; refuse areas; outdoor processes and storage; vehicle cleaning, repair or maintenance; fuel dispensing; equipment washing; etc. – and corresponding source controls from the local source control list.	Step 12
<b>Written Information on Municipal Forms or in Report Format</b>			
<input type="checkbox"/>	<input type="checkbox"/>	Completed “C.3 and C.6 Development Review Checklist” (obtain from municipality).	Step 4
<input type="checkbox"/>	<input type="checkbox"/>	Preliminary calculations for each treatment or hydromodification management measure and narrative of treatment approach.	Step 9
<input type="checkbox"/>	<input type="checkbox"/>	Preliminary maintenance plan for stormwater treatment measures.	Step 11
<input type="checkbox"/>	<input type="checkbox"/>	List of source control measures included in the project.	Step 12
<p><sup>1</sup> Every item is not necessarily required for a project. Municipal staff may check the boxes in the “Required” column to indicate items required for a project.</p> <p><sup>2</sup> Site design and treatment measures that promote stormwater infiltration should be consistent with recommendations of the project geotechnical engineer based on the soils boring data, drainage pattern and the current requirements for stormwater controls.</p>			

### 3.2.2 Planning Permit Submittals: Step-by-Step

Step-by-step instructions are offered below to help incorporate stormwater control measures into the project from the very beginning of permit planning. The step-by-step instructions are intended to help **prepare the necessary materials** to submit along with the planning permit application.

#### Planning Permit Submittal - Step 1: Collect Needed Information

Collecting the appropriate information is essential to selecting and siting post-construction stormwater measures. A list of the most **commonly needed information** is provided below, but municipal staff may request additional information and may require applicants to fill out and submit the “C.3 and C.6 Development Review Checklist.”

- **Introductory narrative** of the stormwater management plan and summary of the site/project.
- Determine the **site boundaries** and the **off-site improvements** that may be required for the frontage area. The MRP requires that any impervious surfaces created or replaced as part of the project, including areas in the frontage of the site in the public right of way, be managed by stormwater control measures. These areas can include sidewalks, roadways, planter strips, cycling facilities, street trees, etc. Discuss the options and typical/standard details for stormwater control measures in the public right of way with the local jurisdiction.
- Existing natural features and landscaping (including on-site trees and street trees in the frontage area), especially **hydrologic features** including creeks, wetlands, watercourses, seeps, springs, ponds, lakes, areas of 100-year floodplain, and any contiguous natural areas. This information may be obtained by site inspections, a topographic survey of the site, and existing maps such as US Geologic Survey (USGS) quadrangle maps, Federal Emergency Management Agency (FEMA) floodplain maps, US Fish and Wildlife Service (USFWS) wetland inventory maps, and the Oakland Museum of California Creek & Watershed Maps ([www.museumca.org/creeks](http://www.museumca.org/creeks)).
- Existing site and off-site (frontage area) **topography**, including the general direction of surface drainage, local high or low points or depressions, any steep slopes, outcrops, or other significant geologic features. This may be obtained from topographic maps and site inspections.
- Existing site and off-site (frontage area) **drainage**. For undeveloped sites, this would be identified based on the topographic information described above. For previously developed sites, information on drainage and storm drain connections may be obtained from municipal storm drain maps, plans for previous development, and site inspections.
- **Soil types** (including hydrologic soil groups) and **depth to groundwater**. If a soils report is not required for the project, planning-level information may be obtained from the Natural Resources Conservation Service (NRCS) Web Soil Survey<sup>12</sup>. This information is used in determining the feasibility of onsite infiltration of stormwater. For additional information on soil types, see Appendix E – Infiltration Guidelines.
- **“Retained”, “Replaced” and “Created” impervious surfaces**. The “C.3 and C.6 Development Review Checklist” includes an “Impervious and Pervious Surfaces Table” that summarizes the square

---

<sup>12</sup> <https://websoilsurvey.sc.egov.usda.gov/App/HomePage.htm>



footage of pre-project and post-project impervious and pervious surfaces. As defined in the Checklist, “Retained” means existing impervious surfaces that are left in place unchanged; “Replaced” means new impervious surface that is installed where existing impervious surface is removed anywhere on the same property; and “Created” means the amount of new impervious surface being constructed which exceeds the total existing amount of impervious surface at the property. For example, if a portion of the pre-project impervious parking lot is to be left untouched and used as is on the post-project site, that impervious surface would be considered “Retained”; when a building is constructed in an area that used to be an impervious surface parking lot, the building roof impervious surface has “Replaced” the parking lot impervious surface and is not considered “Created” even though it is a new roof; and finally, if some landscaped area (considered pervious) on the site was paved over for new post-project impervious parking spaces, then that new impervious area would be considered “Created”. The data in the table are required for several calculations including determining whether treatment measures apply to the project.

- **Existing impervious areas.** Measuring the area of existing impervious surface is necessary to calculate the amount of impervious surface that will be replaced. The MRP requires that redevelopment projects that replace 50 percent or more of impervious surface on the whole site treat the stormwater runoff from the whole site - not just the redeveloped area. If less than 50 percent of existing impervious surface is being replaced, then only the area within the scope of the activity for which a permit is currently being applied must be included in treatment measure design.
- **Zoning and planning** information, such as setback, tree, open space, and street requirements.

Review the information collected in Step 1. Identify the principal constraints on site design and stormwater treatment measure selection, as well as opportunities to reduce imperviousness and incorporate stormwater controls into the site and landscape design. For example, **constraints** might include impermeable soils, high groundwater, steep slopes, geotechnical instability, high-intensity land use, heavy vehicular traffic, or safety concerns. **Opportunities** for siting stormwater controls might include existing natural areas, low areas, oddly configured or otherwise unbuildable parcels, landscape amenities including open space and buffers (which can double as locations for stormwater treatment measures) and differences in elevation (which can provide hydraulic head for moving stormwater runoff through treatment measures). Preparing a table or brief written summary of constraints and opportunities can prove helpful in selecting and siting stormwater controls.

### Key Point

**Constraints** for siting stormwater controls may include impermeable soils, high groundwater, steep slopes, or geotechnical instability.

**Opportunities** may include existing natural areas, low areas, or landscaping.

## Planning Permit Submittal - Step 2: Minimize Site Disturbance and Protect Sensitive Areas

Design the site layout to minimize changes to the natural topography. Using information collected in Step 1, identify any existing sensitive natural resources on the site to protect and preserve from development. These may include the following types of areas.

- Development should be set back from **creeks and riparian habitat** as required by the local jurisdiction. If the project involves impacts to creeks and riparian habitat, the approvals may need to be obtained from a number of resource protection agencies, including but not limited to the San Francisco Bay Regional Water Quality Control Board and the California Department of Fish and

Wildlife. Guidance for obtaining these approvals is provided in San Mateo County's *Guide to Creek and Wetland Project Permitting*, at <http://flowstobay.org/files/construction/creekwetland.pdf>.

- If the project includes **wetlands** subject to Section 404 of the federal Clean Water Act, or habitat for **special-status species** protected by federal or State laws, these areas should be indicated, and evidence should be provided to demonstrate compliance with the applicable laws. See the above reference to the *Guide to Creek and Wetland Project Permitting* and the Joint Aquatic Resource Permit Application (JARPA) website at [www.bcdc.ca.gov/forms/forms.html](http://www.bcdc.ca.gov/forms/forms.html).
- The project will need to comply with any local tree preservation ordinances and other policies protecting **heritage or significant trees and street trees**. Mature trees offer substantial stormwater benefits, and their preservation is recommended, where feasible, even if it is not required by law.
- The project needs to comply with any local restrictions on development of **steep slopes** and soils that are susceptible to **erosion**. Even where not required by law, the avoidance of such areas is advisable in order to reduce stormwater impacts.
- The project will need to obtain coverage under the Construction General Permit from the State Water Resources Control Board if the project will be disturbing one acre or more of soil. See: [www.waterboards.ca.gov/water\\_issues/programs/stormwater/construction.html](http://www.waterboards.ca.gov/water_issues/programs/stormwater/construction.html).

### Planning Permit Submittal - Step 3: Incorporate Site Design Measures

Design the project to minimize the overall coverage of paving and roofs, with a special focus on reducing the amount of impervious area that is directly connected to the storm drain system. Using site design measures to reduce impervious surfaces on the site can **reduce the size of stormwater control measures** that will need to be installed. But remember: even vegetated areas will generate some runoff. If runoff from landscaped areas flows to a stormwater treatment measure, that treatment measure will need to be sized to handle these relatively small amounts of runoff, as well as runoff from impervious surfaces. Using self-treating areas (described below) can reduce the size of treatment measures even further.

#### Key Point

Using site design measures to reduce impervious surfaces on the site can reduce the size of stormwater control measures that will need to be installed.

Figure 3-2 provides an example of a site design measure. More information on site design measures is provided in Chapter 4, along with technical guidance for green roofs, pervious pavement, unit pavers and turf block. A range of site design examples are described in the following list.

- Use **alternative site layout techniques** to reduce the total amount of impervious area. This may include designing compact, multi-story structures or clustering buildings. Some cities may allow narrow streets.
- **Minimize surface parking** areas, in terms of the number and size of parking spaces. See Chapter 3 of the GI Design Guide for guidance on efficient parking lot design.
- Use **rainwater as a resource**. Capturing roof runoff in cisterns can be a practical way to reduce the amount of runoff from the site and store rainwater for use in on-site irrigation. Rainwater storage in cisterns may be used to reduce the amount of stormwater that must be treated and, where applicable, retained on-site to meet hydromodification management requirements.

- Use **drainage as a design element**. Bioretention areas, depressed landscape areas, tree well filters, vegetated buffers, and flow-through planters can serve as visual amenities and focal points in the landscape design of the site. See Chapter 6 for more information on specific treatment measures.
- **Maximize choices for mobility**. Motor vehicles are a major source of pollutants in stormwater runoff. Projects should promote, or at least accommodate, modes of transportation other than the automobile.
- Include alternative, pervious surfaces. **Green roofs** can partially or fully replace traditional roofing materials. **Pervious pavement** such as turf block, unit pavers, or other types of pervious pavement may be appropriate for sidewalks, parking lots, and low-volume residential areas.
- Identify **self-treating areas**. Some portions of the site may provide “self-treatment” if properly designed and drained. Such areas may include conserved natural spaces, large landscaped areas, and areas of turf block. These areas are considered “self-treating” because infiltration and natural processes that occur in these areas remove pollutants from stormwater. As long as the self-treating areas do **not receive runoff from impervious areas** on the site and integrated pest management is used, the drainage design may direct the runoff from self-treating areas directly to the storm drain system or other receiving water. More information on self-treating areas is given in Section 4.2.
- Direct **runoff to depressed landscaped areas**. An area may be designed within the site to function as a Self-Retaining area in which the amount of stormwater runoff that is required to be treated is infiltrated or retained in depressed landscaped areas. A 2:1 ratio of impervious area to the receiving pervious area may be acceptable, where soils permit. Much higher ratios are possible if the runoff is directed to a bioretention area, tree well filter, or other landscape-based treatment measures. More information is provided in Section 4.3.



Figure 3-2: Turf block fire access road, Santa Clara University, Santa Clara

### Planning Permit Submittal - Step 4: Measure Pervious and Impervious Surfaces to Determine Project C.3 Regulation Status and MRP Requirements

The **C.3 and C.6 Development Review Checklist** that is provided by the **local jurisdiction** must be completed as part of the planning permit application submittal (some jurisdictions also use a “Small Projects Checklist”). These documents are used to calculate the amount of impervious surface that will be created, retained and/or replaced, and to determine whether treatment and/or HM measures are required. Impervious surfaces are those areas in development projects which prevent water from infiltrating into the ground and results in runoff. Impervious surfaces include but are not limited to:

- Footprints of all buildings and structures, including garages, carports, sheds, etc.;
- Driveways, patios, parking lots, decking; and
- Streets and sidewalks.

#### Contact

Contact the local jurisdiction with any questions about the C.3 and C.6 Development Review Checklist.

### Remember

Areas of pervious pavement that infiltrate water into the ground and are underlain with storage aggregate, such as a gravel layer sufficient to hold at least the Provision C.3.d volume of rainfall runoff are not considered impervious surfaces; these areas are excluded from the calculation of impervious surfaces.

Review the thresholds in Section 2.3.1 to identify the stormwater control requirements for the project.

Also see Section 2.3.1 for information on projects that are “grandfathered in” under previous permit requirements.

Hydromodification management (HM) is required for projects that create and/or replace one acre or more of impervious surface, increase the amount of impervious surface over the pre-project condition, AND are located in susceptible areas identified in the Hydromodification Management Susceptibility Map (see Appendix H). Section 7.3 describes this map and provides more details on the requirements.

### Planning Permit Submittal - Step 5: Determine if Special Project LID Treatment Reduction Credits Apply

LID treatment reduction credits can be applied to smart growth, high density or affordable housing development projects that meet specific criteria for the Special Projects included in Appendix J. Contact municipal staff to determine whether the project meets the criteria to be considered a Special Project.

### Planning Permit Submittal - Step 6: Determine if Rainwater Harvesting Will Be Used

Rainwater harvesting and use can be complicated to implement as a means of compliance with C.3 treatment requirements as it requires a high demand for stormwater use. Appendix I provides guidance on sizing and designing systems for rainwater harvesting.

### Planning Permit Submittal - Step 7: Select Treatment/HM Measures

Stormwater treatment must be accomplished with LID techniques, i.e., with infiltration, evapotranspiration, rainwater harvesting and use, and/or biotreatment measures. **Chapter 6** provides technical guidance for specific types of stormwater treatment measures that are commonly used in San Mateo County. While other treatment measures may be approved, the review of the project will be expedited by closely following the guidance provided in Chapter 6.

Selecting the appropriate treatment measure(s) for a specific site is a matter of professional judgment. Some general factors to consider are offered below.

- Systems with high flow rate media in cartridges or in tree well filters are allowed only on Special Projects -see Appendix J.
- Is Hydromodification management (HM) required? If the project needs to meet both treatment and HM requirements, it is recommended that stormwater control measures be designed to meet both treatment and HM

### Warning

It is important to consider soil suitability, especially for treatment measures that rely primarily on infiltration.

needs where feasible. HM detention requirements are likely to exceed the volume required for treatment and may also need to be coordinated with separate requirements for flood control detention.

- Soil suitability. Soils are classified into four hydrologic soil groups – A, B, C, and D – with the soils in each group having similar runoff potential under similar storm and cover conditions. Group A soils generally have the lowest runoff potential, and group D have the greatest. Treatment measures that rely primarily on infiltration, such as infiltration trenches, are generally unsuitable for use in group D soils (clay loam, sandy clay and clay) and have the potential to fail in some group C (silt loam) soils. Bioretention areas installed in group C and D soils typically require subdrains.
- Site slope. LID treatment measures need to be carefully selected and designed for use on steep slopes, because infiltration of stormwater runoff can cause geotechnical instability. Depending on site conditions, it may be possible to design terraced bioretention cells using check dams for projects on sites with some slope constraints. See Section 6.1 for more guidance.
- Considerations for larger sites. Some sites may have sufficient space to use one or more cisterns to use rainwater for non-potable uses, such as irrigation or flushing toilets. Alternatively, smaller stormwater treatment measures may be dispersed throughout the site.
- Consider maintenance requirements. The amount of maintenance that a stormwater treatment measure will require should be considered when selecting treatment measures. As described in Section 3.3, a maintenance plan for stormwater treatment measures will need to be prepared and submitted with the building permit application. Section 8.2 provides information about the maintenance requirements for various treatment measures.
- Avoid mosquito problems. Mosquito control guidance provided in Appendix F needs to be implemented for all stormwater treatment measures, with special consideration given to treatment measures that are designed to include standing water. Underground mechanical systems can be particularly problematic because many retain water that is not visible from the surface. Project plans that include stormwater treatment measures (and their maintenance plans), may be routed to the San Mateo County Mosquito Abatement District for review. Mosquito Abatement District staff may be consulted for guidance.
- Potential for groundwater contamination. Before selecting an infiltration device, such as an infiltration trench, infiltration basin, or French drain, review the infiltration considerations presented in Appendix E to protect groundwater from contamination by pollutants in stormwater runoff.



Figure 3-3: Playing Fields/Detention Area, Pacific Shores, Redwood City (Credit: Pacific Shores, [www.pacificshores.com](http://www.pacificshores.com))

### Warning

The **mosquito control guidance** (Appendix F) needs to be implemented for all stormwater treatment measures, especially treatment measures designed to include standing water.

### Planning Permit Submittal - Step 8: Locate On-site and Off-Site Treatment/HM Measures

Review the existing and proposed on-site and off-site drainage network and connections to drainage systems offsite, which were collected in Step 1. Selecting appropriate locations for treatment and HM measures involves a number of important factors, including the following.

- **Design for gravity flow.** If at all possible, treatment/HM measures should be designed so that drainage into and out of the treatment measure is by gravity flow. This promotes effective, low-maintenance operation and helps avoid mosquito problems. Pumped systems should be considered the last design resort, as they are more expensive, require more maintenance, and can create hidden underground areas of standing water and mosquito breeding.
- Determine **final ownership and maintenance responsibility.** All treatment measures should be available for ready access by maintenance workers, inspectors from the local municipality, and staff from the San Mateo County Mosquito and Vector Control District. If the property will be subdivided, be sure to locate shared treatment measures in a common, accessible area – not in the backyard of private residential lots, if possible.
- Incorporate **treatment measures in the landscape design.** Almost every project includes landscaped areas. Most zoning districts require a certain amount of open space, and some require landscaped setbacks or buffers. It may be possible to locate some/all of the project's treatment/HM measures within required landscape areas.
- **Plan for maintenance.** Stormwater treatment measures will need to be accessible to the largest piece of equipment that will be needed for maintenance. For example, bioretention areas need access for the types of machinery used for landscape maintenance. Large extended detention basins need to have a perimeter access road accessible by heavy vehicles for sediment removal and control of emergent vegetation. Underground treatment measures and media filters may require special equipment for periodic cleanout and media replacement.

#### Remember

Plan ahead for future maintenance needs.

### Planning Permit Submittal - Step 9: Preliminary Design of Treatment/HM Measures

The preliminary design of the selected stormwater treatment measures should be performed using the hydraulic sizing criteria in Section 5.1 and the technical guidance for specific types of treatment measures in Chapter 6.

If the project is required to include HM measures, these measures should be sized using the **Bay Area Hydrology Model** (BAHM) developed by SMCWPPP in cooperation with the Santa Clara Valley Urban Runoff Pollution Prevention Program and the Alameda Countywide Clean Water Program. The BAHM was updated in 2023, and this version should be used to do the sizing analysis. The model results should be provided with the planning permit submittal. The BAHM 2023 may be downloaded at <http://www.clearcreeksolutions.info/downloads>. See Chapter 7 for more information on the BAHM and the design of HM measures.

Detailed construction drawings may not be required for planning permit submittals, but drawings or sketches need to be included to illustrate the proposed design and sizing information based on runoff calculations. Enough information should be provided to allow verification that the proposed treatment measures will work for the site and that sufficient space is allocated for installation of these measures, to avoid major modifications after planning approval. The level of information needed will vary depending on

site context and complexity of the proposed treatment concept. For example, if the treatment concept relies on the use of infiltration, representative soil permeability testing should be performed.

### Planning Permit Submittal - Step 10: Consider Planting Palettes for Treatment Measures

The selection of appropriate plant materials is an important part of designing a successful LID stormwater treatment measure. Plants need to be hardy, low-maintenance, and tolerant of saturated soils. Although irrigation systems are typically required for landscape-based stormwater treatment measures, selecting plants that can survive long periods with little or no rainfall will **help reduce irrigation requirements**. At the planning permit phase of the project a detailed planting plan is typically not required, but many municipalities require a conceptual planting palette. Appendix A provides guidance regarding the selection of plant materials for landscape-based treatment measures, including information about regenerative landscaping (Rescape). Guidelines are available at [www.rescapeca.org](http://www.rescapeca.org).<sup>13</sup>

#### Try this

Selecting plants that can survive long periods with little or no rainfall will **help reduce irrigation requirements**.

### Planning Permit Submittal - Step 11: Prepare a Preliminary Maintenance Plan (if Required)

#### Contact

Contact the local jurisdiction for more specific maintenance requirements for the project.

A stormwater treatment measure maintenance plan describes how stormwater treatment measures will be maintained during the years and decades **after construction is completed**. In some cases a municipality may require the submittal of a preliminary maintenance plan as part of the planning permit submittal. Otherwise, a maintenance plan is required only as part of the building permit submittal. **The local jurisdiction should be contacted** regarding the requirements for the project.

A preliminary maintenance plan identifies the **proposed maintenance activities**, and the intervals at which they will be conducted, for each stormwater treatment measure included in the project. As part of the building permit submittal, applicants will also need to provide additional information that will be included in a maintenance agreement between the local municipality and the property owner. Chapter 8 provides more information about stormwater treatment measure operation and maintenance (O&M), including guidance on how to prepare a maintenance plan. Maintenance plan templates for various types of stormwater treatment measures are included in Appendix G. Chapter 6 of the GI Design Guide also has helpful information on O&M of stormwater measures.

<sup>13</sup> The Bay-Friendly Landscaping Coalition is now called ReScape.

### Planning Permit Submittal - Step 12: Use Applicable Source Control Measures

Pollutants may be generated by the activities that will occur on the site after construction is completed. The Countywide Program created a model Source Control List, and local jurisdictions may have additional or modified requirements for projects that include landscaping, swimming pools, vehicle washing areas, trash/recycling areas, and other potential sources of pollutants. Some jurisdictions may prohibit the use of pesticides and synthetic fertilizers and/or require sustainable landscaping practices such as those described in the ReScape program<sup>14</sup>. These requirements are identified in the agency's **Source Control Measures List** that may be attached to conditions of approval.

#### Contact

Be sure to obtain the current list of Local Source Control Measures from the permitting jurisdiction.

**Be sure to obtain the current list from the local jurisdiction.** The lists typically focus on **structural source controls**: permanent features that are designed and constructed as part of a project, such as sanitary sewer connections for restaurant wash areas that are large enough to wash the largest piece of equipment. The municipality may also require the project to commit to implementing operational source controls: "good housekeeping" activities that must be conducted routinely during the operations phase of the project, such as street sweeping, regenerative (ReScape) landscaping maintenance and cleaning storm drain inlets.

#### Key Point

The project will need to incorporate the applicable source controls for any project activity that is included in the local source control list. The following methods may be used to accomplish this.

- **Review** structural source controls in the local list and compare this list to the site plan. Identify any areas on the site that require structural source controls. Remember that some activities may not have been sited yet. For example, the Model List includes a requirement for enclosing and roofing refuse storage areas. If a designer was unaware of this requirement, it may not be shown on the project plans.
- **Incorporate** all the required structural source controls on the project drawings.
- **If required by the municipality**, prepare and submit a table, listing in three columns the potential sources of pollutants, the permanent source control measures, and any operational source control measures from the local list that apply to the project. Table 3-2 is a Table of Example Source Controls.

<sup>14</sup> [www.rescapeca.org](http://www.rescapeca.org)



Table 3-2: Table of Example Stormwater Source Controls

Potential Source of Pollutants	Structural Source Controls	Operational Source Controls
On-site storm drains	On-site storm drains shall be marked with the words “No Dumping! Flows to Bay” (or applicable water body) applied with thermoplastic or a medallion.	All on-site storm drain inlets shall be cleaned at least once a year immediately prior to the rainy season.
Refuse areas	New or redevelopment projects, such as food service facilities, multi-family dwelling projects and many commercial projects shall provide a roofed and enclosed area for trash, compost, and recycling containers. The area shall be designed to prevent water run-on to the area and runoff from the area and to contain litter and trash, so that it is not dispersed by the wind or runoff during waste removal.	Keep trash area clean, bins closed, and make sure bins are appropriately sized.
NOTE: This is included as an example only and is not intended for use in an actual submittal.		

### Planning Permit Submittal - Step 13: Coordinate with Other Project Requirements

When submitting the C.3 stormwater drawings with the planning permit submittal, the stormwater site design, source control, treatment and HM measures may be shown on a separate stormwater plan, or combined with the site plan, landscaping plan, or drainage plan – depending on the complexity of the project. Whether plans are combined or separate, there are a number of issues that must be carefully coordinated with other aspects of the project design. Some typical coordination considerations are listed below.

- **Balance of Cut and Fill.** When calculating the overall project balance of cut and fill, be sure to include the excavation of stormwater treatment measures (including the need to replace existing clay soils with group A or B soils).
- **Soil Compaction during Construction.** Compaction from construction traffic can severely restrict the infiltration capacity of soils at the site. In the construction staging plan, protect and limit operation in those portions of the site that will be used for self-treatment or stormwater treatment measures that rely on infiltration.
- **Building Drainage.** Building codes require that drainage from roofs and other impervious areas be directed away from the building. The codes also specify minimum sizes and slopes for roof leaders and drain piping. Any stormwater measure located in or on the building, or that may affect building foundations, must be designed to meet the minimum building code requirements. Stormwater treatment measures are also required to meet the requirements for detention or flow described in Section 5.1.

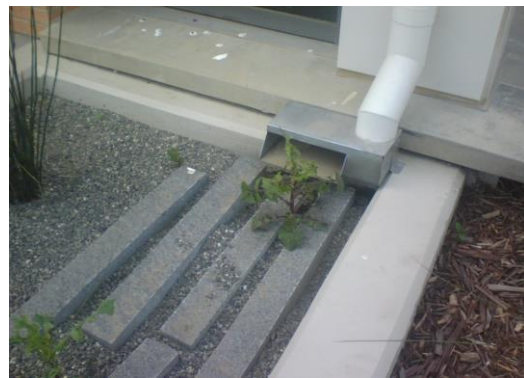


Figure 3-4: Splash block/box and flow spreaders help prevent erosion as stormwater enters treatment measure. (Credit: EOA, Inc.)

**Warning**  
Be aware of potential elevation control requirements.

- **Control of Elevations.** Getting runoff to flow from impervious surfaces to landscaped surfaces may require greater attention to detailed slopes and elevations in grading and landscaping plans. For example:
  - **Provide Adequate Change in Elevation** between the pavement and vegetated areas. The landscaped area needs to be low enough so that runoff will flow into it even after the turf or other vegetation has grown up. If an adequate drop in elevation is not provided, runoff will tend to pond on the edge of the paved surface.
  - **Provide for Differential Settlement.** While the soil in landscaped-based stormwater treatment measures and self-treating areas must be left loose and uncompacted, concrete structures (such as inlets and outlets) must be supported on a firm foundation. Otherwise they may settle more than the surrounding ground, creating depressions that can hold standing water and contribute to nuisances such as mosquito breeding.
- **Prevent Erosion.** There is potential for erosion to occur at points where the stormwater runoff flows from impervious areas into landscape-based treatment measures. Include in project plans any proposed erosion controls, such as splash blocks and flow spreaders, such as shown in Figure 3-4.
- **Drainage Plans.** The local building or engineering department may require a drainage plan, which typically focuses on preventing street flooding during a 10-year storm and demonstrating that flooding from 100-year storms can be managed. To meet the drainage plan requirements it may be necessary to include **high flow bypasses** in the design of stormwater treatment measures, in order to route **flood flows** directly to the storm drain system. More information on this topic is provided in Section 5.6. The local jurisdiction should be consulted regarding the need to prepare a drainage plan, and whether it is required only as part of the building permit submittal, or if a preliminary drainage plan is needed with the planning permit submittal.
- **Signage for Traffic and Parking.** If the project includes depressed landscaped areas next to parking lots, driveways or roadways, it may be necessary to include bollards, striping or signs to guide traffic, particularly if curbs are designed to be flush with the pavement. Traffic striping may not be practical for pervious pavement such as crushed aggregate and unit pavers. In these areas signs and bollards may be needed to help direct traffic.

### Contact

Contact the local jurisdiction to learn more about signage requirements.

## Planning Permit Submittal - Step 14: Submit Planning Permit Application

Assemble all the items listed in Table 3-1 that municipal staff indicates are required for the project, and include them as attachments to the planning permit application for the project.

### 3.3 How to Prepare Building Permit Submittals

Except for projects on small sites, the principal differences between planning permit submittals and building permit submittals are:

- **Construction level detail**, rather than preliminary plans, are submitted;
- Changes are **highlighted and explained**, if plans differ from the planning permit submittal; and
- **Detailed maintenance plans** are included, along with documentation to support the maintenance agreement.

#### Key Point

If the project **does not require a planning permit**, then the building permit application submittal will need to include some items from Tables 3-1 and 3-3.

The list of materials that may be required at this stage in the project is shown in Table 3-3, and brief step-by-step instructions follow.

#### Building Permit Submittal - Step 1: Update Project Documentation

Information regarding the design of stormwater measures that was submitted with the planning permit application must be updated, as necessary, for submittal with the building permit application. Specific requirements may vary in the various jurisdictions, but this is anticipated to include the following:

#### Contact

Contact the local jurisdiction to learn more about specific requirements for the project

- Incorporate all **stormwater-related conditions of approval** that were applied as part of planning permit approval;
- Include a “Stormwater Management Plan” sheet in the civil and/or landscape plans summarizing the control measures, drainage management areas, and other related features;
- Highlight and explain any **other stormwater-related changes** that have been made since the planning review. This may include, but is not limited to, changes in the boundaries of sensitive areas to be protected, changes in the amount of impervious surface to be created/replaced, changes in the stormwater pollutant source areas, changes in the location or design of stormwater measures, etc;
- Prepare **construction level detail** for all stormwater measures included in the project;
- Prepare detailed **hydraulic sizing calculations** for stormwater treatment and HM measures, using the hydraulic sizing guidance provided in Section 5.1 and Sections 7.5-7.6; and
- Prepare construction-level **planting plans** for landscape-based stormwater treatment measures.

NOTE: Some **smaller projects** may not require a planning permit. If this is true for the project, the building permit application submittal will need to include items listed in both Table 3-1 and Table 3-3. Ask the building department staff to help identify the specific items needed for the submittal.

Table 3-3: Building Permit Submittal Checklist

Required?		Information on Project Drawings	Corresponds to Building Step (Sect. 3.3)
Yes	No		
<input type="checkbox"/>	<input type="checkbox"/>	Sensitive natural areas to be preserved and protected from development. – highlighting any changes since the planning permit submittal.	Step 1
<input type="checkbox"/>	<input type="checkbox"/>	Proposed impervious surfaces, e.g., roof, sidewalk, street, parking lot (for each drainage area, on-site and off-site)–highlight any changes since planning submittal.	Step 1
<input type="checkbox"/>	<input type="checkbox"/>	Site design measures to minimize impervious surfaces and promote infiltration – construction level detail.	Step 1
<input type="checkbox"/>	<input type="checkbox"/>	Construction level detail of stormwater treatment measures for regulated projects and hydromodification management measures, if required.	Step 1
<input type="checkbox"/>	<input type="checkbox"/>	Pollutant source areas and corresponding structural source controls from local source control list – construction level detail.	Step 1
<input type="checkbox"/>	<input type="checkbox"/>	Landscaping plan for stormwater treatment measures--construction level detail.	Step 1
<input type="checkbox"/>	<input type="checkbox"/>	Letter- or legal-sized conceptual or site plan showing locations of stormwater treatment measures, for inclusion in the O&M Agreement.	Step 2
		<b>Written Information on Municipal Forms or in Report Format</b>	
<input type="checkbox"/>	<input type="checkbox"/>	Updated C.3 and C.6 Development Review Checklist (or Small Projects Checklist), showing any changes since planning permit submittal.	Step 1
<input type="checkbox"/>	<input type="checkbox"/>	Detailed hydraulic sizing calculations and map of drainage management areas for each treatment and/or hydromodification management measure and narrative of treatment approach.	Step 1
<input type="checkbox"/>	<input type="checkbox"/>	List of source control measures included in the project, showing any changes since planning permit submittal.	Step 1
<input type="checkbox"/>	<input type="checkbox"/>	Detailed O&M plan for stormwater treatment measures, including inspection checklists, as appropriate.	Step 2
<input type="checkbox"/>	<input type="checkbox"/>	A standard treatment measure O&M report form, to be attached to the Maintenance Agreement	Step 2

### Building Permit Submittal - Step 2: Prepare Maintenance Documentation

#### Remember

Property owners are responsible for the long-term operation and maintenance (O&M) of a project's on-site stormwater control measures (and, depending on the jurisdiction, O&M of off-site control measures, e.g., constructed in the public right of way fronting the property), unless the applicable municipality approves other specific arrangements. Details may vary from one jurisdiction to another, but **O&M Agreements** generally require the property owner to assure that all stormwater treatment measures receive proper maintenance in accordance with an approved maintenance plan; that municipal, Water Board, and Mosquito Abatement District staff be granted access, as needed, to ensure proper maintenance and operation; and if the property owner fails to maintain the treatment measure, municipal staff be allowed, as its option, to enter the property, perform necessary emergency repairs, and charge the property owner for the necessary emergency repairs.

Project applicants are typically required to provide the following documentation to support the maintenance agreement.

- A **conceptual plan or site plan** that is legible on letter- or legal-sized paper (8.5-by-11 inches or 8.5-by-14 inches) and shows the locations of the stormwater treatment measures that will be subject to the agreement. **Some municipalities have specific requirements and/or templates** for these plans, such as requiring a conceptual plan that includes only the stormwater treatment measures. If more than one stormwater treatment measure is used, the treatment measures should be numbered for ease of identification (for example, Bioretention Area 1, Bioretention Area 2, etc.)
- A **maintenance plan** that includes specific long-term maintenance tasks and a schedule. Section 8.2 provides guidance for preparing a maintenance plan, and Appendix G features maintenance plan templates to use when preparing a maintenance plan. The GI Design Guide contains additional O&M guidance and checklists. If a preliminary maintenance plan was submitted with the planning permit application, this plan should be updated to respond to municipal staff comments and include a sufficient level of detail for implementation.
- A Standard Treatment Measure O&M **Inspection Report Form**, which some municipalities require the property owner to complete and submit to the municipality each year. The purpose of the annual report is to help the municipality verify that appropriate O&M is occurring. A template for preparing this report form is included in Appendix G.
- **As-built details** of all installed treatment and hydromodification management controls, including cross-section and plan view details and the installed plant palette, are very useful later when maintenance is required.

Typically, the O&M Agreement is recorded with the property deed at the County when project occupancy is granted.

### Building Permit Submittal - Step 3: Submit Building Application

Assemble all the items listed in Table 3-3 that municipal staff has indicated are required for the project, and include them as attachments to the building permit application.

### 3.4 Simple Instructions for Small Sites Subject to Stormwater Treatment Requirements

#### Remember

Some developers of smaller projects may be less familiar with requirements to incorporate stormwater treatment measures. A qualified engineer, architect or landscape architect may be able to prepare the entire C.3 submittal themselves. If none of these experts is available to prepare the entire submittal, then a **qualified civil engineer, architect or landscape architect** should be hired to prepare at least some of the more technical aspects of the submittal. Some tips for smaller projects are provided below.

- **Review submittal checklists with municipal staff.** If the project does not require a planning permit, then the building permit application submittal will need to include the appropriate items listed in Table 3-1 (Planning Permit Submittal Checklist) and in Table 3-3 (Building Permit Checklist). But remember, not every item in the checklists is required for every project. **An appointment should be made with a member of the Building Department staff** (or the Planning or Public Works Department, as appropriate) to review the checklists, and to generate a **reduced list** of the items that will be needed for the small site. The list should be in writing, for future references to it, if necessary, in conversations with municipal staff. If the project requires a planning permit, then this same approach should be used to generate a list of required items from the planning staff.
- **Maximize the use of site design measures.** The less impervious surface area on the site, the smaller the stormwater treatment measures will need to be. Chapter 4 lists many strategies for reducing impervious surfaces, and it offers guidance for using self-treating areas (for example, landscaped areas, areas paved with turf block, or green roofs) to further **reduce the size** of treatment measures. Small projects that create and/or replace less than 5,000 square feet of impervious surface and detached single family home projects, not part of a larger plan of development, that create and/or replace between 2,500 and 10,000 square feet of impervious surface are required to incorporate site design measures described in Appendix L (but do not require treatment measures).

#### Contact

Contact the appropriate local department to review the checklists for small sites.

- **Use LID treatment measures.** All regulated projects – even small ones – must use LID treatment measures, except for Special Projects that may receive LID treatment reduction credits (described in Appendix J). Chapter 6 includes technical guidance for many treatment measures, such as bioretention areas, and flow-through planters, which are well suited for small sites in **densely developed areas**. Bioretention areas that maximize infiltration to the underlying soils are encouraged even if it is infeasible to infiltrate the full C.3.d amount of runoff, if there are no conditions that would make infiltration unsafe. If infiltration is precluded due to on-site conditions (such as proximity to buildings, high groundwater or contaminated soils), flow-through planters, such as shown in Figure 3-5, may be a good option.



Figure 3-5: Flow-through planter in an urban setting (Credit: EOA, Inc.)

- **Avoid vault systems.** Vaults with high-flow-rate media filters are only allowed for qualifying Special Projects (see Appendix J). However, these systems in general are not as effective nor as easy to maintain as landscape-based biotreatment measures.
- **Consider using simplified sizing methods.** The technical guidance in Chapter 6 includes simplified sizing methods for several types of stormwater treatment measures, including flow-through planters, and bioretention areas. The technical guidance for each of these treatment measures highlights the easy-to-follow calculations for sizing the treatment measures. Please note, however, that there is a trade-off for simplicity. The simplified sizing calculations may result in treatment measures that are conservatively large. If space is at a premium, it may be cost-effective to hire a civil engineer with experience sizing stormwater treatment measures and use the more detailed sizing calculations, in order to potentially reduce the amount of land needed for stormwater treatment.
- **Use the planting guidance.** Appendix A provides guidance for selecting appropriate plantings for landscape-based stormwater treatment measures. Municipal staff will confirm that the plants included in the design meet the criteria set forth in this guidance.
- **Avoid the use of pumps for moving stormwater.** Whenever possible, it is better to use gravity and surface flow to convey stormwater to treatment measures. Pumps can malfunction and since they are typically out of sight, operation and maintenance issues may not be noticed. If pumps are necessary, ensure frequent maintenance checks will be performed to confirm proper operation and that backup power will be provided to the pumps when power outages occur to avoid flooding.

# Chapter 4: Low Impact Development Site Design

<i>Introduction</i> .....	4-2
4.1 <i>Self-Treating Areas</i> .....	4-4
4.2 <i>Self-Retaining Areas</i> .....	4-7
4.3 <i>Reducing the Size of Impervious Areas</i> .....	4-9
4.4 <i>Rainwater Harvesting and Use</i> .....	4-11
4.5 <i>Site Design Requirements for Small Projects</i> .....	4-12



## Introduction

Site design measures are used to reduce the project's impact on water quality and beneficial uses. Site design measures are not treatment measures. Including site design measures in a project does not meet the C.3 requirements for stormwater treatment, but it can help reduce the number and size of treatment measures (see Section 4.1). Site design measures can be grouped into two categories:

- Site design measures that *preserve sensitive areas* and high-quality open space, and
- Site design measures that *reduce impervious surfaces* in a project.

Preserving sensitive areas and high-quality open space includes the following types of sustainable practices:

- Preserving and protecting high-quality trees during construction;
- Preserving topsoil by:
  - Not disturbing or grading areas with high-quality topsoil;
  - Stockpiling topsoil during grading and using it during landscape construction;
- Preserving areas of high-quality open space;
- Protecting open space areas from equipment compaction, or if this is not possible, uncompacting soils after grading;
- Protecting water bodies by avoiding or restricting construction within 100 feet or more from banks (or as required by local ordinances or policies);
- Avoiding lime treatment of soil; and
- Avoiding grading and construction work during the rainy season or when the soil is saturated.

### Please Note

**The use of interceptor trees as a site design measure to reduce the impervious area required to be treated at a development project is no longer allowed under the current MRP.**

Trees perform a variety of functions that reduce runoff volumes and improve water quality. Leaf canopies intercept and hold rainwater on the leaf surface, preventing it from reaching the ground and becoming runoff. Root systems create voids in the soil that facilitate infiltration. Trees absorb and transpire large quantities of groundwater, making the soil less saturated, which allows more stormwater to infiltrate. Through the absorption process, trees remove pollutants from stormwater and stabilize them. Tree canopies shade and cool paved areas. Despite these many benefits, trees located near impervious surfaces ("interceptor trees") cannot be credited toward treatment of those areas.

Pruning and removal and replacement of diseased/damaged trees may be required to create a sustainable natural landscape (see Chapter 6 of the GI Design Guide for more guidance on proper tree pruning and maintenance).

The remainder of this chapter focuses on site design measures that reduce impervious surfaces, which can reduce the amount of stormwater runoff that will require treatment. This translates into fewer or smaller treatment measures than would have been required without the site design measures. Site design measures are also important in minimizing the size of any required hydromodification management

measures for the site. Site design measures to reduce stormwater runoff can be incorporated in the project in various ways described in this chapter and organized in the following sections.

- Self-Treating Areas
- Self-Retaining Areas
- Reducing the Size of Impervious Areas
- Rainwater Harvesting and Use
- Site Design Requirements for Small Projects

Where landscaped areas are designed to have a stormwater drainage function, it is important that they be installed and maintained without the use of fertilizers and pesticides. Consult the Planting Guidelines in Appendix A. Landscaped areas with stormwater drainage functions also need to be carefully integrated with other landscaping features on the site early in project design (e.g., see Chapter 5 for information on integrating trees and stormwater control measures). This may require coordinating separate designs prepared by different professionals.

Remember that any site design measures (including self-treating areas) used to reduce the size of stormwater treatment measures ***must not be removed*** from the project without a corresponding resizing of the stormwater treatment measures. For this reason, the municipality may require site design measures to be included in the maintenance agreement or maintenance plan for stormwater treatment measures, or otherwise recorded with the deed<sup>15</sup>. Depending on the municipality, site design measures may be subject to periodic operation and maintenance inspections. Check with the municipal staff regarding local requirements.

### Warning

Site design measures used to reduce the size of stormwater treatment measures **must not be removed** from the project without a corresponding resizing of the stormwater treatment measures.

---

<sup>15</sup> Pervious pavement system(s) that cover 3,000 square feet or more of area at a Regulated Project are required to be included in maintenance agreements and plans, except for projects with pervious pavement systems installed as private-use patios for single family homes, townhomes, or condominiums.

## 4.1 Self-Treating Areas

### Key Point

If self-treating areas do not receive runoff from impervious areas, **runoff from self-treating areas may discharge directly to the storm drain.**

Some portions of the site may provide “self-treatment” if properly designed and drained. Such areas may include conserved natural spaces, landscaped areas (such as parks, green roofs and lawns), and pervious pavement. These areas are considered “self-treating” because ***infiltration and natural processes that occur in these areas prevent stormwater and pollutants*** from being discharged. Areas of pervious pavement – such as pervious concrete, porous asphalt, or permeable interlocking concrete pavers – and artificial turf may function as self-treating areas if they are designed to store and infiltrate (into native soil) the runoff volume described in Provision

C.3.d of the MRP. As long as the self-treating areas are not used to receive runoff from other impervious areas on the site, and are installed and maintained without the use of pesticides or synthetic fertilizers, the drainage design may route the runoff from self-treating areas ***directly to the storm drain*** system or other receiving water. Consult Chapter 8 (Operation and Maintenance) for guidance on using regenerative landscaping and integrated pest management to avoid the use of pesticides and synthetic fertilizers. Stormwater runoff from the self-treating areas should be kept separate from the runoff from paved and roofed areas of the site, which requires treatment.

Even vegetated areas will generate some runoff. ***If the runoff from the self-treating area commingles with the C.3.d amount of runoff*** from impervious surfaces, then the stormwater treatment measure must be hydraulically sized to treat runoff from both the self-treating areas and the impervious areas. This does not apply to the high flows of stormwater that are in excess of the C.3.d amount of runoff, because stormwater treatment measures are not designed to treat these high flows. If the project requires hydromodification management, then the runoff from self-treating areas will need to be included in the sizing calculations for HM treatment measures.

**Figure 4-1** compares the size of the stormwater treatment measure that would be required to treat the runoff from a site, depending on whether the runoff from a self-treating area discharges directly to the storm drain system or other receiving water. In the first (upper) sequence, runoff from the self-treating area is directed to the stormwater treatment measure. In the second (lower) sequence, runoff from the self-treating area bypasses the treatment measure and flows directly to the storm drain system or other receiving water, resulting in a smaller volume of stormwater that will require treatment. This results in a ***smaller stormwater treatment measure***.

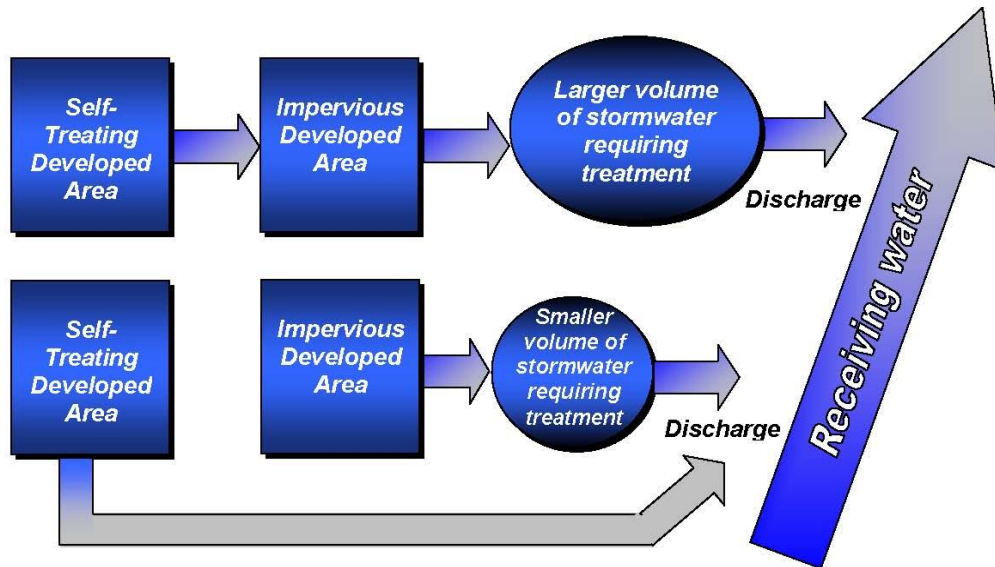


Figure 4-1: Self-Treating Area Usage (Source: BASMAA, 2003)

Figure 4-2 compares the conventional drainage approach to the self-treating area approach. The conventional approach combines stormwater runoff from landscaped areas with the runoff from impervious surfaces. Assuming the parking lot storm drain leads to a treatment measure, in the conventional approach, the treatment measure will need to be sized to treat runoff from the entire site. The **self-treating area approach** routes runoff from appropriately designed and maintained landscaped areas directly to the storm drain system. In this approach, the treatment measure is sized to treat only the runoff from impervious areas.

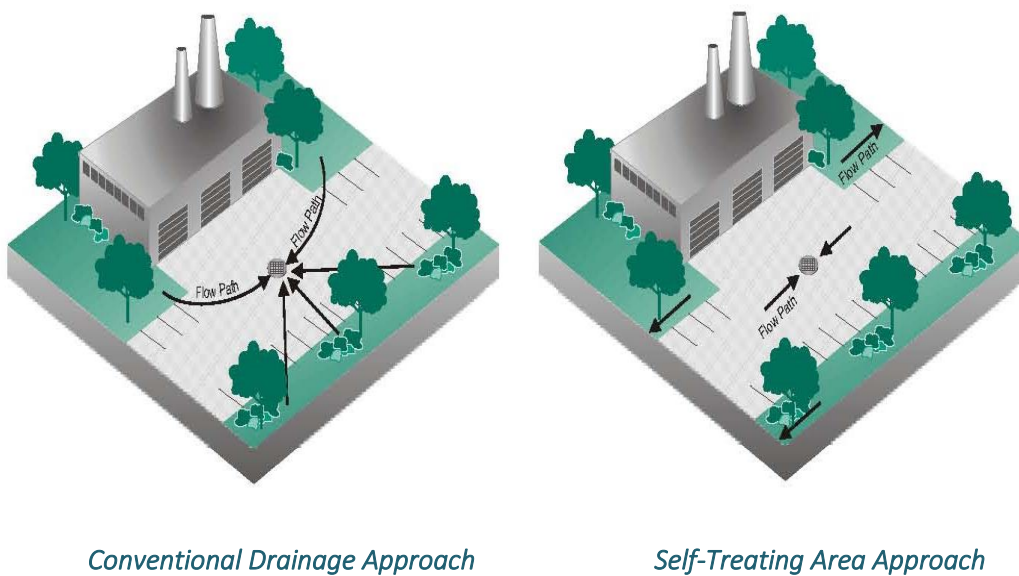
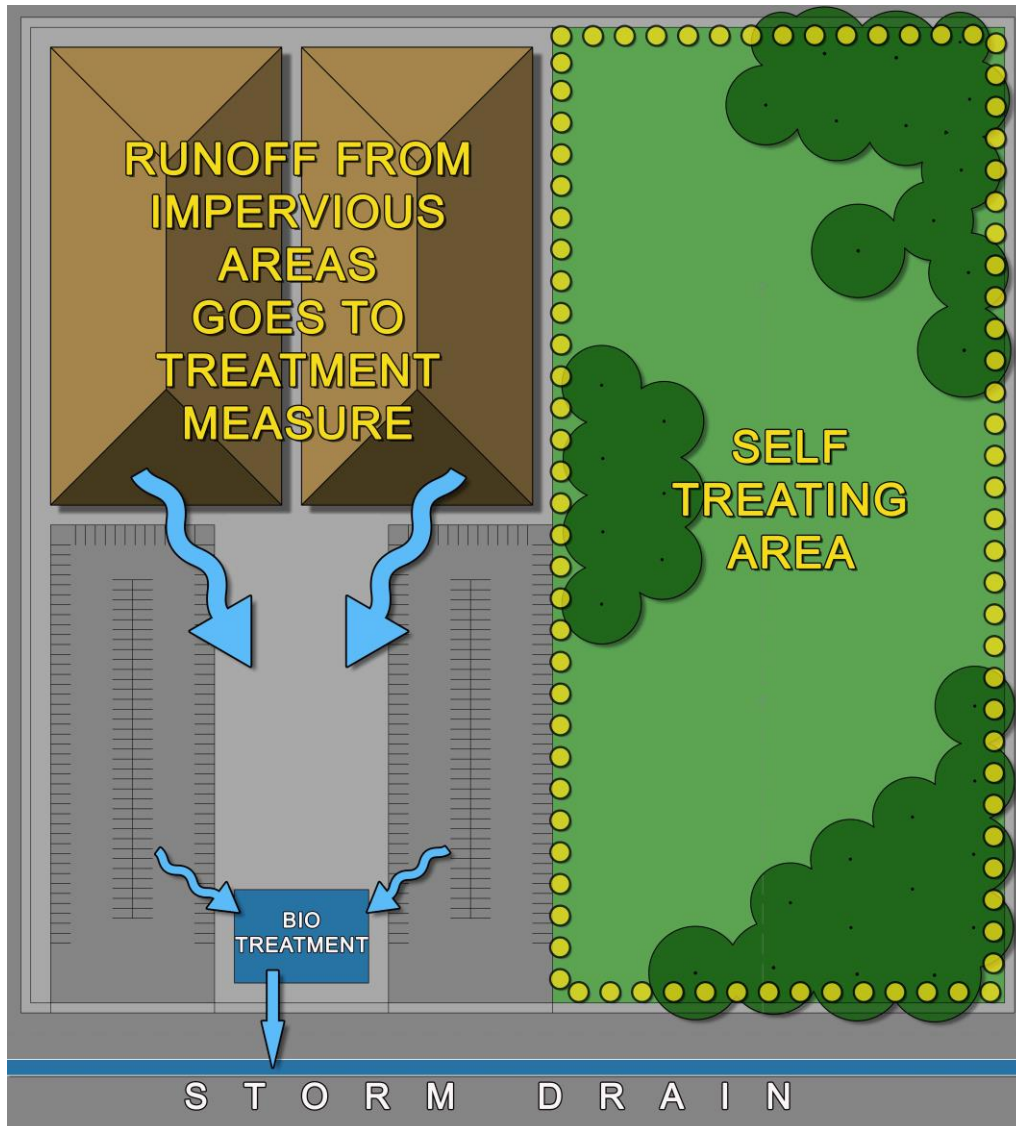


Figure 4-2: Commercial/Industrial Site Compared to Same Site with Self-Treating Areas (Source: BASMAA 2003)

**Figure 4-3** (below) shows an example site in which the runoff from impervious areas must flow to the stormwater treatment measure before discharging to the storm drain, while runoff from the self-treating area may discharge directly to the storm drain. This is allowable because the self-treating area **does not accept runoff from the impervious areas** on the site.



*Figure 4-3: Schematic Diagram of a Site with a Self-Treating Area  
(Credit: SCVURPPP)*

## 4.2 Self-Retaining Areas

In “self-retaining areas” or “zero discharge areas,” a portion of the amount of stormwater runoff that is required to be treated is infiltrated or retained in depressed landscaped areas, or in properly-designed areas of pervious pavement. If it is possible to create a self-retaining area on the site, smaller stormwater treatment measures can be designed (as illustrated in Figures 4-4 and 4-5). ***Drainage from roofs and paving is directed to the self-retaining area***, where it can be temporarily stored before infiltrating into the soil. Self-retaining areas may be created by designing concave landscaped areas at a lower elevation than surrounding paved areas, such as walkways, driveways, sidewalks and plazas (as illustrated in Figure 4-5); or by designing areas of pervious pavement to accept runoff from impervious surfaces. The following design considerations apply to self-retaining areas.

- Landscaped self-retaining areas are designed as concave areas that are bermed or ditched to retain the first one-inch of rainfall without producing any runoff. Modeling conducted for the Harvest and Use, Infiltration and Evapotranspiration Feasibility/Infeasibility Criteria Report (Feasibility Report) demonstrated that a ponding depth of 3 inches is sufficient to meet the C.3 stormwater treatment objective (at a 2:1 impervious to pervious area ratio).
- Pervious pavement designed as a self-retaining area must provide adequate storage in the void space of the gravel base layer to accommodate the volume of runoff specified in Provision C.3.d of the MRP for both the area of pervious pavement and the impervious surfaces that contribute runoff. The area must allow for infiltration of water and not be lined with impervious materials or constructed over an impervious barrier.
- Runoff may enter the self-retaining area as sheet flow, or it may be piped from a roof or area of impervious pavement. The elevation difference between a landscaped self-retaining area and adjacent areas should be sufficient to allow build-up of turf or mulch within the self-retaining area.
- ***A maximum 2:1 ratio of impervious area to the receiving pervious area is acceptable.*** Modeling conducted for the BASMAA LID Feasibility Criteria Report confirmed that a 2:1 ratio is sufficient to achieve the C.3.d stormwater treatment objective, even for soils with very low hydraulic conductivity. The 2:1 ratio applies to both landscaped areas, pervious pavement, and artificial turf areas that are designed as self-retaining areas.
- Drainage from self-retaining areas (for amounts of runoff greater than the first one-inch) must flow to off-site streets or storm drains without flowing onto paved areas within the site.
- If overflow drains or inlets to the storm drain system are installed within a landscaped self-retaining area, set them at an elevation of at least 3 inches above the low point to allow ponding. The overflow drain or storm drain inlet elevation should be high enough to allow ponding throughout the entire surface of the self-retaining area.
- Any impervious pavement within the self-retaining area (e.g., a sidewalk through a landscaped area) cannot exceed 5 percent of the total self-retaining area.
- Slopes may not exceed 4 percent.
- The municipality may require amended soils, vegetation and irrigation to maintain soil stability and permeability.
- Self-retaining areas shall be protected from construction traffic and compaction.

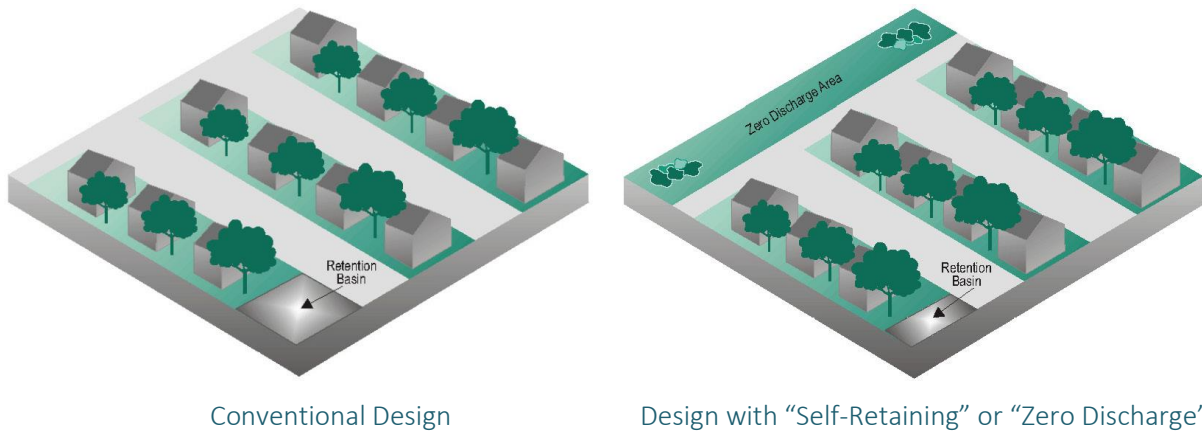


Figure 4-4: Allowing some runoff from impervious surfaces to be retained and infiltrate in a “self-retaining” or “zero discharge” area can reduce the size of the required stormwater treatment measure. (Source: BASMAA 2003)

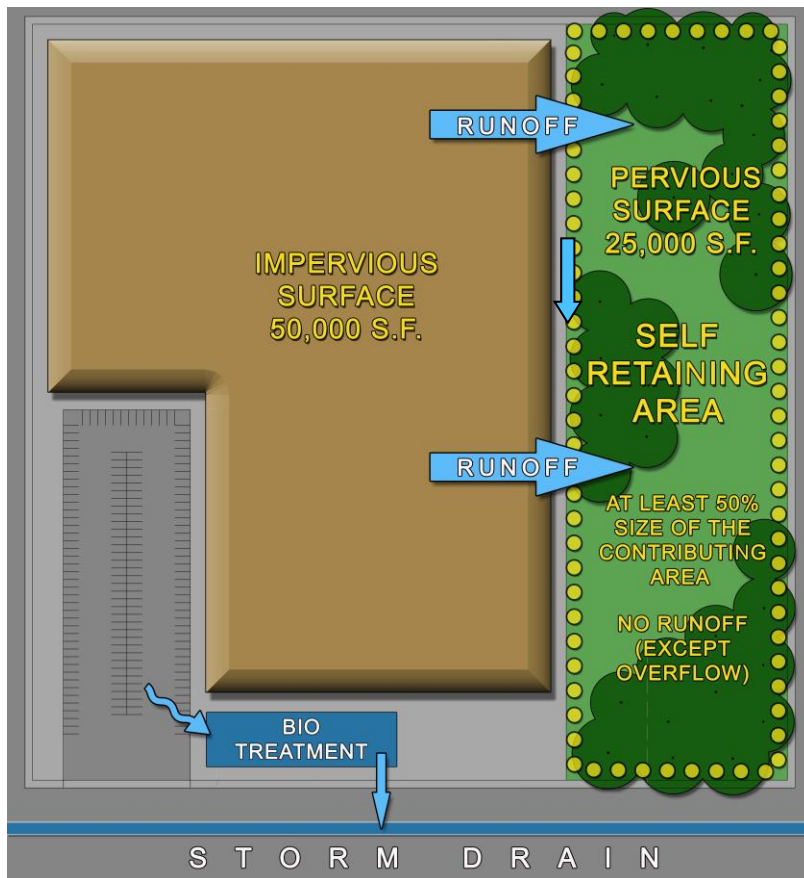


Figure 4-5: Schematic Drainage Plan for Site with a Self-Retaining Area (Credit: SCVURPPP)

### 4.3 Reducing the Size of Impervious Areas

A variety of project features can be designed so that they result in a smaller “footprint” of impervious surface. These techniques generally need to be incorporated very *early in the project design*. Several techniques for reducing impervious surfaces are described below.

#### Key Point

Site designs that reduce the size of impervious area generally need to be incorporated very early in the project design.



Figure 4-6: Installation of permeable interlocking concrete pavers in Oakland. Water infiltrates through gravel in the joints between the pavers. (Courtesy of the City of Oakland)

#### Alternative Site Layout Techniques

Check with the local jurisdiction about its policies regarding the following site design measures:

- Reduce building footprints by using compact, *multi-story structures*, as allowed by local zoning regulations.
- *Cluster buildings* to reduce the length of streets and driveways, minimize land disturbance, and protect natural areas.
- *Design narrow streets* and driveways, as allowed by the local jurisdiction.
- *Using sidewalks on only one side* of the street may be appropriate in areas with little pedestrian and vehicular traffic, as allowed by the local jurisdiction.



### Minimize Surface Parking Areas

A variety of techniques can be used to minimize surface parking areas, in terms of the number and size of parking spaces, as allowed by the local jurisdiction. These solutions focus on either reducing the demand for parking, maximizing efficient use of parking space, or implementing design solutions to reduce the amount of impervious surface per parking space. **See Chapter 3 of the GI Design Guide** for more guidance on maximizing the efficiency of parking areas.

- Reduce parking demand by **separating the cost of parking** from the cost of housing or leasable space. This allows the buyer or tenant to choose how much parking they actually need and are willing to pay for.
- Maximize efficient use of parking space with **shared parking** that serves different land uses that have different times of peak demand. For example, an office use with demand peaks during the day can share parking with restaurants, where demand is greatest during the evening, and to some extent residential uses, where demand peaks are in the evenings, nights and on weekends.
- **Parking structures** can be an efficient way to reduce the amount of impervious surface needed for parking. Structured parking can be integrated with usable space in buildings that also house office or residential space, or include ground-floor retail lining the street. Shared parking strategies can work very well with structured parking.
- **Parking lifts** are another way to reduce the amount of impervious surface needed for parking. A parking lift (shown in Figure 4-7) stacks two to three cars using a mechanical lift for each surface space. They can be operated manually by residents or employees, or by a valet or parking attendant. With proper training for residents, employers, or parking attendants, this strategy can be a practical way to double or triple the parking capacity given a set amount of land.
- Another way to maximize the efficient use of parking area is **valet parking**, where attendants park cars much closer than individual drivers would in the same amount of parking space.



*Figure 4-7: Parking Lifts in Parking Garage, Berkeley (Courtesy of City of Berkeley)*

## 4.4 Rainwater Harvesting and Use

Technical guidance for rainwater harvesting and use is provided in Section 6.9 and Appendix I. A rainwater harvesting system is considered a stormwater treatment measure if it is designed to capture and use the full amount of rainwater runoff that is required to be treated per Provision C.3.d of the MRP. A rainwater harvesting system is considered a site design measure if it is designed to capture and use less than the C.3.d amount of runoff. If the project will include a rainwater harvesting system as a site design measure, follow the guidance in Section 6.9, with the exception of meeting the C.3.d stormwater treatment sizing criteria.



*Figure 4-8: Rainwater Harvesting Cistern at Mills College, Oakland (Credit, EOA, Inc.)*

## 4.5 Site Design Requirements for Small Projects

As stated in section 2.3.3, Provision C.3.i of the MRP requires small projects that meet either of the following thresholds to include one of six site design measures listed below:

- Individual detached single-family home projects not part of a larger plan of development that create and/or replace between 2,500 and 10,000 square feet of impervious surface; or
- Other small projects that create and/or replace between 2,500 and 5,000 square feet of impervious surface.

Applicable projects must implement at least one of the following site design measures:

- Direct roof runoff into cisterns or rain barrels for use;
- Direct roof runoff onto vegetated areas;
- Direct runoff from sidewalks, walkways, and/or patios onto vegetated areas;
- Direct runoff from driveways and/or uncovered parking lots onto vegetated areas;
- Construct sidewalks, walkways, and/or patios with pervious pavement; or
- Construct bike lanes, driveways, and/or uncovered parking lots with pervious pavement.

To help select site design measures appropriate for small projects that meet the thresholds described above, the Countywide Program collaborated regionally through the Bay Area Stormwater Management Agencies Association (BASMAA) and developed the following four fact sheets.

- Managing Stormwater in Landscapes
- Rain Gardens
- Pervious Paving
- Rain Barrels and Cisterns

These factsheets, and further detail on implementing site design for small projects, are presented in Appendix L.

To supplement guidance provided in the regional fact sheets, refer to Table L-2 to identify key opportunities and constraints for the site design measures listed in Provision C.3.i. Choose one or more site design measures that are a good match for the project site. Only one site design measure is required for small projects, but additional measures may be selected to increase the water quality benefits of the project.

Additional information on site design measures can be found in the GI Design Guide.

# Chapter 5: General Technical Guidance for Treatment Measures

<i>Introduction</i> .....	5-2
<i>5.1 Hydraulic Sizing Criteria</i> .....	5-2
5.1.1 Volume-Based Sizing Criteria.....	5-3
5.1.2 Flow-Based Sizing Criteria .....	5-5
5.1.3 Combination Flow and Volume Design Basis.....	5-8
<i>5.2 Applicability of Non-Low Impact Development (LID) Treatment Measures</i>	5-12
<i>5.3 Using Manufactured Treatment Measures</i> .....	5-13
<i>5.4 Using Treatment Trains</i> .....	5-14
<i>5.5 Infiltration Guidelines</i> .....	5-15
<i>5.6 Bypassing High Flows</i> .....	5-16
<i>5.7 Plant Selection and Maintenance</i> .....	5-18
<i>5.8 Mosquito Control</i> .....	5-20
<i>5.9 Incorporating Treatment with Hydromodification Management</i> .....	5-21
<i>5.10 Treatment Measures in Areas of Bay Fill</i> .....	5-22
<i>5.11 Treatment Measures in Seismic Hazard Areas</i> .....	5-23
<i>5.12 Artificial Turf and Stormwater Treatment</i> .....	5-24
<i>5.13 Getting Water into Treatment Measures</i> .....	5-25
<i>5.14 Underdrain</i> .....	5-32
<i>5.15 Integrating Trees and Stormwater Treatment</i> .....	5-35

## Introduction

This general technical information in this section applies to the full range of stormwater treatment measures for all types of new development and redevelopment projects. See Chapter 6 for technical guidance tailored to specific types of stormwater treatment measures. See Chapter 3 and 4 of the GI Design Guide for example designs incorporating the typical guidance recommendations included in this chapter.

### 5.1 Hydraulic Sizing Criteria

Stormwater treatment measures on regulated projects<sup>17</sup> are sized to treat runoff from **relatively small sized storms** that comprise the vast majority of storms. The intent is to treat most of the stormwater runoff, recognizing that it would be infeasible to size stormwater treatment measures to treat runoff from large storms that occur every few years. (See Section 5.6 for more information on how stormwater treatment measures that are sized to treat runoff from small, frequent storms can be designed to also handle flows from large, infrequent storms)

#### How Much of the Project Site Needs Stormwater Treatment?

The Municipal Regional Stormwater Permit requires all regulated projects to provide stormwater treatment for runoff from the project site. Municipalities may require stormwater treatment for projects that are smaller than the regulated project threshold or meet other criteria, and in these cases, stormwater treatment is required to the maximum extent practicable (MEP) as determined by the permitting municipality. Exceptions to the stormwater treatment requirement for regulated projects are pervious areas that are “self-treating” (including areas of pervious pavement with a hydraulically-sized aggregate base layer) as described in Section 4.2, and “self-retaining areas” designed to store and infiltrate runoff from rooftops or paved areas as described in Section 4.3.

#### Flow-Based Versus Volume-Based Treatment Measures

For hydraulic sizing purposes, stormwater treatment measures can be divided generally into three groups: flow-based, volume-based, and treatment measures that use a combination of flow and volume capacity. The **flow-based treatment measures** remove pollutants from a moving stream of stormwater through filtration, infiltration or biological processes, and the treatment measures are sized based on hourly or peak flow rates. Examples of flow-based treatment measures include bioretention areas, flow-through planters, media filters and high flow-rate tree well filters. The **volume-based treatment measures** detain stormwater for periods of time to allow treatment through settling and/or infiltration processes or use of stormwater for irrigation or indoor non-potable demands. Examples of volume-based stormwater treatment measures include pervious pavement, infiltration trenches, sub-surface infiltration galleries and rainwater harvesting systems. Flow-through planters and bioretention areas are typically sized using flow-based hydraulic sizing criteria, but in constrained areas they may use a **combination of flow and volume capacity** for stormwater treatment. Table 5-1 shows which hydraulic sizing method is appropriate for commonly used stormwater treatment measures.

---

<sup>17</sup> “Regulated projects” are projects that create and/or replace 5,000 square feet or more of impervious surface and 10,000 square feet or more of impervious surface for large single family homes. See Section 2.3.1 of this Guide for more details.

Table 5-1: Flow and Volume Based Treatment Measure Designs

	Type of Treatment Measure	Type of Hydraulic Sizing Criteria to Use
6.1	Bioretention	Flow-based or combination flow and volume
6.2	Flow-through planter	Flow-based or combination flow and volume
6.3	Tree well filter	Flow-based
6.4	Infiltration trench	Volume-based
6.5	Extended detention basin	Volume-based
6.6	Pervious pavement <sup>18</sup>	Volume-based
6.7	Reinforced grid paving	Volume-based
6.8	Green roof	Volume-based
6.9	Rainwater harvesting	Volume-based
6.10	Media filter	Flow-based
6.11	Subsurface infiltration system	Volume-based

### 5.1.1 Volume-Based Sizing Criteria

The Municipal Regional Stormwater Permit specifies two alternative methods for hydraulically sizing volume-based stormwater treatment measures. One of the permit-approved methods, the “Urban Runoff Quality Management Approach,” is based on simplified procedures that are **not recommended** for use when information is available from continuous hydrologic simulation of runoff using local rainfall records (see “Urban Runoff Quality Management, WEF Manual of Practice No. 23/ASCE Manual and Report on Engineering Practice No. 87.) Because the results of continuous simulation modeling based on local rainfall are available, **the Countywide Program recommends using the “California BMP Handbook Approach,” or “80 percent capture method”**, shown in the text box.

#### Volume-Based Sizing Criteria

Design volume-based treatment measures to treat stormwater runoff equal to the volume of annual runoff required to achieve **80 percent or more capture**, determined in accordance with methodology set forth in Appendix D of the California Stormwater BMP Handbook, using local rainfall data.

The **80 percent capture method** should be used when sizing volume-based treatment measures. The 80 percent runoff value is determined by running a continuous simulation hydrologic model to convert rainfall

<sup>18</sup> In order to be considered self-treating areas or self-retaining areas, as described in Sections 4.2 and 4.3, areas with pervious pavement and reinforced grid paving need to be sized to store and infiltrate/evapotranspire the water quality design volume in the pore space of supporting media.

to runoff based on a long-term local rainfall record<sup>19</sup>. This method for sizing volume-based stormwater treatment measures is described in the California Stormwater Quality Association’s 2003 Stormwater BMP Handbook New Development and Redevelopment, and is the basis for the method described below.

**To size volume-based treatment measures, use the following steps**, which may be performed using the volume-based sizing criteria Excel worksheet referred to in Appendix B.

### 1. Identify Rainfall Region and Site Mean Annual Precipitation (MAP)

Determine which rainfall region the project site is located in using Figure 1 in Appendix C. San Mateo County has been divided into seven different regions based on local rainfall patterns. Use Figure 2 to determine the MAP of the project site.

### 2. Determine the Effective Impervious Area for Each Drainage Management Area

- Based on the topography of the site and configuration of buildings, divide the site into drainage management areas (DMAs), each of which will drain to a treatment measure. Implement the steps below for each DMA with a volume-based treatment measure.
- Minimize the amount of landscaping or pervious pavement that will contribute runoff to the treatment measures. Refer to Sections 4.2 and 4.3 to design areas of landscaping or pervious pavement as “self-treating areas” or “self-retaining areas,” so that they do not contribute runoff to the LID treatment measure and may be excluded from the DMAs for the treatment measures.
- For each DMA in which 5 percent or more of the area that will contribute runoff to the treatment measure includes pervious surfaces (landscaping or properly designed pervious pavement), multiply the area of pervious surface by a factor of 0.1. Then add the product obtained in the previous step to the area of impervious surface, to obtain the “effective impervious area”. For DMAs with less than 5 percent pervious area, use the entire DMA area as the effective impervious area.

### 3. Unit Basin Storage Volume

- Refer to Table 5-2 to determine the **unit basin storage volume** that corresponds to the rainfall region. When using the effective impervious area method, use the unit basin storage volume corresponding to a runoff coefficient of 1.0.
- Adjust the unit basin storage volume to the appropriate value for the project site by applying the following correction factor based on the ratio of the mean annual precipitation (MAP) of the project site to the MAP of the reference rain gage:

$$\text{Correction factor} = \text{MAP}_{\text{site}} \div \text{MAP}_{\text{gage}}$$

For example, if the MAP of the site is 23 inches, and the site is in Region 5 (San Francisco) with a reference gage MAP of 21 inches, the correction factor would be 23/21 inches, or 1.095.

Multiply the unit basin storage volume by the correction factor to get the **adjusted unit basin storage volume**.

- Calculate the **water quality design volume (“C.3.d volume”)** by multiplying the effective impervious area of the drainage management area, determined in step 2, by the adjusted unit basin storage volume (in units of inches converted to feet). For example, if the adjusted unit basin storage volume

<sup>19</sup> The Storage, Treatment, Overflow, Runoff Model (STORM) developed by the U.S. Army Corps of Engineers was used to generate the 80 percent runoff values in this guidance manual.

is determined to be 0.5 inches, and the effective impervious area draining to the bioretention facility is 7,000 square feet. Then the required capture volume would be 0.5 inches × (1 foot/12 inches) × 7,000 square feet = 292 cubic feet.

Table 5-2: Unit Basin Storage Volumes in Inches for 80 Percent Capture Using 48-Hour Drawdown Time

		Unit Basin Storage Volume for Effective Impervious Area of Drainage Management Area
Region <sup>1</sup>	Meteorological Station and Mean Annual Precipitation (Inches)	Coefficient of 1.00
1	Boulder Creek, 55.9"	2.04
2	La Honda, 24.4"	0.86
3	Half Moon Bay, 25.9"	0.82
4	Palo Alto, 14.6"	0.64
5	San Francisco, 21.0"	0.73
6	San Francisco Airport, 20.1"	0.85
7	San Francisco Oceanside, 19.3"	0.72
Source: CDM memo dated May 14, 2004		
<sup>1</sup> See Appendix C to locate the applicable Treatment Measure Design Criteria Region.		

**4. Depth of Infiltration Trench or Pervious Pavement Base Layer**

If designing an infiltration trench, or area of pervious pavement that will receive runoff from impervious surfaces, determine the surface area that is available for the trench, or the area of pervious pavement. Given that surface area, the depth required for the trench or for the aggregate base layer below the pervious pavement (*below the underdrain*), may be calculated by dividing the required capture volume by 0.35 (which represents the assumed void space available within the rock-filled trench or base), and then dividing the rock volume by the surface area of the proposed trench or area of pervious pavement.

**5.1.2 Flow-Based Sizing Criteria**

The Municipal Regional Stormwater Permit specifies three alternative methods for hydraulically sizing flow-based stormwater treatment control measures. These three methods are described in Table 5-3.



Table 5-3: Flow-based Sizing Criteria Included in MRP Provision C.3.d

Flow-based Sizing Criteria	Description	Practice Tips
Percentile Rainfall Intensity	Ranks the hourly depth of rainfall from storms over a long period, determines the 85 <sup>th</sup> percentile hourly rainfall depth, and multiplies this value by two.	This approach requires hydrologic studies that have not been conducted in San Mateo County.
0.2 Inch-per-Hour Intensity <i>(Recommended Method)</i>	Simplification of the Percentile Rainfall Intensity Method: the flow of runoff resulting from a rainfall intensity equal to 0.2 inches/hour	The 4 percent sizing method, which is recommended for use throughout San Mateo County, is derived from this approach.
10% of the 50-year peak flow rate (“Factored Flood Flow Approach”)	Rainfall intensity is determined using Intensity-Duration-Frequency curves published by the local flood control agency or climactic data center.	This approach may be used if the 50-year peak flow has been determined. This approach has not been used locally.

The percentile rainfall intensity method is based on ranking the hourly depth of rainfall from storms over a long period, determining the 85<sup>th</sup> percentile hourly rainfall depth and multiplying by two. For rain gages in the Bay Area at lower elevations, the resulting value is generally around 0.2 inches/hour. The permit also allows the use of 0.2 inches/hour as one of the three alternative methods regardless of the results from calculating values from local rainfall depths.

### Sizing Bioretention Areas

For design of bioretention areas, the 0.2 inches/hour criteria can be simplified to the “4 percent method,” which assumes a runoff inflow of 0.2 inches per hour, and an infiltration rate through Biotreatment Soil Media (BSM) of 5 inches per hour (0.2 in/hr divided by 5 in/hr = 0.04). Because two of the permit-allowed methods yield similar results and the third method requires data that may not be readily available, the **Countywide Program recommends using the 4 percent method to design bioretention areas** and other LID treatment systems that may use flow-based hydraulic sizing criteria.

**Remember**

The Countywide Program **recommends the use of the 4% method** (which is based on a rainfall of 0.2 inches/hour) to hydraulically size bioretention areas in regulated projects.

The 4 percent method requires the surface area of the treatment measure to be 4 percent of the impervious area that drains to it (1,750 square feet of bioretention area per impervious acre). If areas of landscaping or pervious pavement contribute runoff to the treatment measure, the area of these pervious surfaces is multiplied by a factor of 0.1 to obtain the amount of “effective impervious surface” (as described in Section 5.1.1).

*To apply the 4 percent method, use the following steps.*

1. Based on the topography of the site and configuration of buildings, divide the site into drainage management areas (DMAs), each of which will drain to one LID treatment measure. Implement Steps 2 through 5 for each DMA.
2. Minimize the amount of landscaping or pervious pavement that will contribute runoff to the LID treatment measures. Refer to Sections 4.2 and 4.3 to design areas of landscaping or pervious pavement as “self-treating areas” or “self-retaining areas,” so that they do not contribute runoff to the LID treatment measure and may be excluded from the DMAs for the treatment measures.
3. For each DMA in which 5 percent or more of the area that will contribute runoff to the treatment measure consists of pervious surfaces (landscaping or pervious pavement), multiply the area of pervious surface by a factor of 0.1.
4. For applicable DMAs, add the product obtained in Step 3 to the area of impervious surface, to obtain the area of “effective impervious surface.”
5. Multiply the impervious surface (or effective impervious surface in applicable DMAs) by a factor of 0.04. This is the required surface area of the LID treatment measure.

Appendix B includes an example of sizing bioretention areas using the 4 percent method.

### Sizing Other Flow-Based Treatment Measures

Other flow-based stormwater treatment measures, such as media filters (where allowed on a project), are sized using the Rational Method, which computes the runoff resulting from the design rainfall intensity. The Rational Method formula is:

$$Q=CiA$$

Where:

Q= flow in cubic feet/second

C= composite runoff coefficient (unitless – see Table 5-4)

i = rainfall intensity in inches/hour

A= drainage area in acres

To compute the water quality design flow, *use the following steps:*

1. Determine the **runoff coefficient**, “C,” from Table 5-4. Note that it is more accurate to compute an area-weighted “C-factor” based on the surfaces in the drainage area, if possible, than to assume a composite C-factor.
2. Use a design intensity of **0.2 inches/hour** for “i” in the Q=CiA equation.
3. Determine the **drainage area**, “A,” in acres for the stormwater treatment measure.
4. Determine the design flow (Q) using  $Q = CiA$ :  
 $Q = [\text{Step 1}] \times 0.2 \text{ in/hr} \times [\text{Step 3}] = \underline{\hspace{2cm}} \text{ cubic ft/sec}^{20}$

<sup>20</sup> Note that the Rational Method formula produces a result with units of “acre-in/hour”; however, the conversion factor from acre-in/hour to cubic feet/second is approximately 1.0.

Table 5-4: Estimated Runoff Coefficients for Various Surfaces During Small Storms

Type of Surface	Runoff Coefficients “C” factor
Roofs	0.90
Concrete	0.90
Asphalt	0.90
Grouted pavers	0.90
Crushed aggregate	0.90
Pervious concrete	0.10
Pervious asphalt	0.10
Pervious or permeable pavers	0.10
Reinforced grid paving with grass or aggregate surface	0.10
Grass	0.10
Note: These C-factors are only appropriate for small storm treatment design and should not be used for flood control sizing. When available, locally developed small storm C-factors for various surfaces may be used.	

### 5.1.3 Combination Flow and Volume Design Basis

The Countywide Program recommends the use of the 4 percent method for sizing flow-based LID treatment facilities wherever possible, in order to maximize infiltration of treated runoff from these facilities. The 4 percent method, in which the surface area of the treatment measure is designed to be 4 percent of the impervious area that drains to the treatment measure, is conservative in that it does not account for any storage provided in the surface ponding area of the treatment facility.

For projects on sites where infiltration should be avoided, or that are planned to maximize density at redevelopment or infill<sup>21</sup> sites, municipal staff may allow the use of the combination flow and volume design basis for bioretention areas and flow-through planters. In these treatment measures, volume-based treatment is provided when stormwater is stored in the surface ponding area. The surface ponding area may be sized so that the ponding area functions to retain water before it enters the soil at the design surface loading rate of 5 inches per hour required by MRP Provision C.3.c(2)(b)(vi).

<sup>21</sup> For the purpose of selecting hydraulic sizing criteria, this Guide defines infill sites as properties served by existing roadways and other infrastructure, for which all adjacent properties are occupied by existing development or have previously been developed. Redevelopment sites are defined as properties occupied by existing development that will be removed, or partially removed, to construct the proposed project. Individual municipalities may have stricter definitions for the purpose of selecting hydraulic sizing criteria.

Provision C.3.d of the MRP specifies that treatment measures that use a combination of flow and volume capacity shall be sized to treat at least 80 percent of the total runoff over the life of the project, using local rainfall data. This sizing approach is best applied when using a continuous simulation hydrologic model to demonstrate that a treatment system is in compliance with C.3.d. However, when doing sizing calculations by hand, compliance with C.3.d. can be demonstrated by showing how the treatment system design meets both the flow-based and volume-based criteria.

Where allowed by the municipality, lined bioretention areas and flow-through planters in locations where infiltration should be avoided or on redevelopment or infill sites (as defined above) may use the approach described below to take into consideration both the flow of stormwater through the planting media and the volume of stormwater in the surface ponding area. This approach will allow for a reduction in the surface area of the treatment measure, which may be appropriate for projects that are planned to maximize density at redevelopment or infill sites, and therefore offer environmental benefits such as reduced disturbance of previously undeveloped land and reduced vehicle miles traveled, when compared with comparable development projects in areas with little or no prior development.

***To apply the combination flow and volume approach, use the following steps***, which may be performed using the combination flow and volume sizing criteria Excel worksheet referred to in Appendix B. Note the first three steps below are the same as the first three steps to size volume-based treatment measures on page 48.

### **1. Identify Rainfall Region and Site Mean Annual Precipitation (MAP)**

- Determine which rainfall region the project site is located in using Figure 1 in Appendix C. San Mateo County has been divided into seven different regions based on local rainfall patterns. Use Figure 2 to determine the MAP of the project site.

### **2. Determine the Effective Impervious Area for Each Drainage Management Area**

- Based on the topography of the site and configuration of buildings, divide the site into drainage management areas (DMAs), each of which will drain to a treatment measure. Implement the steps below for each DMA with a volume-based treatment measure.
- Minimize the amount of landscaping or pervious pavement that will contribute runoff to the treatment measures. Refer to Sections 4.2 and 4.3 to design areas of landscaping or pervious pavement as “self-treating areas” or “self-retaining areas,” so that they do not contribute runoff to the LID treatment measure and may be excluded from the DMAs for the treatment measures.
- For each DMA in which 5 percent or more of the area that will contribute runoff to the treatment measure includes pervious surfaces (landscaping or properly designed pervious pavement), multiply the area of pervious surface by a factor of 0.1. Then add the product obtained in the previous step to the area of impervious surface, to obtain the “effective impervious area”. For DMAs with less than 5 percent pervious area, use the entire DMA area as the effective impervious area.

### **3. Unit Basin Storage Volume**

- Determine the ***unit basin storage volume*** from Table 5-2 based on the composite effective impervious area runoff coefficient of 1.0 and the rain gauge area.

- Adjust the unit basin storage volume to the appropriate value for the project site by applying the following correction factor based on the ratio of the mean annual precipitation (MAP) of the project site to the MAP of the reference rain gage:

$$\text{Correction factor} = \text{MAP}_{\text{site}} \div \text{MAP}_{\text{gage}}$$

For example, if the MAP of the site is 23 inches, and the site is in Region 5 (San Francisco) with a reference gage MAP of 21 inches, the correction factor would be 23/21 inches, or 1.095.

Multiply the unit basin storage volume by the correction factor to get the adjusted unit basin storage volume.

- Calculate the **water quality design volume (“C.3.d volume”)** by multiplying the effective impervious area of the DMA, calculated in step 2, by the adjusted unit basin storage volume (in units of inches converted to feet). For example, if the adjusted unit basin storage volume is determined to be 0.5 inches, and the effective impervious area draining to the bioretention facility is 7,000 square feet. Then the required capture volume would be 0.5 inches × (1 foot/12 inches) × 7,000 square feet = 292 cubic feet.

#### 4. Estimate the Duration of the Rain Event

- Assume that the rain event that generates the required design volume of runoff determined in Step 3 occurs at a constant rainfall intensity of 0.2 inches/hour from the start of the storm (i.e., assume a rectangular hydrograph). Calculate the **duration of the rain event** by dividing the adjusted unit basin storage volume by the intensity. In other words, determine the amount of time required for the unit basin storage volume to be achieved at a rate of 0.2 inches/hour. For example, if the unit basin storage volume is 0.5 inches, the rain event duration is 0.5 inches ÷ 0.2 inches/hour = 2.5 hours.

#### 5. Make a Preliminary Estimate of the Surface Area of the Facility

- Make a **preliminary estimate of the surface area** of the bioretention facility by multiplying the DMA’s area of impervious surface (or equivalent impervious surface from step 4, if applicable) by the 4 percent method sizing factor of 0.04. For example, a drainage area of 7,000 square feet of impervious surface × 0.04 = 280 square feet of bioretention treatment area.
- Assume a bioretention area that is about 25% smaller than the bioretention area calculated with the 4 percent standard. Using the example above, 280 – (0.25 × 280) = 210 square feet.
- Calculate the volume of runoff that filters through the treatment soil** at a rate of 5 inches per hour (the design surface loading rate for bioretention facilities), for the duration of the rain event calculated in Step 5. For example, for a bioretention surface area of 210 square feet, with an infiltration rate of 5 inches per hour for a duration of 2.5 hours, the volume of treated runoff = 210 square feet × 5 inches/hour × (1 foot/12 inches) × 2.5 hours = 219 cubic feet.

#### 6. Initial Adjustment of Depth of Surface Ponding Area

- Calculate the portion of the water quality design volume **remaining after treatment is accomplished by filtering** through the treatment soil. The result is the amount that must be stored in the ponding area above the reduced bioretention area assumed in Step 6. For example, the amount remaining to be stored comparing Step 6 and Step 9 is 292 cubic feet – 219 cubic feet = 73 cubic feet. If this volume is stored over a surface area of 210 square feet, the average ponding depth would be 73 cubic feet ÷ 210 square feet = 0.35 feet or 4.2 inches.

- Check to see if the *average ponding depth is approximately 6 inches (or up to a maximum of 12 inches if allowed by the municipality)*, which is the recommended ponding depth in a bioretention facility or flow-through planter.

### 7. Optimize the Size of the Treatment Measure

- If the ponding depth is less than 6 inches, the bioretention design can be optimized with a smaller surface area (i.e., repeat Steps 6 and 7 with a smaller area). If the ponding depth is greater than 6 inches (or the depth allowed by the municipality), a larger surface area will be required. (In the above example, the recommended size of the bioretention area is 190 square feet with a ponding depth of 6 inches.)

Appendix B includes an example of sizing bioretention areas using the combination flow and volume-based method. C.3 Sizing Worksheets to assist project design teams, are available on the Flowstobay website. Go to the [C.3 Regulated Projects webpage](#) and then scroll down to the section for “Forms and Checklists”.

## 5.2 Applicability of Non-Low Impact Development (LID) Treatment Measures

Since December 1, 2011, the MRP has placed **restrictions on the use of non-LID treatment measures**. However, per Provision C.3.e, Special Projects may be allowed some limited use of two types of non-LID treatment measures for stand-alone treatment of stormwater - vault-based media filters and high flow rate tree well filters – if allowed by the municipality. As further discussed in Appendix J of this Guide, Special Projects that meet certain criteria are allowed to treat specified percentages of the C.3.d amount of stormwater runoff with these non-LID treatment measures. Alternatively, the municipality may choose to require 100% LID treatment of all on-site runoff and disregard the options in C.3.e. See Appendix J for additional guidance on Special Projects.

### Key Point

Since December 1, 2011, there have been restrictions on the use of non-LID treatment measures.

Underground vault-based, non-LID treatment measures typically require frequent maintenance to function properly, and experience has shown that because these systems tend to be “out of sight, out of mind,” they often do not receive adequate maintenance. Where underground vaults are allowed, they must be sealed to prevent mosquito access, or be designed to completely drain or have no standing water for longer than 72 hours, and include suitable access doors and hatches to allow for frequent inspections and maintenance. See Appendix D for more information regarding non-LID treatment measures.

The GI Design Guide has additional information on the use and maintenance of non-LID measures and alternative GI measures. See Chapter 2 for design information and Chapter 6 for maintenance information of non-LID measures such as media filters, tree well filters with high-flow rate media and underground trash capture device vaults as well as alternative GI measures such as vegetated swales, stormwater trees and green gutters.

### 5.3 Using Manufactured Treatment Measures

In the limited cases (Special Projects) where a municipality does approve the use of one or more manufactured treatment measures in a development project, the project applicant is responsible for installing the unit(s) so that they will function as designed and for following the manufacturer's instructions for maintenance. When installed and maintained properly, manufactured media filters (see Section 6.10) may have adequate pollutant removal levels for fine particles and their attached pollutants. Media filters typically include two chambers: the first chamber allows coarse solids to settle, and the second contains the filters that consist of a proprietary media. When installed and maintained properly, hydrodynamic separators may be effective in removing trash and coarse sediment, but not dissolved pollutants, and they may be installed upstream of other treatment measures.

The **applicant is responsible** for ensuring that the manufactured treatment measures used in the project are sized in accordance with the Provision C.3.d hydraulic sizing criteria to treat the amount of runoff that will flow to these treatment measures. The surface loading rate of the media filter should be based on the Washington State TAPE approved rate (see Section 6.10).

**Planning permit submittals** should include a description of the product(s) proposed for use, along with preliminary sizing calculations, and conceptual plans showing the proposed locations of treatment measures on the site. **Building permit submittals** should include detailed sizing calculations, construction-level drawings, and a copy of the manufacturer's instructions for construction and maintenance. Maintenance plans for manufactured treatment measures must follow the manufacturer's maintenance instructions.



## 5.4 Using Treatment Trains

Stormwater can be directed to flow through a series of different types of stormwater treatment measures that are each designed to treat different broad categories of stormwater pollutants. These groupings of stormwater treatment measures have been called “stormwater treatment trains” or a “multiple treatment system.” The use of a **series of treatment measures** is most effective where each treatment measure optimizes the removal of a particular type of pollutant, such as coarse solids and debris, pollutants associated with fine solids, and dissolved pollutants. Targeting specific treatment processes by constituent is referred to as “unit process” design. **Each stormwater treatment measure in a treatment train should be sized using the appropriate Provision C.3 numeric sizing criteria.**

The simplest version and most common use of a treatment train consists of **pretreatment** prior to the stormwater reaching the main treatment system. For example, a hydrodynamic separator can be used to remove trash and coarse sediment upstream of a media filter or subsurface infiltration system. **Note that non-LID treatment measures may be used in the treatment train as long as the last measure in the train is a LID treatment measure.**

Another option for a treatment train is to provide upstream storage for a treatment measure which may allow the treatment measure to be reduced in size. For example, a rainwater cistern may be used to store and slowly release water to a bioretention facility. Conversely, the bioretention facility can be used to treat the overflow from the cistern if there is insufficient irrigation or toilet flushing demand to empty the cistern prior to the next rain event.

### Key Point

#### What Is A Treatment Train?

A treatment train is a multiple treatment system that uses two or more stormwater **treatment measures in series**, for example, a settling basin/ infiltration trench combination

## 5.5 Infiltration Guidelines

Infiltration is a preferred LID treatment measure and a cost-effective method to manage stormwater – if the conditions on the site allow. A wide-range of site-design measures and stormwater treatment measures can be used to increase stormwater infiltration and can be categorized as follows.

- **Site design measures** -- such as clustering development or otherwise laying out the site to reduce impervious area, routing drainage from building roofs to landscaped areas, and using pervious pavement.
- **Indirect infiltration** methods, which allow stormwater runoff to percolate **into surface soils**. Runoff may reach groundwater indirectly, or it may be underdrained into subsurface pipes. Examples of indirect infiltration methods include bioretention areas and shallow infiltration trenches or basins. Unless geotechnical considerations preclude it, all projects should maximize infiltration of stormwater runoff through methods such as bioretention (see Section 6.1).
- **Direct infiltration** methods, which are designed to **bypass surface soils** and transmit runoff directly to subsurface soils for groundwater recharge. These types of devices must be located and designed to limit the potential for stormwater pollutants to reach groundwater. Examples of direct infiltration methods include deep infiltration trenches and dry wells. Direct infiltration systems are regulated by the EPA (Class V well certification) and pretreatment is required. Direct infiltration measures may also require coordination with local groundwater purveyors and/or public health agencies. In San Mateo County, contact the Groundwater Protection Program of the County Health Department<sup>22</sup>.

The local jurisdiction may require a geotechnical review for the project, or, at a minimum, information regarding the site’s hydrologic soil type. When selecting site design and stormwater treatment measures that promote on-site infiltration, be sure to **follow the geotechnical engineer’s recommendations** based on soil boring data, drainage pattern, and the current requirements for stormwater treatment. The geotechnical engineer’s input will be essential to prevent damage from infiltrated water to surrounding properties, structures and/or public improvements.

### Warning

Follow the geotechnical engineer’s recommendations for infiltration-based treatment measures to prevent any damage to surrounding properties.

Appendix E provides guidelines to help determine whether the project site is suitable for using site design and/or stormwater treatment measures that increase stormwater infiltration. Appendix E also describes regulatory requirements that apply to direct infiltration methods, as well as practical tips for design and construction.

<sup>22</sup> For more information, go to [www.smchealth.org/gpp](http://www.smchealth.org/gpp).

## 5.6 Bypassing High Flows

Although stormwater treatment measures are sized to remove pollutants from flows resulting from frequent, small storms, projects must be designed to handle flows for stormwater treatment and drainage from large infrequent flows to **prevent flooding**. The integration of flood control and stormwater treatment may be accomplished in one of two ways, which are described below.

One option is to have the flows that are larger than those required by the hydraulic sizing criteria (given in Section 5.1) handled **within the stormwater treatment measure**. This includes making sure that landscape-based treatment measures do not re-suspend and flush out pollutants that have been accumulating during small storms, and that landscape-based stormwater treatment measures do not erode during flows that will be experienced during larger storms. Most extended detention basins are designed to handle flood flows, although they would not be providing much treatment during these flows. The technical guidance in Chapter 6 for treatment measures that operate in this manner includes design standards to accommodate flood flows associated with larger storms.

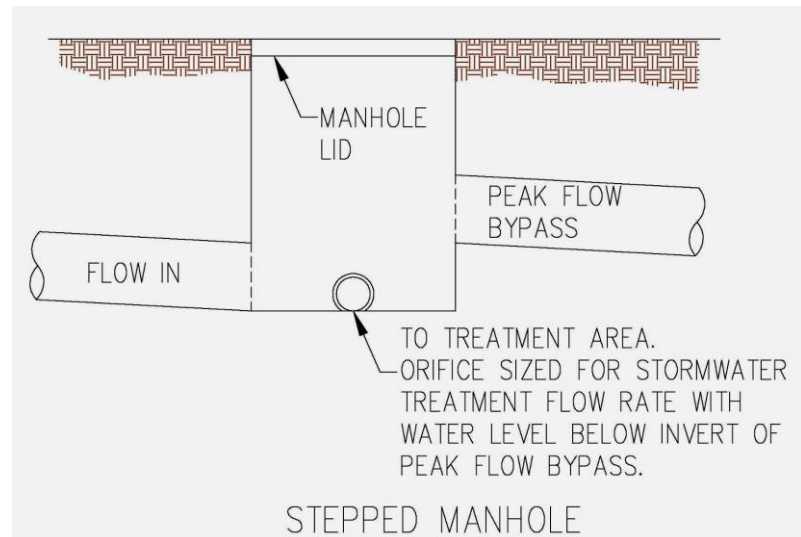


Figure 5-1: Stepped manhole design directs low flows to treatment measure and diverts high flows to storm drain system. (Credit: BKF Engineers)

Bioretention areas, flow-through planter boxes, and other treatment systems that rely on filtering or infiltrating stormwater through soils must have overflow systems that allow flood flows larger than the increment of flow that can be treated to bypass the stormwater treatment measure. These systems have to include an alternative flow path for high flows, otherwise stormwater would back up and flood the project area. The technical guidance in Chapter 6 for treatment measures that operate in this manner includes design standards for high-flow bypasses.

## 5.6 Bypassing High Flows

For some types of stormwater treatment measures that are designed as low-flow systems, it is often necessary to restrict stormwater flows and **bypass the flows around the facility**. In these instances the stormwater treatment measures are designed to treat only the water from small storm events. Bypassing larger flows helps prevent hydraulic overload and resuspension of sediment, and it can protect stormwater treatment measures from erosion.

**Flow splitter devices** may be used to direct the design runoff flow into a stormwater treatment measure, and bypass excess flows from larger storm events around the facility into a bypass pipe or channel. The bypass may connect directly to the storm drain system, or to another stormwater treatment measure that designed to handle high flows. This can be accomplished using a stepped manhole (Figure 5-1), a vault or box with a weir (Figures 5-3 and 5-4) or a proprietary flow splitter. As illustrated in Figure 5-2, runoff enters the device by way of the inlet at the left side of the figure; low flows are conveyed to the stormwater treatment measure by way of the outlet pipe at the lower right. Once the treatment measure reaches its design capacity, water backs up in the low-flow outlet pipe and into the flow splitter. When the water level in the flow splitter reaches the bypass elevation, stormwater begins to flow out the overflow pipe in the upper right of the figure, bypassing the stormwater treatment measure. The bypass generally functions by means of a weir inside the flow splitter device.



Figure 5-2: StormGate™ proprietary flow splitter structure. (Credit: Contech Construction Products Inc). The use of this illustration is for general information only and is not an endorsement of this or any other proprietary device.



Figure 5-3: Details of flow splitter boxes - *Left*: Flow splitter vault with weir  
*Right*: Flow splitter box with weir (Credit: EOA Inc)

## 5.7 Plant Selection and Maintenance

Selecting the appropriate plants and using sustainable, horticulturally sound landscape installation and maintenance practices are essential components of a successful landscape-based stormwater treatment measure. *See Section 4.11 and Chapter 6 of the GI Design Guide for additional guidance on these topics.*

### Plant Selection Guidance

Plant selection must consider the type of development and location, uses on the site and an appropriate design aesthetic. Ideally, a Landscape Architect will be involved as an active member of the design team **early in the site design phase** to review proposed stormwater measures and coordinate development of an integrated solution that responds to all of the various site goals and constraints. In some cases, one professional will design a stormwater control, while another designs the rest of the landscaping. In these situations it is essential for the professionals to work together very early in the process to integrate their designs. Appendix A provides user-friendly guidance in selecting planting appropriate to the landscape-based stormwater treatment measures included in Chapter 6 and the site design measures in Chapter 4.

This plant guidance applies to systems designed to retain up to 6" of runoff. When deeper systems are used, have the plant selection verified by a landscape architect. Developers and design teams can also select plant materials outside of the list in Appendix A, but should consult with a landscape architect or horticulturalist, and may require approval from the municipality.

### Bay-Friendly Landscaping (ReScape<sup>23</sup>)

Bay-Friendly Landscaping is a holistic approach to the **design, construction and maintenance** of landscapes in order to support the integrity and sustainability of the local watershed. Project sponsors are encouraged to use landscape professionals who are familiar with and committed to implementing Bay-Friendly (and Ocean-Friendly) Landscaping practices from the initial plant selection through the long-term maintenance of the site. Rescape Qualified Professionals receive training on Bay-Friendly principles and practices and certification from ReScape. Appendix A summarizes Bay-Friendly Landscaping practices that may be implemented to benefit the water quality of the Bay, Ocean and their tributaries, based on the Bay-Friendly Landscaping Guidelines. ReScape's eight principles for regenerative landscapes are shown in Figure 5-5.



Figure 5-4: ReScape Principles (Credit: ReScape)

<sup>23</sup> The Bay-Friendly Landscaping Coalition is now known as ReScape ([www.rescapeca.org](http://www.rescapeca.org)).

### Integrated Pest Management

Integrated pest management (IPM) is a holistic approach to mitigating insects, plant diseases, weeds, and other pests. Projects that require a landscaping plan as part of a development project application are encouraged to use IPM, as indicated in each agency's source control measures list. **Avoiding pesticides and quick release synthetic fertilizers** is particularly important when maintaining stormwater treatment measures to protect water quality. IPM is one aspect of the Bay-Friendly Landscaping program.

IPM encourages the use of many strategies for first preventing, and then controlling, but not eliminating, pests. It places a priority on fostering a healthy environment in which plants have the strength to resist diseases and insect infestations, and out-compete weeds. Using IPM requires an understanding of the life cycles of pests and beneficial organisms, as well as regular monitoring of their populations. When pest problems are identified, IPM considers all viable solutions and uses a combination of strategies to control pests, rather than relying on pesticides alone. As a last resort pesticides with low levels of toxicity may be used. More information on IPM is included in Appendix A.



*Figure 5-5: Beneficial insects can help control pests.*

#### Warning

Avoid pesticides and synthetic fertilizers to protect water quality.

### Wetland Regulations and Treatment Measures

The Water Board's "Policy on the Use of Constructed Wetlands for Urban Runoff Pollution Control" (Resolution No. 94-102) recognizes that stormwater treatment wetlands that are constructed and operated pursuant to Resolution 94-102 and are constructed outside a creek or other receiving water are stormwater treatment systems, and, as such, are not waters of the United States subject to Sections 401 and 404 of the federal Clean Water Act.

### Water Efficient Landscaping Requirements

The California Water Conservation in Landscaping Act of 2006 requires municipalities to adopt, by January 1, 2010, landscape water conservation ordinances that are at least as effective with regard to water conservation as the [Model Water Efficient Landscape Ordinance \(MWELO\)](#) prepared by the Department of Water Resources (DWR). The MWELO automatically went into effect, on January 1, 2010, in municipalities that have not adopted a local Water Efficient Landscape Ordinance (WELo).

The California Water Commission approved the revised MWELO on July 15, 2015. The deadline for local agencies to adopt the MWELO or adopt their own WELo, which must be at least as effective in conserving water, was December 1, 2015. The deadline for local agencies creating a regional ordinance was February 1, 2016. The MWELO may be updated again in 2024.

**Most new and rehabilitated landscapes** are subject to a WELo. The MWELO applies to the following public and private development projects:

1. New construction projects with an aggregate landscape area equal to or greater than 500 square feet requiring a building or landscape permit, plan check or design review; or
2. Rehabilitated landscape projects with an aggregate landscape area equal to or greater than 2,500 square feet requiring a building or landscape permit, plan check, or design review.

The municipality will **determine whether the project is subject to the MWELO** or a comparable local WELo.

## 5.8 Mosquito Control

Some types of stormwater treatment measures are designed to hold water, and even treatment measures that are designed to eliminate standing water between storms have the potential to **retain standing water** if they are not properly designed, constructed and maintained.

The Countywide Program developed a Vector Control Plan to help reduce the potential for stormwater treatment measures to breed mosquitoes. The Vector Control Plan describes the need to include physical access for mosquito control staff to monitor and treat mosquitoes, and it includes guidance for designing and maintaining stormwater treatment measures to control mosquitoes. The San Mateo County Mosquito Abatement District staff has identified a **five-day maximum** allowable water retention time, based on actual incubation periods of mosquito species in this area. With the exception of certain stormwater treatment measures that are designed to hold water permanently (e.g., CDS units and wet ponds), all treatment measures should drain completely within five days to prevent mosquito breeding. *Please note that the design of LID treatment measures does not require that water be standing for five days*, even though this is allowable for vector control. Pervious pavement and infiltration trenches are typically designed to drain within 48-72 hours, and properly designed bioretention systems should drain within a few hours.

Treatment measure designs and maintenance plans must include mosquito control **design and maintenance strategies** from the countywide Vector Control Plan, which are included in Appendix F. Project plans that include stormwater treatment measures (and their maintenance plans) may be routed to the San Mateo County Mosquito Abatement District for review. Project applicants may wish to consult with Mosquito Abatement District staff for guidance.

### Key Point

Treatment measure designs and maintenance plans must **include mosquito control design and maintenance strategies** from the Vector Control Plan, which are included in Appendix F.

## 5.9 Incorporating Treatment with Hydromodification Management

In addition to the requirement to treat stormwater runoff to remove pollutants, the MRP also requires that stormwater runoff be detained and released in a way that **prevents increased creek channel erosion** and siltation. The amount of stormwater flow and the duration of the flow must be limited to match what occurred prior to the currently proposed development or re-development. These hydromodification management (HM) requirements apply to projects that create one acre or more of impervious surface in certain areas of San Mateo County (see Chapter 7).

The HM requirements have been in effect since 2007 and may be required on the project in addition to stormwater treatment, low impact development, and flood control requirements (if any). To prevent hydromodification, HM facilities are designed to match post-project flow durations to pre-project durations **for a range of 10 percent of the two-year peak flow up to the ten-year peak flow**. This is different from the sizing criteria that are used for stormwater treatment measures and the design criteria used for flood control facilities. Implementing low impact development site design and treatment measures in the project may help to reduce the size of required HM facilities.



*Figure 5-6: Detention pond used for hydromodification management.*

To help applicants meet the HM requirements, the Countywide Program developed the Bay Area Hydrology Model (BAHM) with assistance from the municipal stormwater programs in Santa Clara and Alameda Counties. The BAHM can be used to **automatically size stormwater detention measures** such as detention vaults, tanks, basins and ponds for Flow Duration Control of post-project runoff. The BAHM takes into consideration the implementation of low impact development site design and treatment measures when calculating the required size of HM facilities. Chapter 7 provides more detail on HM requirements and the BAHM.



### 5.10 Treatment Measures in Areas of Bay Fill

Extensive portions of San Mateo County's bayside consist of historic Bay wetlands that were filled long ago to accommodate development pressure. These areas typically have **high water tables**, and the fill soils have a tendency to settle. Both of these characteristics can lead to problems with building foundations. Treatment measures that rely on direct infiltration to treat stormwater, such as infiltration trenches, are inappropriate to use on properties with a high-water table. Be sure to consult the **infiltration guidance in Appendix E** when considering a stormwater treatment measure that relies on infiltration to treat stormwater for the site.

Sites with contaminated soils and/or groundwater may want to consider flow through planters, green roofs, media filters, tree well filters and other systems that can be located above grade and can be fully contained to prevent infiltration and conflicts with brownfield and/or site cleanup containment/protection systems. California Geotracker<sup>24</sup>, the SF-based non-profit Center for Creative Land Recycling<sup>25</sup>, EPA Region 9<sup>26</sup> and the California Department of Toxic Substances Control<sup>27</sup> all have information on brownfields and contaminated site remediation.

#### Warning

Some areas of San Mateo County are not suitable for treatment measures that rely on infiltration. Consult the infiltration guidance in Appendix E for more information.

---

<sup>24</sup> <https://geotracker.waterboards.ca.gov/>

<sup>25</sup> <https://www.cclr.org/>

<sup>26</sup> <https://www.epa.gov/brownfields/brownfields-and-land-revitalization-california-arizona-nevada-and-hawaii>

<sup>27</sup> <https://dtsc.ca.gov/brownfields/>

## 5.11 Treatment Measures in Seismic Hazard Areas

The San Andreas Fault passes through the county near the Skyline Boulevard and I-280 corridors areas before exiting the coast at Mussel Rock Park in Daly City. State law prohibits the location of developments and habitable structures across the trace of active faults and limits the placement of these types of structures to no less than 50 feet of an active fault trace. Projects located near a fault typically need to incorporate special design features. For example, **pipes built across a fault** need to accommodate the gradual movement of the tectonic plates that meet at the fault line. If the project is located near a fault line, **the local jurisdiction should be contacted** to obtain any special requirements for storm drain pipes or other stormwater facilities included in the project.

### Contact

Contact the local jurisdiction for recommendations on projects located near a fault line.

Steep slopes and areas of Bay fill may also be identified as seismic hazard areas, based on the damage to buildings, bridges, and other structures that may occur in these areas during a major earthquake. To date, stormwater professionals have not identified seismic-induced failure as a threat to stormwater treatment measures located in Bay fill areas or on steep slopes. There are, however, special concerns associated with stormwater treatment measures that rely on infiltration in areas with high water tables or steep slopes. These concerns are addressed in **Appendix E**.

## 5.12 Artificial Turf and Stormwater Treatment

Artificial turf typically consists of a permeable synthetic grass layer over a permeable underlay, such as gravel, and a compacted sub-base, with a subdrain to collect water and convey it to the storm drain system. Artificial turf can be designed to allow infiltration of runoff to the underlying soils.

When reviewing plans for artificial turf, here are two items to check:

1. When calculating the total area of a project's new and/or replaced impervious surface, areas of artificial turf are considered pervious, if the underdrain is placed sufficiently high in the gravel base layer, so that the void space in the gravel below the underdrain is sufficient to store and infiltrate the amount of stormwater specified in Provision C.3.d of the MRP (see Figures 5-25 and 5-26 for more details).

2. If crumb rubber is used in artificial turf applications, precautions must be taken to avoid discharging the rubber pieces into storm drains and adjacent water bodies. Figure 5-7 below shows the accumulation of crumb rubber in a bioretention area treating runoff from an artificial turf sports field in Berkeley.

Although using artificial turf in place of natural turf can help conserve water and reduce pesticide and fertilizer use, it is advisable to ***weigh the benefits against potential environmental impacts***, such as the heating effect of artificial turf (as opposed to the cooling effect of natural turf). Many athletes prefer natural turf to synthetic because of the damage that can occur to joints over time and the potential to negatively impact health over time<sup>28</sup>. Concerns have also been raised regarding the potential for toxic chemicals in artificial turf to pollute stormwater; however, data on this issue are limited and inconclusive to date.



Figure 5-7: This bioretention area treats runoff from an artificial turf field in Berkeley and has an accumulation of crumb rubber particles (the black areas in the photo). (Credit: EOA, Inc.)

<sup>28</sup> [www.epa.gov/chemical-research/federal-research-recycled-tire-crumb-used-playing-fields](http://www.epa.gov/chemical-research/federal-research-recycled-tire-crumb-used-playing-fields)

## 5.13 Getting Water into Treatment Measures

Getting water into treatment measures is a key challenge for designers. In the Bay Area over the last 20 years many designs have failed to achieve this crucial treatment measure element. The design flaws can be categorized into three areas: entry grading/slope, blockage and widths. Examples of each problem and better designs are shown in Figure 5-8. *Sections 4.7 and 4.8 of the GI Design Guide contain additional guidance on how to capture and convey surface and roof runoff in Green Street and other projects.*



Figure 5-8 – Examples of common design problems with inlets of treatment measures.  
(Credit: EOA, Inc. and City of Mountain View)

The types of inlets for LID measures include: *flush curb (sheet flow), roof leaders (downspouts), bubble up emitters, trench drains, or curb cuts (green street inlets may have special design, construction and maintenance considerations – see Chapters 3 and 4 of the GI Design Guide for more information)*. Once the water is in the system, erosion is the next challenge. To avoid erosion, cobbles or other energy dissipaters can be used. An example of a well-designed trench drain inlet into a flow-through planter with a concrete splash apron and grouted cobbles for energy dissipation is shown below in Figure 5-9. A minimum two-inch drop in grade between the impervious surface and the finish grade of the stormwater treatment facility is recommended. This drop in grade needs to take into consideration the height of any vegetation.



*Figure 5-9: A concrete splash apron (with grouted cobble) is placed at the inlet to this stormwater treatment measure in Berkeley to help prevent erosion. Additional loose cobble is placed on the edges to prevent erosion. Other measures, such as using pea gravel or locating plants closer to the apron, could be used and would entail fewer maintenance issues than loose large cobble. (Credit: EOA, Inc.)*



*Figure 5-10: Another design option is to use vertical elements such as plants or concrete blocks at the inlet to dissipate energy and reduce erosion. This drain in a park in Denver has a large diameter pipe so more heavy-duty measures were required to manage the strength of the high-volume flows expected, but maintenance of the system is easier than with large rock such as cobble. (Credit EOA, Inc.)*

### Standard Curb Cut: Design Guidance

- Opening should be at least 18 inches wide; for smaller facilities 12" width may be allowed at more frequent intervals subject to municipal approval.
- Curb cut should have angled sides at 45 degrees (as shown in Figures 5-11 and 5-12).
- Curb walls at the cut can also be chamfered to reduce damage to wheels and aid runoff in entering the inlet. (Not shown).
- Curb cuts work well with relatively shallow stormwater facilities that do not have steep side slope conditions.
- Slope the bottom of the concrete curb toward the stormwater facility (a depressed throat opening).
- The number and location of curb cuts will vary depending on the system design, flow and location.
- Allow a drop in elevation of 4 to 6 inches from the rim of the inner edge of the inlet to the surface of Biotreatment Soil Media (BSM) elevation. This provides for a two inch drop to the top of a splash apron or mulch so that vegetation does not obstruct flow.



Figure 5-11: This standard curb cut in San Francisco has angled sides, a depressed throat and a 2-inch drop off to a splash apron. (Credit: EOA, Inc.)

- Provide a splash apron, grouted cobble, pea gravel, plants and mulch or other energy dissipater to prevent erosion. Loose cobble is not recommended due to maintenance and weed issues.

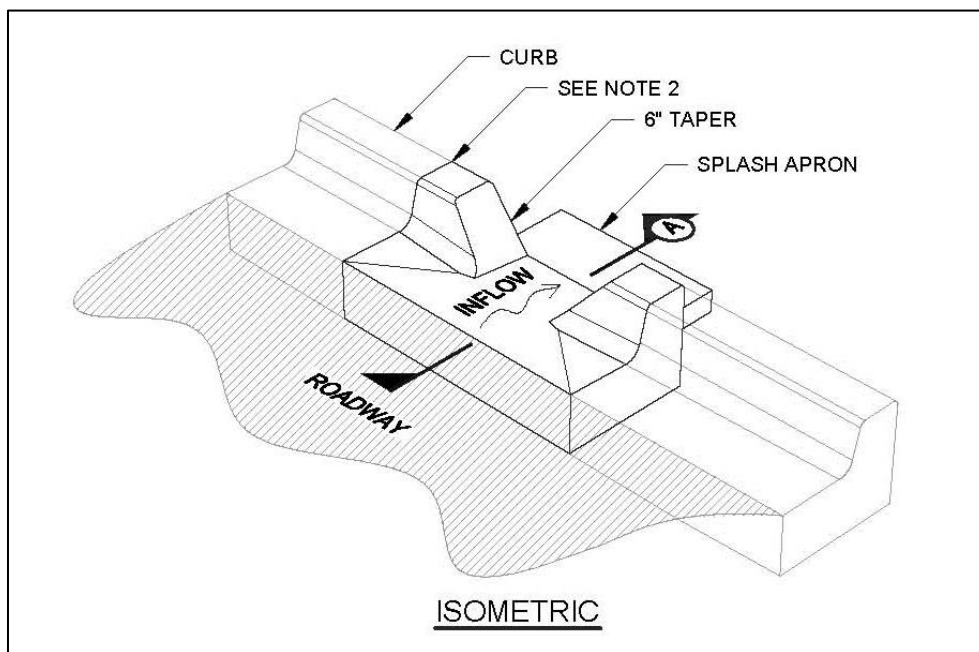


Figure 5-12: Standard curb cut: isometric view (Credit: SMCWPPP and SFPUC, 2019)

### Standard Curb Cut with Side Wings: Design Guidance

- Openings should be at least 18 inches wide; for smaller facilities 12" width may be allowed subject to municipal approval. Narrow curb cuts or trench drains can work if the outlet is wide and protected (see Figure 5-13).
- Works well with stormwater facilities that have steeper side slope conditions.
- Need to slope the bottom of the concrete curb toward the stormwater facility.
- Allow a change in elevation of 4 to 6 inches between the paved surface and BSM elevation, so that vegetation or mulch build-up does not obstruct flow. Provide a 2" drop from the inlet to the splash apron or energy dissipator.
- Provide a splash apron, grouted cobble, pea gravel, plants, mulch or other energy dissipater to prevent erosion. Loose cobble is not recommended due to maintenance and weed issues.



Figure 5-13: The side wings and concrete apron of this trench drain curb cut prevent blockage & erosion. (Credit EOA, Inc.)

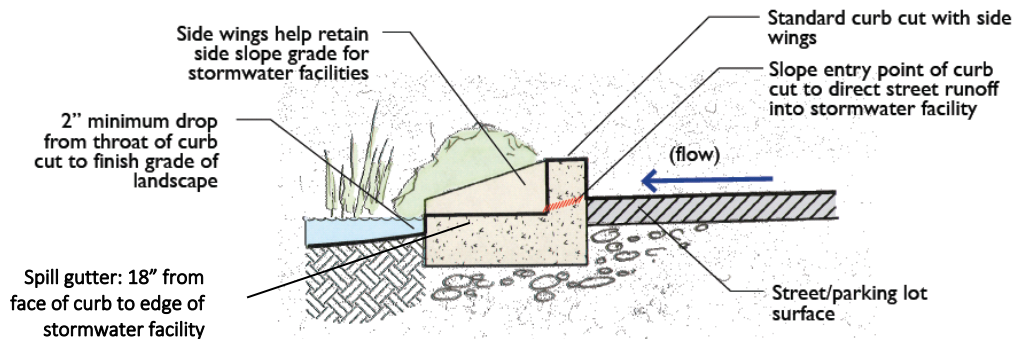


Figure 5-14: Standard curb cut with side wings: cut section view (Source: SMCWPPP, 2009)

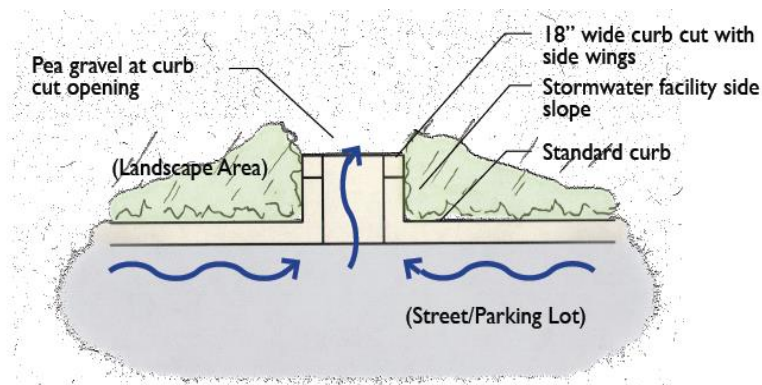


Figure 5-15: Standard curb cut with side wings: plan view (Source: SMCWPPP, 2009)

### Wheelstop Curbs: Design Guidance

- Wheelstops allow water to flow through frequently spaced openings.
- Wheelstops are most common in parking lot applications, but they may also be applied to certain street conditions.
- Need to provide a minimum of 6 inches of space between the wheelstop edge and edge of paving. This is to provide structural support for the wheelstop.
- Allow a change in elevation of 4 to 6 inches between the paved surface and BSM elevation, so that vegetation or mulch build-up does not obstruct flow (see Figure 5-16).
- Provide a splash apron, grouted cobble, pea gravel, plants, mulch or other energy dissipater to prevent erosion. Loose cobble is not recommended due to maintenance and weed issues.



Figure 5-16: Stormwater runoff enters the stormwater facility through the 3-foot space between these wheelstops. The design could be improved by providing more drop in grade between the asphalt and landscape area. (Credit: SMCWPPP, 2009)

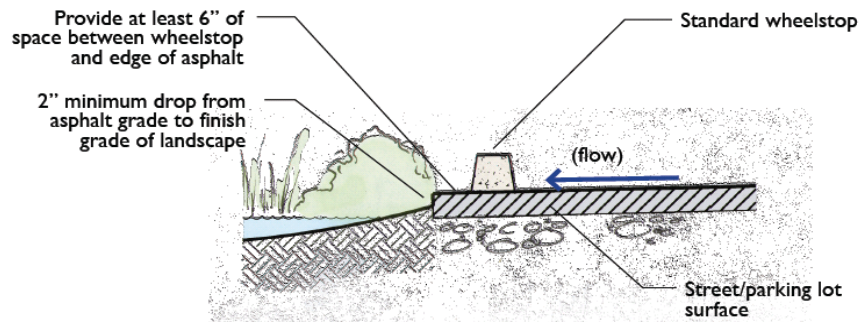


Figure 5-17: Opening between wheelstop curbs: section view (Source: SMCWPPP, 2009)

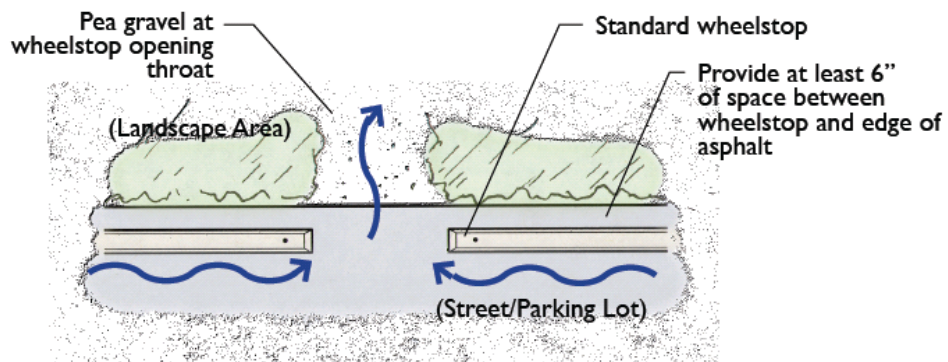


Figure 5-18: Opening between wheelstop curbs: plan view (Source: SMCWPPP, 2009)



### Grated Curb Cut: Design Guidance

- Grated curb cuts allow stormwater to be conveyed under a pedestrian walkway. The curb cut opening should be at least 18 inches wide; 12" may be allowed for smaller facilities subject to municipal approval.
- Grates need to be ADA compliant and have sufficient slip resistance.
- A 1- to 2-inch-high asphalt or concrete berm should be placed on the downstream side of the curb cut to help direct runoff into the curb cut.
- Allow a change in elevation of 4 to 6 inches between the paved surface and BSM elevation, so that vegetation or mulch build-up does not obstruct flow.



Figure 5-19: A grated curb cut allows stormwater to pass under a pedestrian egress zone to the stormwater facility.

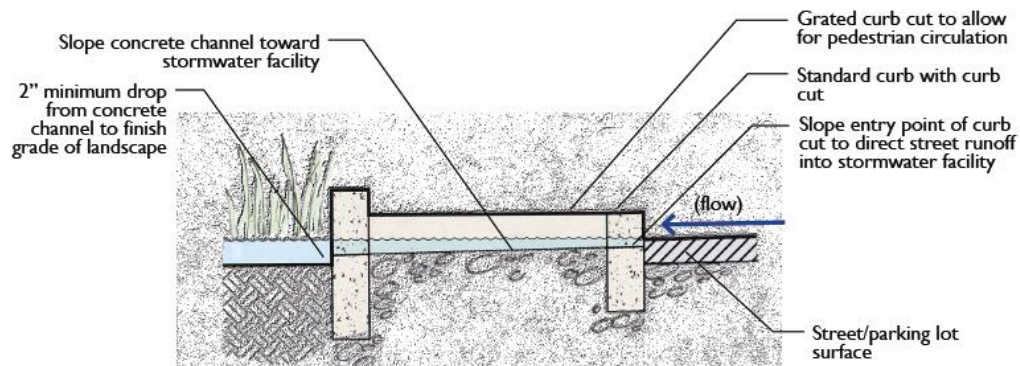


Figure 5-20: Grated curb cut: section view (Source: SMCWPPP, 2009)

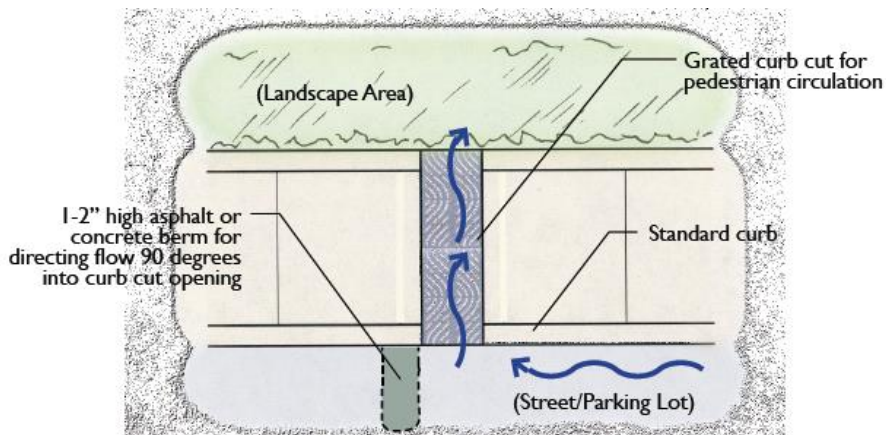


Figure 5-21: Grated curb cut: plan view (Source: SMCWPPP, 2009)

### Roof Leader (Downspout): Design Guidance

Roof leaders (commonly known as downspouts) are typically used to convey stormwater from rooftops, awnings, balconies and other elevated impervious surfaces to treatment measures on grade or a podium level (e.g., flow-through planter). This type of conveyance has the advantage of gravity and elevation allowing for flexibility of placement within the treatment measure. The outlet can be designed such that it works with the design and width of the planter. The disadvantage of the type is that water can accelerate within the conveyance causing erosion downstream when adequate measures are not taken to slow and disperse storm flow.

- Splash blocks or aprons (Figure 5-11 and 5-23) are the recommended measure for placement under roof leaders to prevent erosion where bare soil and mulch are being used. Rock or gravel is another option.
- Roof leaders should have a minimum diameter of 3 inches and a maximum diameter of 8 inches to control flow levels. This range of pipe diameters prevents blockage and erosion.
- Flow spreaders can be a useful addition to a roof leader system – especially where only one roof leader is being used to convey flow. To maximize the efficiency of a stormwater treatment measure, the flow needs to reach as much surface area as possible. Remember the mantra – slow it, spread it, sink it – as a guide for designing bioretention systems (Figure 5-22).
- Flow spreaders can be constructed using metal gutters or half-cut plastic pipes with perforations on the bottom and a cap on the downstream end. The system should sit on top of or hang above the mulch layer.



↑

Figure 5-22: This flow-through planter has a flow spreader pipe to distribute water around the surface and away from the one inlet in the images. (Credit: EOA, Inc.)

← Figure 5-23: Splash block (Credit: EOA, Inc.)

## 5.14 Underdrain

Where the existing soils have a lower permeability than soils specified for a landscape-based stormwater treatment measure, it may be necessary to install an underdrain to allow the treatment measure to function as designed and ***prevent the accumulation of standing water***. In most of San Mateo County, underdrains will be required.

Underdrains are perforated or slotted pipes that allow water to enter the pipe and flow to the storm drain system. The following guidelines are provided by SFPUC and the Countywide Program:

- To help prevent clogging, two rows of perforations or slots should be cut into the pipe. If possible, the holes or slots should only be on the underside of the pipe, at 120 degrees and 240 degrees, so that water enters the pipe primarily from the bottom and lower sides of the pipe allowing for more water storage within the system. Pipes that come pre-cut with holes or slots already in them including in the third location (as shown in Figure 5-24) at the top of the pipe can be accepted. Slots are considered less open to root intrusion than round perforations.
- Three pipe material options in order of preference are:
  1. Slotted single-walled underdrain pipes of the type HDPE SDR 17.
  2. Slotted or perforated triple-walled HDPE pipe with smooth inner and outer layers and a corrugated inner layer.
  3. Slotted or perforated PVC pipe. (HDPE is considered a “greener” building material.)
- Corrugated pipe (such as single or dual wall HDPE pipe - AASHTO M252 and M294 Types C, S and D) is not recommended. Pipes with smooth interiors are easier to clean and remove root intrusions. Corrugated pipe is also not considered as strong as solid smooth pipe.
- The SFPUC specification calls for slots to measure 0.032 inch-wide (max), be spaced at 0.25 inches (min), and provide a minimum inlet area of 5.0 square inch per linear foot of pipe. Slots shall be oriented perpendicular to the long axis of the pipe, and evenly spaced along the length of the pipe.
- The longitudinal slope of the underdrain pipe shall be a minimum of 0.5% slope.
- Cleanouts should be installed to allow access to underdrains to remove debris and root intrusion. More guidance on cleanouts is provided in Chapter 6.
- ***Underdrains should NOT be wrapped in filter fabric.***
- Underdrains should be installed within a recommended minimum 12-inch layer of Class 2 Permeable Material (Class 2 Perm) meeting the Caltrans specification below. Class 2 Perm provides an important function - replacing filter fabric - as it is permeable enough to allow water to pass through but enough fines to keep the BSM from migrating out of the system through the underdrain. A minimum depth layer of 2 inches of Class 2 Perm should be located above and below the underdrain pipe.
- Guidance for underdrains in pervious pavement systems is provided in Section 6-6.
- When designing a bioretention facility and infiltration is permitted onsite, the underdrain should be placed near the top of the Class 2 Perm layer (as shown in Figure 5-25) to allow as much water to infiltrate into native soils as possible before entering the underdrain and discharging to a storm drain. If infiltration is not permitted due to site conditions such as high groundwater, contaminated

soils, proximity to structures, etc., the bioretention facility should be lined and the underdrain placed near the bottom of the Class 2 Perm layer (as shown in Figure 5-26).

For more underdrain details, refer to the technical guidance for specific stormwater treatment measures in Chapter 6 of this guide, and in Chapters 2 through 4 of the GI Design Guide.

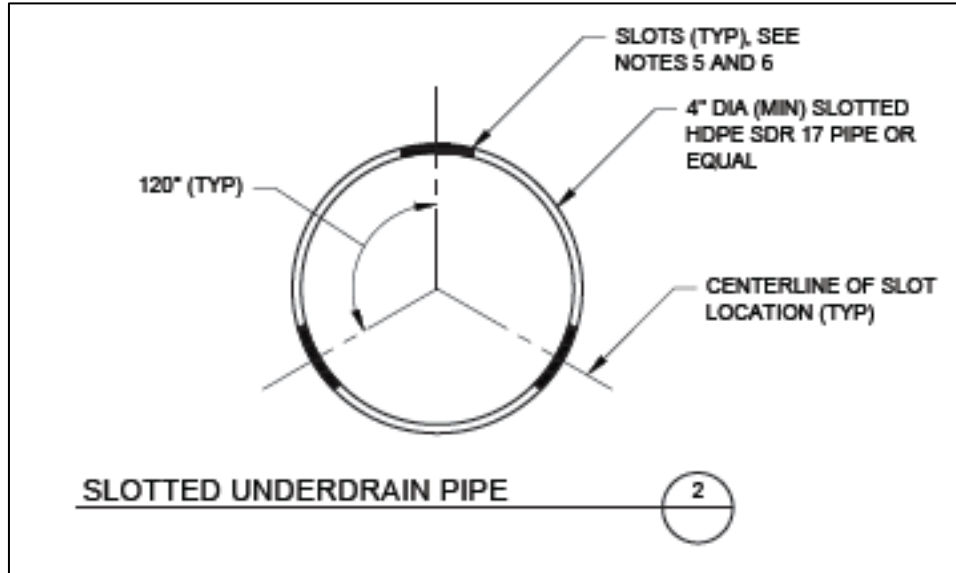


Figure 5-24: Slotted Underdrain Pipe Detail (Credit: SFPUC and GI Design Guide)

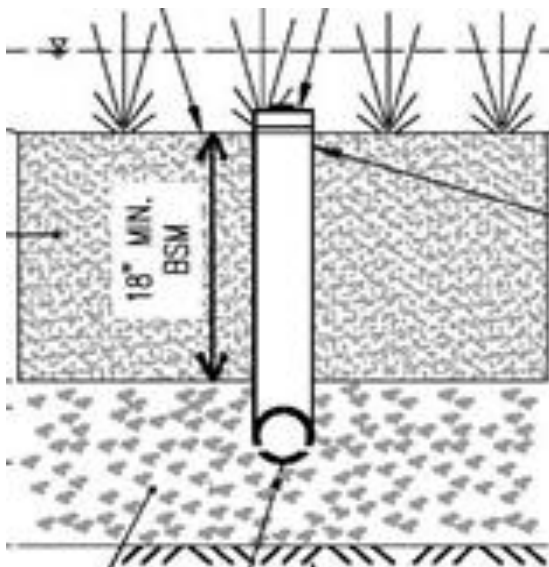


Figure 5-25: Underdrain Pipe Detail Location with maximized infiltration

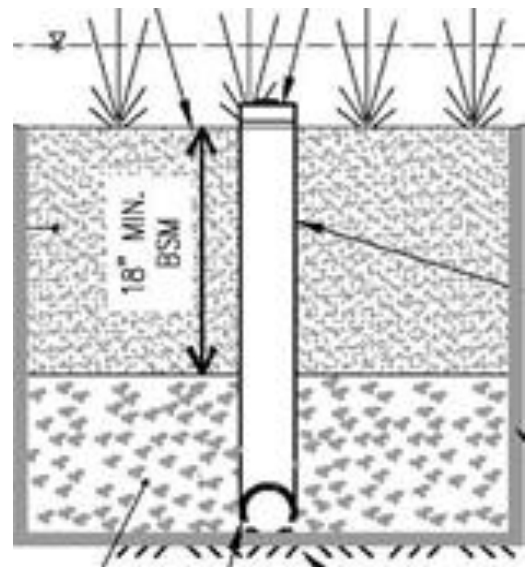


Figure 5-26: Underdrain Pipe Detail Location with no infiltration

### Caltrans Specification for Class 2 Permeable Material: Section 68-2.02F(3)<sup>29</sup>

The Caltrans Class 2 Perm specification contains the following information: “Permeable material for use in backfilling trenches under, around, and over underdrains must consist of hard, durable, clean sand, gravel, or crushed stone and must be free from organic material, clay balls, or other deleterious substances. Permeable material must have a durability index of not less than 40. Class 2 permeable material must have a sand equivalent value of not less than 75. The percentage composition by weight of Class 2 permeable material in place must comply with the gradation requirements shown in the Table 5-5.”

Class 2 permeable material is used instead of filter fabric around the underdrain; therefore, ***filter fabric should not be used with Class 2 permeable material.***

*Table 5-5: Class 2 Permeable Material Gradation Requirements*

Sieve sizes	Percentage passing
1"	100
3/4"	90–100
3/8"	40–100
No. 4	25–40
No. 8	18–33
No. 30	5–15
No. 50	0–7
No. 200	0–3

<sup>29</sup> Section 68 of the 2018 Caltrans Standards Specifications Manual:  
[http://ppmoe.dot.ca.gov/hq/esc/oe/construction\\_contract\\_standards/std\\_specs/2018\\_StdSpecs/2018\\_StdSpecs.pdf](http://ppmoe.dot.ca.gov/hq/esc/oe/construction_contract_standards/std_specs/2018_StdSpecs/2018_StdSpecs.pdf)

## 5.15 Integrating Trees and Stormwater Treatment

As discussed in Chapter 4, trees provide a variety of functions that can benefit water quality. Despite these benefits, trees that are simply planted or maintained near impervious surfaces (“interceptor trees”) cannot be credited toward treatment of those areas. However, trees can be integrated into biotreatment systems that are sized and designed to provide stormwater treatment. The types of biotreatment systems that can incorporate trees include bioretention, tree well filters, and bioretention in combination with suspended pavement systems.

In general, trees should only be **planted in bioretention systems** when the tree species is appropriate for sandy soils (or where adjacent loamy/clayey soils can be utilized and accessed by tree roots) and sufficient soil volumes and space are provided for the tree to reach mature size without causing problems with



Figure 5-27. London plane tree leaves blocking an inlet (Credit: EOA, Inc.)

surrounding infrastructure, pavement, and buildings. Overhead infrastructure, such as lighting, awnings, and utilities can also reduce space for trees or limit the list of tree species for selection to smaller stature types. The design of the system and tree species selected should also be carefully considered for future irrigation needs (especially with large tree species, as irrigation demand may increase as the tree grows, possibly causing problems in a future drought scenario.) Hybrid systems that are able to use different soil types in different sectors of the landscape can also assist in providing water retaining soils for large trees.

**Retrofitting or modifying** an existing planting area with a tree into a bioretention area with that tree can be done, but there are many design and construction issues. An arborist or landscape architect should be consulted before attempting that advanced strategy. Similarly, **if a stormwater treatment measure is proposed for a location adjacent to an existing tree of value**, then the impacts to and protection measures for the tree should

be discussed with an arborist. The design of the measure might also have to be modified to protect the tree. Trees that have not previously been inundated with water during the rainy season may have root structures that are not ready for inundation after modification into a bioretention area, which can cause health impacts. This can occur when pavement surrounds the tree and that pavement is removed as part of the retrofit.

**High volumes of leaf drop** in a short period of time can create inlet blockages in stormwater treatment measures, so leaf collection or accommodation of degradation of leaves within the stormwater landscape needs to be assessed and/or incorporated into the design before large broadleaf deciduous trees (such as the London Plane or Sycamore) are selected. Figure 5-27 shows an example of an inlet with leaf blockage. Another species of tree, the Brisbane Box, native to Australia but commonly planted in the Bay Area, is a broadleaf evergreen with large waxy leaves. Its leaves drop over longer periods of time, so this could create fewer stormwater treatment measure maintenance and inlet blockage problems. Coniferous evergreen trees generally have needles or other smaller leaf growth that is also dropped gradually. Another category of tree type is coniferous deciduous, such as the Dawn Redwood (native to China but also commonly planted in the Bay Area). Its soft leafy needles drop every autumn but are smaller in size.

Using trees to treat stormwater may be a better option than using bioretention with small plants only. Landscaping increases maintenance costs. However, over the long-term trees can be less expensive to maintain than bioretention with small plants. Installation costs can be higher with tree-based systems but can pay off in the long term.

***Soil volume, soil compaction, structural pruning, and compost***, along with appropriate irrigation during the first three years, are important to long-term tree health. Soil volume that is lightly compacted with void space for oxygen is termed “rootable soil volume” since tree roots are able to penetrate that soil. Soil that is compacted to 85% proctor or greater (as is typically done before pavement is placed over soil) is not penetrable by most tree roots. This causes infrastructure problems such as heaving sidewalks when tree roots search out other areas to grow, such as the narrow interface between concrete or asphalt and soil, where some air gaps can exist. Structural pruning during the first 10 years of a tree’s life are crucial to establish healthy growth forms that will be important when the tree is older and much larger. Other aspects that influence how street trees perform include exposure (wind and heat) and resistance to disease and pest infestations. **See Chapter 6 of the GI Design Guide for extensive information on tree maintenance.**

# Chapter 6: Technical Guidance for Specific Treatment Measures

<i>Introduction</i> .....	6-2
<i>6.1 Bioretention Area</i> .....	6-5
<i>6.2 Flow-through Planter</i> .....	6-15
<i>6.3 Tree Well Filter</i> .....	6-23
<i>6.4 Infiltration Trench</i> .....	6-33
<i>6.5 Extended Detention Basin</i> .....	6-39
<i>6.6 Pervious Pavement</i> .....	6-46
<i>6.7 Reinforced Grid Paving</i> .....	6-56
<i>6.8 Green Roof</i> .....	6-62
<i>6.9 Rainwater Harvesting and Use</i> .....	6-67
<i>6.10 Media Filter</i> .....	6-74
<i>6.11 Subsurface Infiltration System</i> .....	6-79



## Introduction

The *C.3 Regulated Projects Guide (this Guide)* and the new companion [Green Infrastructure Design Guide \(GI Design Guide\)](#) comprise the Countywide Program’s *GreenSuite*. Both documents provide technical guidance on stormwater control measures and related issues; however this Guide focuses on Regulated Projects on parcels or sites while the *GI Design Guide* includes guidance for sites as well as recommendations for projects in streets and other public areas. Figure 6-1 below displays how the two Guides overlap and describes what is covered in **Chapters 2 through 4 of the *GI Design Guide*** related to site-based projects.

*This chapter of the Guide is intended to help designers select and design appropriate treatment measures for parcel-based projects.* This chapter covers the most common treatment measures used in San Mateo County (see Table 6-1) and was developed using best engineering judgment based on a review of various documents (see references at the end of this Guide), experience with review of designs and inspection of installations of treatment measures, and guidance from Water Board staff as available. The cross-section and plan view details provided are not intended for use in construction plans without customization for the conditions on the specific projects. This chapter primarily provides **design** guidance with some recommendations related to how design and maintenance considerations need to be integrated and maintenance issues that should be considered and planned for during the design stage.

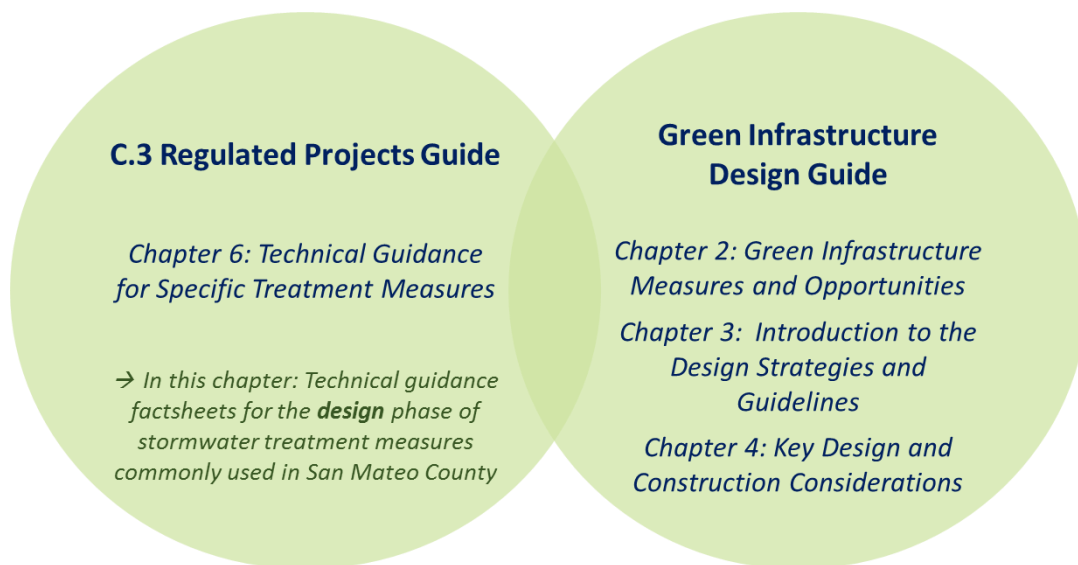


Figure 6-1: Chapter 6 details and cross-references to the Green Infrastructure Design Guide

## Categories of Treatment Measures

Design guidance for each measure is provided in the corresponding section shown in Table 6-1. Most of the treatment measures presented in this chapter are considered LID measures in the context of the Municipal Regional Permit. Terminology used below is consistent with the GI Design Guide to the extent feasible – some differences arise out of the variable conditions in which treatment measures, non-LID measures, and alternative treatment measures are designed and built.

*Table 6-1: Treatment Measures for which Technical Guidance is Provided*

Category	Treatment Measures	Section
LID	Bioretention Area	6.1
LID	Flow-through Planter	6.2
LID and Non-LID	Tree Well Filter	6.3
LID	Infiltration Trench	6.4
Non-LID	Extended Detention Basin	6.5
LID	Pervious Pavement	6.6
LID	Reinforced Grid Paving	6.7
LID	Green Roof	6.8
LID	Rainwater Harvesting and Use	6.9
Non-LID	Media Filter	6.10
LID	Subsurface Infiltration System	6.11

## Location

Control measures should be in areas that can be accessible at any given time for the purpose of operation and maintenance and inspections (see Table 6-2 for example locations). **Control measures should not be located in inaccessible private property**, such as residential backyards (exceptions exist for pervious pavement). Ensure requirements needed for access are in place (e.g., easements, access routes for vehicles, material delivery or equipment for maintenance, and permission to access areas in maintenance agreements).

Table 6-2: Recommended Locations for Treatment Measures

Location	Bioretention Area	Flow-through Planter	Tree Well Filter	Infiltration Trench	Extended Detention Basin	Pervious Pavement	Reinforced Grid Paving	Green Roof	Rainwater Harvesting and Use	Media Filter	Subsurface Infiltration System
Parking Lot	•	•	•	•		•	•		•	•	•
Roof		•						•	•		
Driveway	•	•	•	•		•	•			•	•
Podium-level		•						•	•		
Close to Buildings		•	•			•			•	•	
Away from Buildings	•	•	•	•	•	•	•		•	•	•
Underground			•						•	•	•

## 6.1 Bioretention Area

### Overview



Figure 6-2: Bioretention area (Credit: City of Brisbane)

### Description

Bioretention areas (also known as “rain gardens”) are concave or low and flat landscaped areas that function as soil and plant-based filtration devices that remove pollutants through physical and biological treatment processes. Bioretention areas can be any shape, including linear. Linear bioretention areas are sometimes referred to as stormwater planters. The GI Design Guide alternatively refers to bioretention areas as stormwater planters, stormwater curb extensions or rain gardens depending on the setting/location. Rain gardens in residential settings are sometimes simple bowl-shaped landscapes.

Bioretention areas consist of the following layers, starting from the top: a surface ponding area, plants, a layer of mulch, Biotreatment Soil Media (BSM), and an underlying layer of Class 2 Permeable material (Class 2 Perm) with an underdrain (if needed) that connects to the municipal storm drain system.

Bioretention areas should be designed to distribute stormwater runoff evenly within the surface ponding area. The water is temporarily stored in the ponding area and infiltrates through the BSM, which is engineered to have a high rate of permeability. From there, the water filters down into the underlying Class 2 Perm layer.

The Class 2 Perm layer of the bioretention area may be designed to either maximize infiltration or prevent infiltration to the underlying soils. In bioretention areas that maximize infiltration, the underdrain should be raised at least 6 inches above the bottom of the Class 2 Perm layer, and there should be no liner between the bottom of the Class 2 Perm layer and the surrounding soils. Maximizing infiltration is encouraged where conditions are suitable for infiltration – check with the geotechnical engineer. Where infiltration is precluded, the bioretention area should be fully lined with waterproof material, and the underdrain placed at the bottom of the Class 2 Perm layer.

#### Best uses

- Any type of development
- Drainage area up to two acres
- Landscape design element

#### Advantages

- Detains low flows
- Landscape feature
- Low maintenance
- Reliable once established

#### Limitations

- Not appropriate where soil is unstable
- Typically requires irrigation
- Susceptible to clogging if installed without protection from construction site soils

## 6.1 Bioretention Area

For strategies and examples of how to retrofit sites and parcels to include bioretention areas, see Sections 3.2 and 3.3 of the GI Design Guide.

Remember that stormwater control measures should be located in areas that can be accessible at any given time for the purpose of operation and maintenance and inspections. Bioretention units should not be located on inaccessible private property such as residential backyards. See Table 6-3 below for recommended bioretention area locations.

### Siting

*Table 6-3: Recommended locations for bioretention areas (rain gardens)*

Recommended Locations	Bioretention
Parking Lot	●
Roof	
Driveway	●
Podium-level	
Close to building	
Away from Buildings	●
Underground	



*Figure 6-3: Bioretention area in a multi-family residential property in Redwood City (top; Credit: EOA, Inc.) and in a parking lot in Burlingame (bottom; Credit: SMCWPPP)*

## Design and Sizing Guidelines

### Drainage Area and Setback Requirements

- Setback from structures 10' or as required by structural or geotechnical engineer, or local jurisdiction.
- Follow property line set-back requirements per local jurisdiction zoning. If the bioretention area is on or near the property line, consider if flow from adjacent properties that may cross the property line will affect the sizing of the system.
- Area draining to the bioretention area should not exceed 2 acres.
- Area draining to the bioretention area should not contain a significant source of soil erosion, such as high velocity flows along slopes not stabilized with vegetation or hardscape.
- Areas immediately adjacent to bioretention area should have slopes more than 0.5% for pavement and more than 1% for vegetated areas.

### Treatment Dimensions, Grading and Sizing

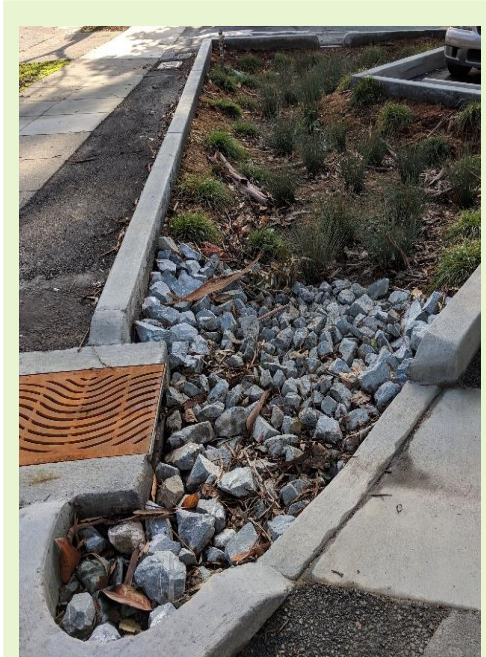
- It is recommended that bioretention areas be sized to 4% of the impervious surface area on the project site which corresponds to a surface loading rate of 5 inches per hour and a rainfall intensity of 0.2 inches per hour. The area of impervious surface multiplied by 0.04 sizing factor will equal the footprint of the bioretention area. Alternatively, if there are site or infiltration constraints, bioretention sizing may be calculated using the flow-based treatment standard, or the combination flow- and volume-based treatment standard described in Section 5.1 based on the flow entering the basin at the treatment flow rate over the initial hours of the storm until the treatment volume is attained. See Appendix E for more guidance on infiltration issues.
- Where there is a positive surface overflow, bioretention areas should have freeboard of at least 0.2 feet to the lowest structural member versus the 100-year storm water level in the bioretention area, unless local jurisdiction has other requirements.
- Where the bioretention area is in a sump that depends on outflow through a catch basin, the bioretention area should have a freeboard of at least 0.5 feet to the lowest building finished floor elevation (including garage and excluding crawl space) for conditions with the outlet 50 percent clogged, unless local jurisdiction has other requirements. Where the freeboard cannot be provided, an emergency pump may be allowed on a case-by-case basis.
- Allow 2 inches of freeboard between the rim elevation of the outfall grate and elevation of the emergency overflow above the overflow grate such as the top of a flow-through planter wall.
- Side slopes should not exceed 3:1; downstream slope for overflow should not exceed 3:1.
- Bioretention areas, including linear treatment measures, should not be constructed on slopes greater than 4%, unless constructed as a series of relatively horizontal bioretention cells. A bioretention facility should be one level (maximum 2% inner cell slope), shallow basin or a series of basins. As runoff enters each basin, it should flood and fill throughout before runoff overflows to the outlet or to the next downstream basin. This will help prevent movement of surface mulch and soil. In a linear bioretention area, check dams should be placed for every 4 to 6 inches of elevation change and so that the top of each dam is at least as high as the toe of the next upstream

dam. A similar principle applies to bioretention facilities built as terraced roadway shoulders<sup>31</sup>. The slope within cells should not exceed 2% and check dams should be used to hold flow above the 2% level before allowing flow to enter the next cell. Bioretention cells are not recommended if overall slope exceeds 8%. If designing a sloped bioretention area with a surface reservoir (volume method or combined flow and volume method), the slope will have to be factored in the calculation of the surface reservoir height. See Appendix E for more guidance on infiltration measures. **See Section 4.3 of the GI Design Guide for guidance on how to deal with steep topography** using check dams and weirs.

- Surface ponding depths may vary, with a recommended depth of 6 inches (measured from the top of the BSM layer – not the mulch layer - to the overflow rim elevation) and a maximum depth of 12 inches. If ponding depths exceed 6 inches, the landscape architect may want to consider effects on the planting palette. The 3" mulch layer can be within the 6" ponding depth.

### Inlets to Treatment Measure

- Flow may enter the treatment measure in the following ways (see example drawings in Section 5.13):
  - As overland flow from landscaping (no special requirements);
  - As overland flow from pavement (cutoff wall required);
  - Through a curb opening;
  - Through a curb drain;
  - Within a drop structure through a stepped manhole (refer to Figure 5-1 in Section 5.6);
  - Through a bubble-up emitter; and/or
  - Through a roof leader or other conveyance from a building roof.
- Where flows enter the biotreatment area, allow a change in elevation of 4-6 inches between the paved surface and the biotreatment soil media elevation (i.e., a recommended 2" drop from the inlet to the mulch or splash block), so that vegetation or mulch build-up does not obstruct flow.
- Splash blocks or splash aprons with or without grouted cobble, pea gravel, plants or mulch should be installed to dissipate flow energy and velocity where runoff enters the treatment measure, and at the downstream side of tiers, weirs and check dams to prevent erosion.



*Figure 6-4: Examples of curb cut inlets at a bioretention area in Burlingame (Credit: City of Burlingame)*

<sup>31</sup> Contra Costa Clean Water Program. February 2012. C.3 Stormwater Guidebook, 6th Edition and Stormwater Management Handbook: Implementing Green Infrastructure in Northern Kentucky Communities, 2009. [www.epa.gov/smartgrowth/publications.htm](http://www.epa.gov/smartgrowth/publications.htm)

- Curb openings should be a minimum of 18 inches wide (or 12" if allowed by the municipality), with the number and locations designed so that runoff is dispersed throughout the bioretention area or through the use of a flow spreading system.
- Bubble-up emitters and pipes to bubble-up emitters should have weep holes to avoid standing water inside after storm events.

### Vegetation



*Figure 6-5: Bioretention area featuring several plant types (Credit: City of Burlingame)*

- Plant species should be suitable to well-drained soil and occasional inundation. See planting guidance in Appendix A.
- Shrubs and small trees should be placed to anchor the bioretention area cover.
- Tree planting should be as required by the municipality. If larger trees are selected, plant them at the periphery of the bioretention area, where roots can access non-BSM soils outside the area. See guidance on integrating trees and bioretention areas in Appendix A.
- Underdrain trenches can be placed at the edge of tree planting zones, as needed, to maximize distance between tree roots and the underdrain, but the underdrain trench must still be located somewhere under the BSM section and within the Class 2 Perm material layer.
- Use integrated pest management (IPM) and/or Rescape (Bay-Friendly) principles in the landscape design to help avoid or minimize any use of synthetic pesticides and quick-release fertilizer. Check with the local jurisdiction for any local policies regarding the use of pesticides and fertilizers. See additional guidance in Appendix A.
- Irrigation should be provided as needed to maintain plant health. If irrigation cannot be provided, then watering by hand should be accommodated weekly through plant establishment – typically through the first six months depending on the season and levels of precipitation.
- Trees and vegetation should not block inflow, create traffic or safety issues, or obstruct utilities.



### Soil and Drainage Considerations Specific to Bioretention Areas

- Consideration of groundwater level and placement of the underdrain:
  1. If there is less than a 5-foot separation between the bottom of the facility and the seasonal high groundwater level, or infiltration is not allowed due to other site constraints, an impermeable liner should be placed between the Class 2 Perm and the bottom of the facility and the underdrain placed on top of that liner.
  2. If there is at least a 5-foot separation between the bottom of the facility and the seasonal high groundwater level, and geotechnical conditions allow infiltration, the facility should be unlined and the underdrain should be raised at least 6 inches above the bottom of the Class 2 Perm to allow storage and infiltration of treated water.

### Soil and Drainage Considerations for All Biotreatment Systems

- Soil used in the bioretention area must meet the biotreatment soil media (BSM) specification included in Appendix K. Check with municipality for any additional requirements.
- Bioretention areas should have a minimum BSM depth of 18 inches.
- Install and maintain a 3-inch layer of composted wood mulch, consistent with the new regional [Biotreatment Wood Mulch \(BWM\)](#) specification<sup>32</sup> in areas between plantings. Installing and maintaining a 3-inch layer of BWM is consistent with the State Water Efficient Landscape Ordinance (see Section 5.7 of this Guide for more details). Alternatively, biotreatment area sod<sup>33</sup>, that provides 100% soil coverage or rock mulch may be used. However, rock mulch, such as cobble or gravel, should be used sparingly and only where absolutely necessary. “Micro-bark”, or “gorilla hair” mulches, as well as chipped wood mulch from recycled pallets and dimensional lumber, are not recommended. **See Sections 4.9 and 6.3 of the GI Design Guide** for more information on mulch.
- An underdrain system is generally required. Depending on the permeability of in situ soils, the local jurisdiction may allow installation without an underdrain on a case-by-case basis.
- Filter fabric should not be used around the underdrain or between the BSM and Class 2 Perm layer. Class 2 Perm performs the function of filter fabric (keeping the BSM from exiting the system through the underdrain) but is less prone to clogging.
- The underdrain should consist of a solid perforated or slotted HDPE or PVC pipe connected to a cleanout pipe(s) and to a storm drain or discharge point. Solid HDPE or triple-walled HDPE pipe, with smooth inner and outer layers and a corrugated middle layer, are recommended. The cleanout should consist of a vertical, rigid, non-perforated, non-corrugated PVC or HDPE pipe, with a minimum diameter of 4 inches and a watertight cap fit, raised or flush with the ground, or as required by municipality. There should be adequate fall (min. 0.5% slope) from the underdrain to the storm drain or discharge point. See Section 5.14 for more information on underdrains.
- The underdrain should be placed in a 12-inch thick layer of Caltrans Class 2 permeable material, or similar municipality-approved material. See Section 5.14 for more information on Class 2 permeable material.

---

<sup>32</sup> See the [Biotreatment Wood Mulch specification](#) on the Flowstobay website: [www.flowstobay.org/newdevelopment](http://www.flowstobay.org/newdevelopment)

<sup>33</sup> Such as [Biofiltration Sod](#) from the Delta Blue Grass company.

### *Construction Requirements and Maintenance Plans*

#### Construction Requirements for All Biotreatment Systems

- When excavating, avoid spreading fines of the soils on bottom and side slopes. Remove any smeared soiled surfaces and provide a natural soil interface into which water may percolate.
- Minimize compaction of existing soils. Protect from construction traffic.
- Protect the area from construction site runoff. Runoff from unstabilized areas should be diverted away from biotreatment facility.
- ***For additional construction guidelines, see Chapters 2, 4 and 5 of the GI Design Guide.*** Specifically, see Sections 4.3 through 4.9 for construction strategies for dealing with slopes, overflows, poor soils, utilities, runoff capture, etc.

#### Remember

#### Maintenance Considerations for All Treatment Measures

- See Chapter 8 of this Guide for specific maintenance guidance. Specifically, see Section 8.3.1 for common maintenance concerns encountered for bioretention areas.
- ***See Chapter 6 of the GI Design Guide*** for landscape maintenance recommendations and information.
- A Maintenance Agreement should be provided and should state the parties' responsibility for maintenance and upkeep.
- Prepare a maintenance plan and submit with Maintenance Agreement. Maintenance plan templates are in Appendix G

### Typical Design Details

Note that even though not shown in the details below, 3" of mulch will need to be added on top of the biotreatment soil media for all bioretention area measures - 2" of freeboard is also recommended.

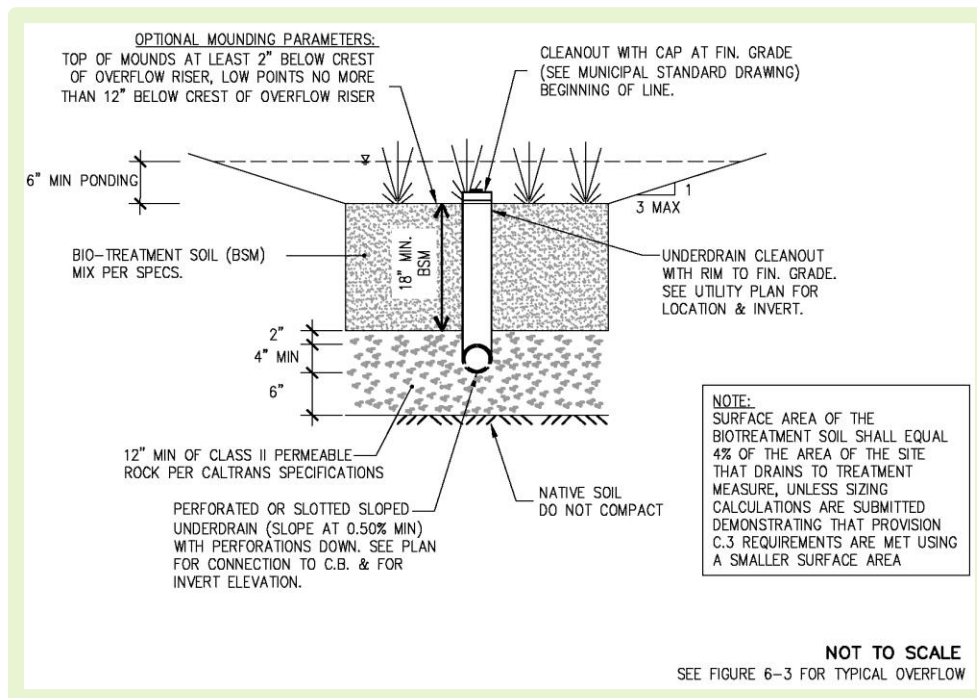


Figure 6-6: Cross Section, Bioretention Area with Infiltration

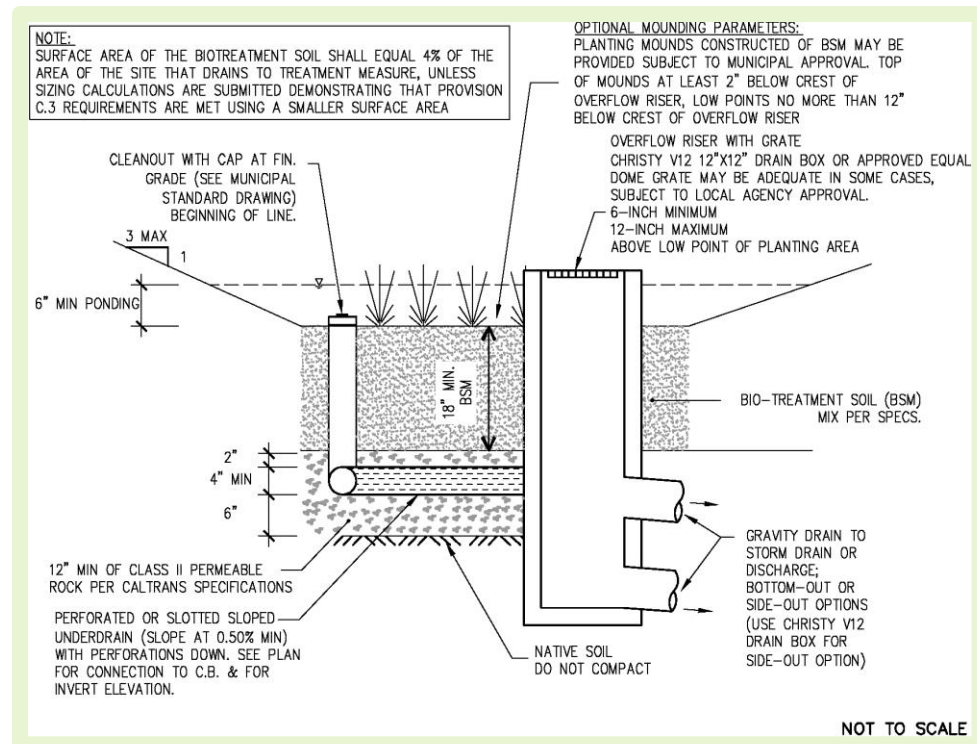


Figure 6-7: Cross Section, Bioretention Area (side view) with Infiltration

## 6.1 Bioretention Area

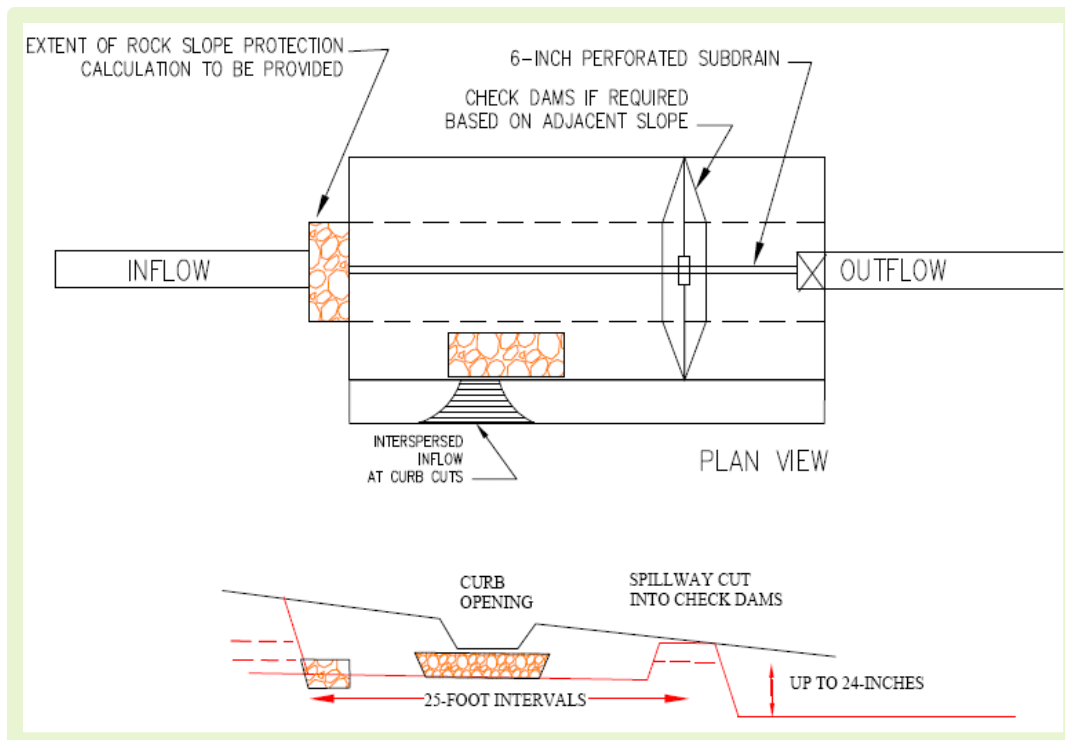


Figure 6-8: Check dam (plan view and profile) for installing a series of linear bioretention cells in sloped area

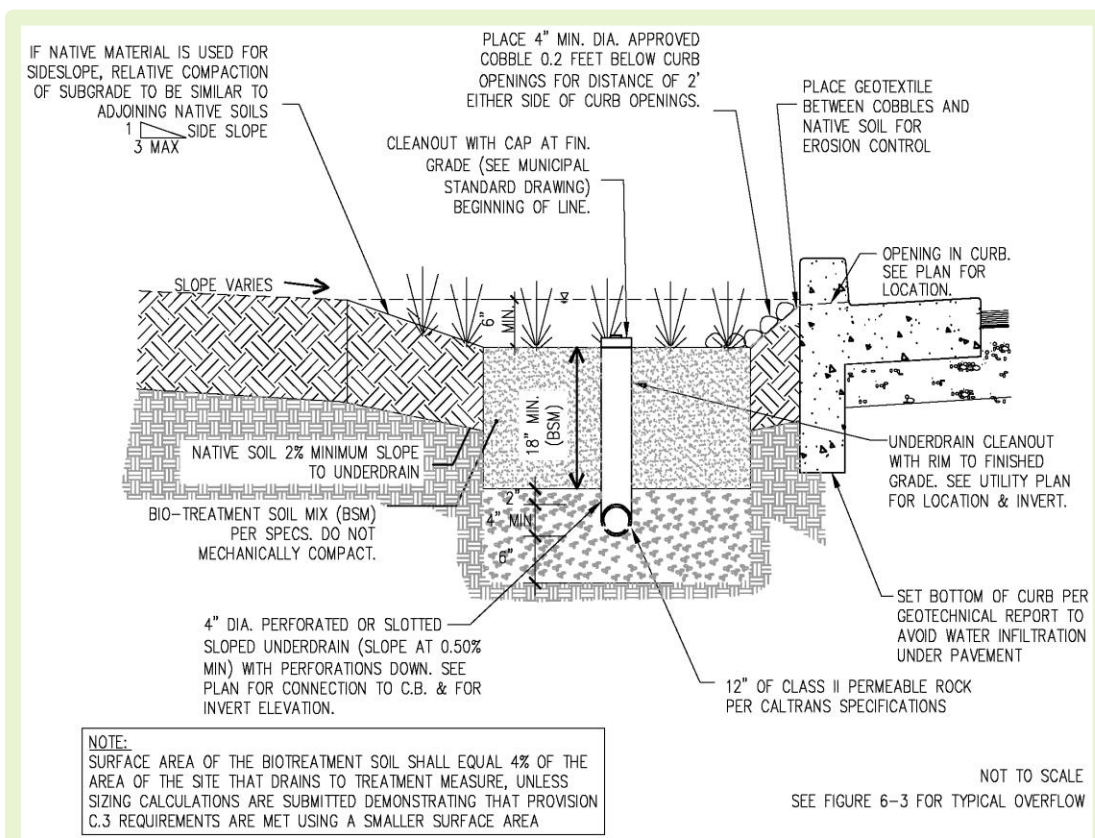


Figure 6-9: Cross-section of bioretention area with infiltration showing inlet from pavement.

## 6.1 Bioretention Area

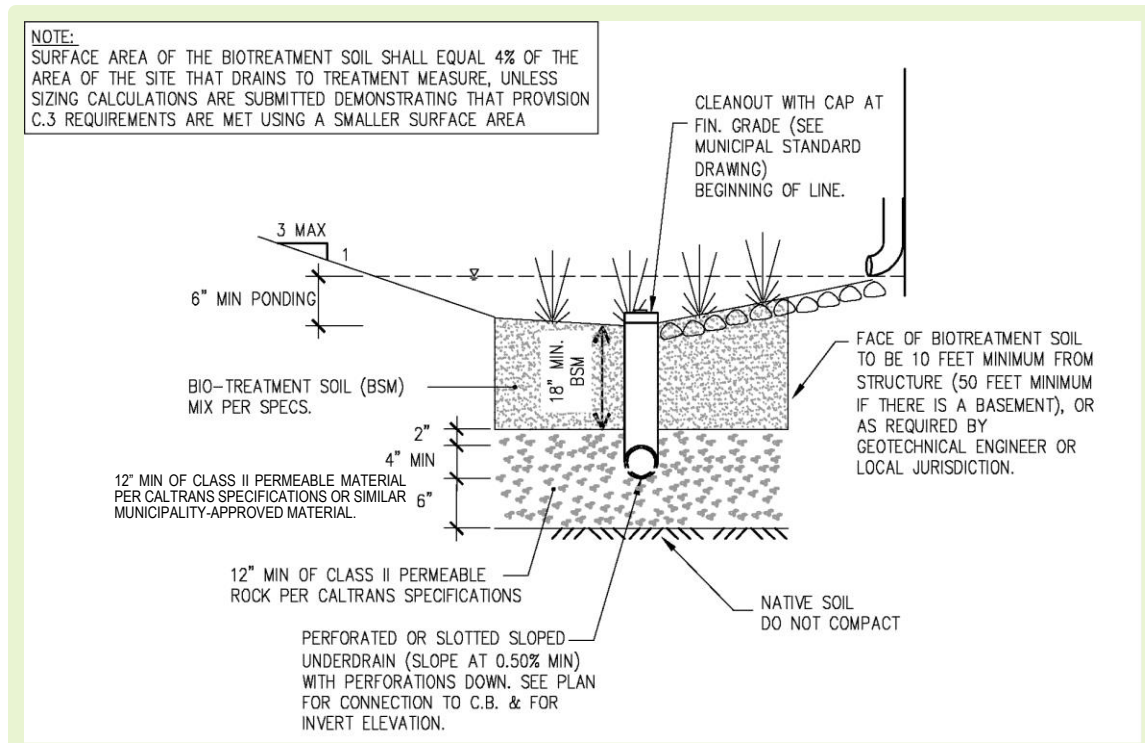


Figure 6-10: Bioretention area in landscaping to treat runoff from rainwater leaders (Not to Scale)

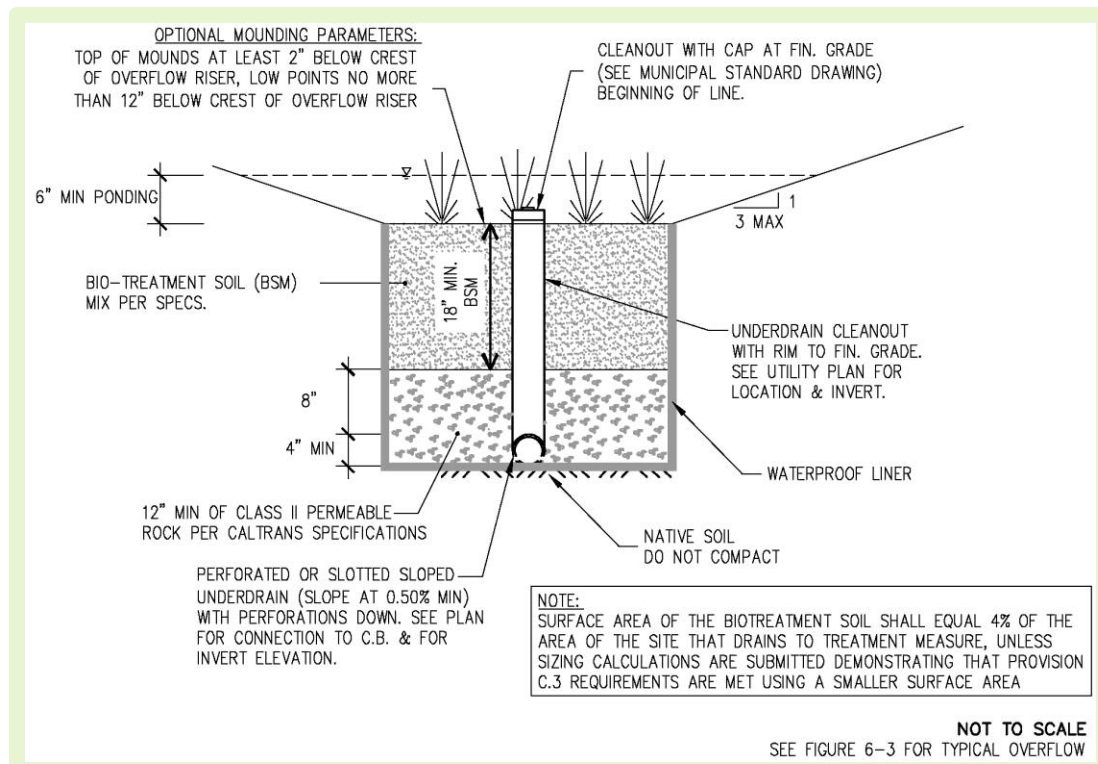


Figure 6-11: Cross section of lined bioretention area, for locations where infiltration is precluded.

## 6.2 Flow-through Planter

### Overview

#### Description

Flow-through planters are a type of contained biotreatment system designed to treat and detain runoff without allowing infiltration into the underlying soil. They can be used next to buildings and other locations where soil moisture, water infiltration or intrusion is a potential concern. Flow-through planters are typically constructed above grade in concrete boxes receiving runoff via downspouts from roofs of adjacent buildings. However, they can also be built level with surrounding surfaces receiving sheet flow (“below-grade flow-through planter”). Pollutants are removed as the runoff passes through the BSM and is collected in an underlying layer of Class 2 permeable material. A perforated underdrain must be directed to a storm drain or other discharge point. An overflow inlet conveys flows that exceed the capacity of the planter.



Figure 6-12: Flow-through planter (Credit: EOA, Inc.)

#### Best uses

- Treating roof runoff
- Next to buildings
- Dense urban areas
- Locations where infiltration is not desired and/or feasible

#### Advantages

- Can be adjacent to structures
- Multi-use
- Versatile
- May be any shape
- Low maintenance

#### Limitations

- May require sufficient head
- Careful selection of plants
- Does not allow for infiltration of water into native soil
- Needs redundant systems in case of clogging.

## 6.2 Flow-through Planter

For strategies and examples of how to retrofit sites and parcels to include flow-through planters, see **Sections 3.2 and 3.3 of the GI Design Guide**.

Remember that stormwater control measures should be located in areas that can be accessible at any given time for the purpose of operation and maintenance and inspections. Flow-through planters should not be located on inaccessible private property such as residential backyards. Ideally, planters should be located in areas that are visible from the nearby walkway/patio. Make sure the planter wall is low enough to allow for visual inspection from the adjacent walking surface. A maximum height of 5 feet from the walking surface to the top of the planter wall is recommended.

### Siting

*Table 6-4: Recommended locations for flow-through planters*

Recommended Locations	Flow-through Planter
Parking Lot	●
Roof	●
Driveway	●
Podium-level	●
Close to building	●
Away from Buildings	●
Underground	



*Figure 6-13: Flow-through planter with gravel rock mulch. (Credit: City of Burlingame)*

## Design and Sizing Guidelines

### Treatment Dimensions and Sizing

- It is recommended that flow-through planters be designed with a 4% sizing factor (percentage of the surface area of planter compared to the surface area of the tributary impervious area). The area of impervious surface multiplied by 0.04 sizing factor will equal the footprint of the flow-through planter. Alternatively, if there are site constraints, calculations may be performed using either the hydraulic sizing criteria for flow-based treatment measures or the hydraulic sizing criteria for combination flow- and volume-based treatment measures, included in Section 5.1.
- Install an overflow system adequate to meet municipal drainage requirements.
- Flow-through planters can be used adjacent to building and within set back areas, if allowed.
- Flow-through planters can be used above or below grade and on podiums or roof tops with sufficient structural capacity and waterproofing.
- Size the overflow grate per the MRP C.3.d sizing or per any locally-required design storm, set rim elevation of grate at least 2" below top of planter box walls and top of water proofing on building side. A minimum sized grate opening of 4" is recommended to allow for cleanout.
- Planter wall set against the building should be at least 2" higher than the opposite side of the planter to avoid overflow against building.
- Elevation of the surface area should be generally level, but may vary as needed to distribute stormwater flows throughout the surface area. For example the BSM can be graded slightly (1%) away from inlet(s) to the rest of the planter area. If the available planter surface area exceeds the C.3.d-required sizing (4%), then the excess square footage can be mounded, can have different soil types, and/or can have different plant types in those areas providing more variety.
- Provide a minimum of 2 inches, and a maximum of 12 inches of water surface storage between the BSM and rim of overflow. 6 inches is the recommended design ponding depth.
- Flow-through planters should be located in areas that can be accessible at any given time for the purpose of operation and maintenance and inspections. A maximum planter wall height (measured from the walking surface to top of wall) of 5 feet is recommended for inspections.

### Inlets to Treatment Measure

- Flow may enter the treatment measure (see example drawings in Section 5.13):
  - As overland flow from landscaping (no special requirements);
  - As overland flow from pavement (cutoff wall required);
  - Through a curb opening;
  - Through a curb drain;
  - Within a drop structure through a stepped manhole (refer to Figure 5-3 in Chapter 5);
  - Through a bubble-up inlet or storm drain emitter with sufficient head;
  - Through a roof leader, downspout or other conveyance from building roof; and/or
  - Through a runnel, swale, valley gutter or other conveyance system.



## 6.2 Flow-through Planter

- If the flow-through planter is installed at grade, allow a change in elevation of 4 to 6 inches between the surrounding paved surface and the biotreatment soil media elevation, so that vegetation or mulch build-up does not obstruct flow.
- If the flow-through planter is installed above grade, sufficient head must be provided for bubble-up emitters to discharge to the planter surface.
- Bubble-up emitters and pipes to bubble-up emitters should have weep holes to avoid standing water inside after storm events.
- Splash blocks, inlet boxes, strategically located plants or rock mulch should be installed to dissipate flow energy where runoff enters the treatment measure.
- Curb openings should be a minimum of 18 inches wide (or 12" if allowed by the municipality) with the number of openings and locations designed so that runoff is dispersed throughout the bioretention area or with the use of a flow spreader system.
- For long linear planters, space inlets to planter at 10-foot intervals or install a flow spreader.



Figure 6-14: Close-up of flow-through planter with flow spreader. (Credit: EOA, Inc.)

### Vegetation

- Plantings should be selected for viability in a well-drained soil. See plant guidance in Appendix A.
- Use ReScape (Bay-Friendly) principles and practices such as choosing the right plant for the right place and integrated pest management (IPM) in the landscape design to help avoid or minimize any use of synthetic pesticides and quick-release fertilizer. Check with the local jurisdiction for any local policies regarding the use of pesticides and fertilizers.
- Irrigation should be provided, as needed, to maintain plant life. If irrigation cannot be provided, then watering by hand should be accommodated weekly through plant establishment – typically through the first six months depending on the season and levels of precipitation.

- Choose vegetation that will not block inflows, outlets, create traffic or safety issues, or obstruct utilities at the time of installation or when plants grow to their mature size.

### Soil and Drainage Considerations Specific to Flow-through Planters

- Waterproofing should be installed as required to protect adjacent building foundations.
- An underdrain system is required for flow through planters.
- To avoid excess hydraulic pressure on subsurface treatment system structures:
  - The depth to seasonal high groundwater level should be at least 5 feet from the bottom of the structure.
  - A geotechnical engineer should be consulted for situations where the bottom of the structure is less than 5 feet from the seasonal high groundwater level.

### Soil and Drainage Considerations for All Biotreatment Systems

- The biotreatment soil media should have long term minimum permeability of 5 inches per hour (although the initial permeability may exceed this to allow for a tendency of the permeability to reduce over time.) Soil specifications are provided in Appendix K. Check with municipality for additional requirements.
- The biotreatment soil media layer should be a minimum of 18 inches deep.
- Soil used in the planter must meet the BASMAA biotreatment soil media (BSM) specification included in Appendix K. Check with municipality for any additional requirements.
- Install and maintain a 3-inch layer of composted wood mulch, consistent with the new regional Biotreatment Wood Mulch (BWM) specification<sup>34</sup> in areas between plantings. Installing and maintaining a 3-inch layer of BWM is consistent with the State Water Efficient Landscape Ordinance (see Section 5.7 of this Guide for more details). Alternatively, biotreatment area sod<sup>35</sup>, that provides 100% soil coverage or rock mulch may be used. However, rock mulch, such as cobble or gravel, should be used sparingly and only where absolutely necessary. “Micro-bark”, or “gorilla hair” mulches, as well as chipped wood mulch from recycled pallets and dimensional lumber, are not recommended. **See Sections 4.9 and 6.3 of the GI Design Guide** for more information on mulch.
- Filter fabric should not be used around the underdrain or between the BSM and Class 2 Perm layer. Class 2 Perm performs the function of filter fabric (keeping the BSM from exiting the system through the underdrain) but is less prone to clogging.
- The underdrain should consist of a solid perforated or slotted HDPE or PVC pipe connected to a cleanout pipe(s) and to a storm drain or discharge point. Solid HDPE or triple-walled HDPE pipe, with smooth inner and outer layers and a corrugated middle layer, are recommended. The cleanout should consist of a vertical, rigid, non-perforated, non-corrugated PVC or HDPE pipe, with a minimum diameter of 4 inches and a watertight cap fit, raised or flush with the ground, or as

---

<sup>34</sup> See the [Biotreatment Wood Mulch specification](#) on the Flowstobay website: [www.flowstobay.org/newdevelopment](http://www.flowstobay.org/newdevelopment)

<sup>35</sup> Such as [Biofiltration Sod](#) from the Delta Blue Grass company.

required by municipality. There should be adequate fall (min. 0.5% slope) from the underdrain to the storm drain or discharge point. See Section 5.14 for more information on underdrains.

- The underdrain should be placed at the bottom of a 12-inch thick layer of Caltrans Class 2 permeable material, or similar municipality-approved material. See Section 5.14 for more information on Class 2 Perm material.

### *Construction Requirements and Maintenance Plans*

#### Construction Requirements for All Biotreatment Systems

- Minimize compaction of BSM. Protect from construction traffic.
- Protect the area from construction site runoff. Runoff from unstabilized areas should be diverted away from the Flow-through Planter.
- For *additional construction guidelines, see Chapter 4 of the GI Design Guide*. Specifically, see **Sections 4.3 through 4.9 of the GI Design Guide** for construction strategies for dealing with slopes, overflows, poor soils, utilities, runoff capture, etc.

#### Remember

#### Maintenance Considerations for All Treatment Measures

- See Chapter 8 for specific maintenance guidance. Specifically, see Section 8.3.2 for common maintenance problems specific to flow-through planters.
- **See Chapter 6 of the GI Design Guide** for landscape maintenance recommendations and practices.
- A Maintenance Agreement should be provided and should state the parties' responsibility for maintenance and upkeep.
- Prepare a maintenance plan and submit with Maintenance Agreement. Maintenance plan templates are in Appendix G.

Typical Design Details

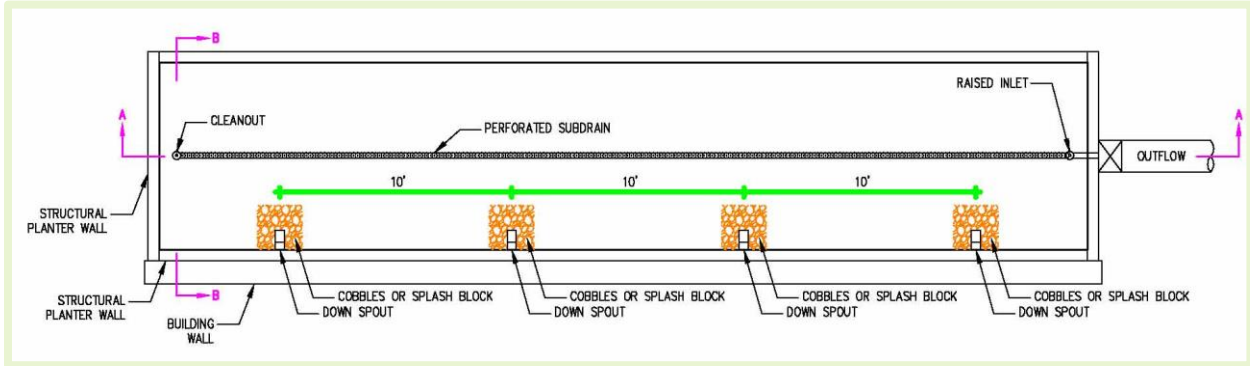


Figure 6-15: Plan view of long, linear planter, with inlets to the planter distributed along its length at 10' intervals.

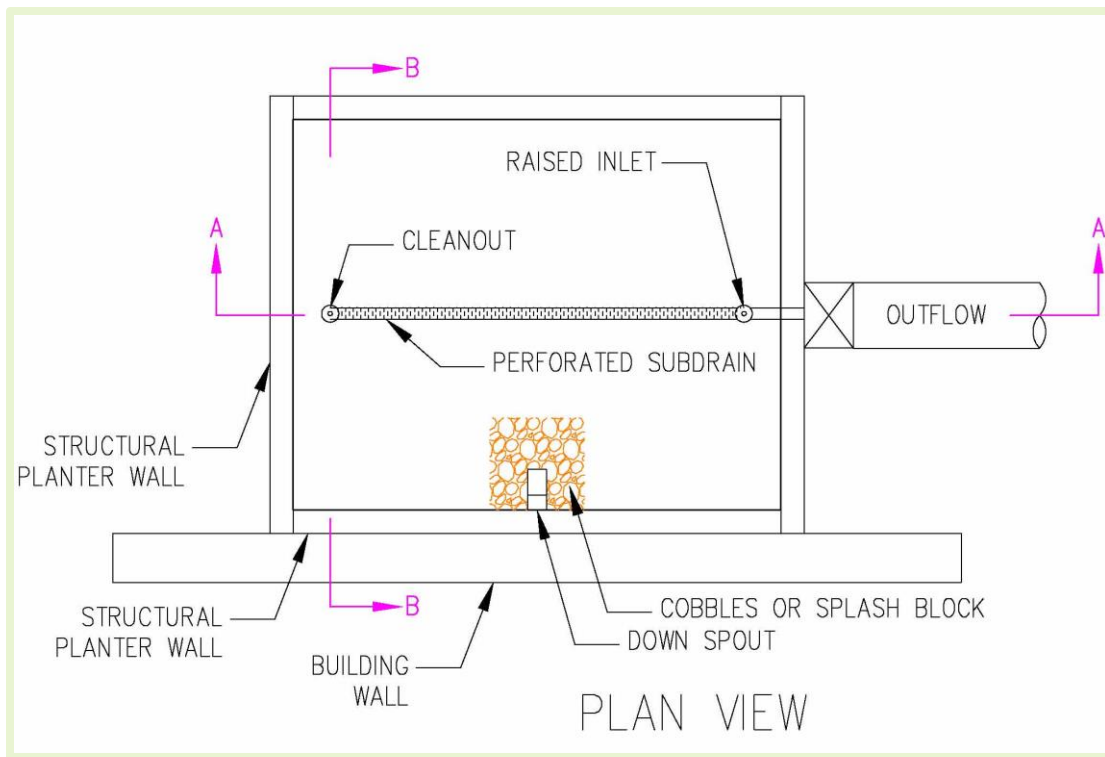


Figure 6-16: Plan view of planter designed to disperse flows adequately with only one inlet to planter

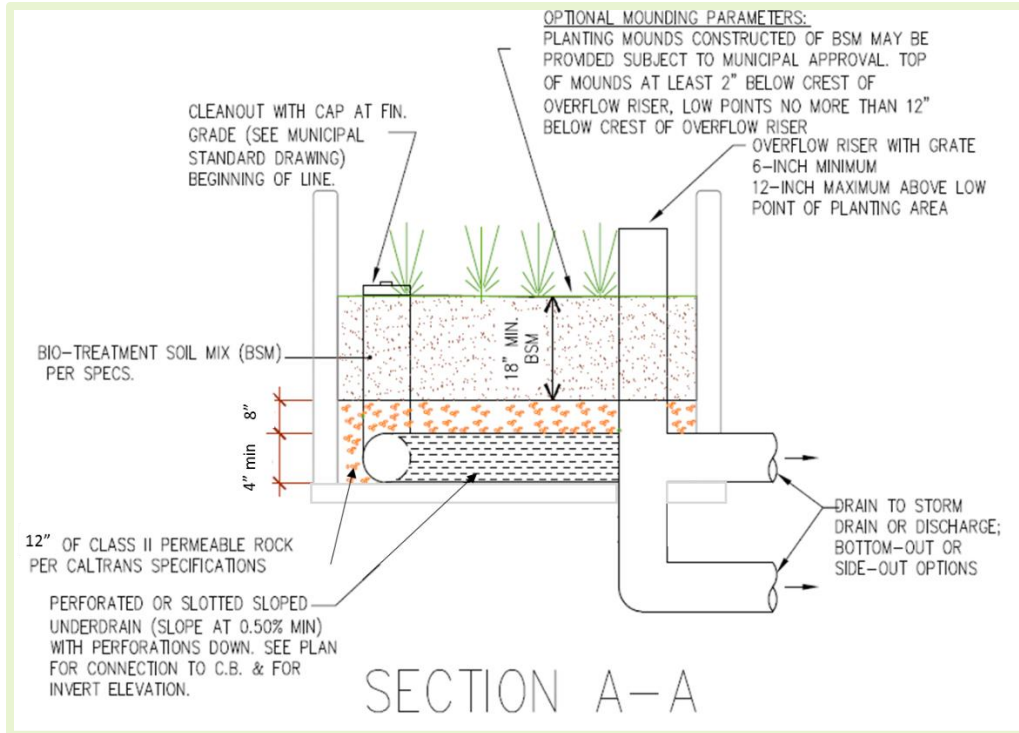


Figure 6-17: Cross section A-A of flow-through planter, shows side view of underdrain (Not to Scale)

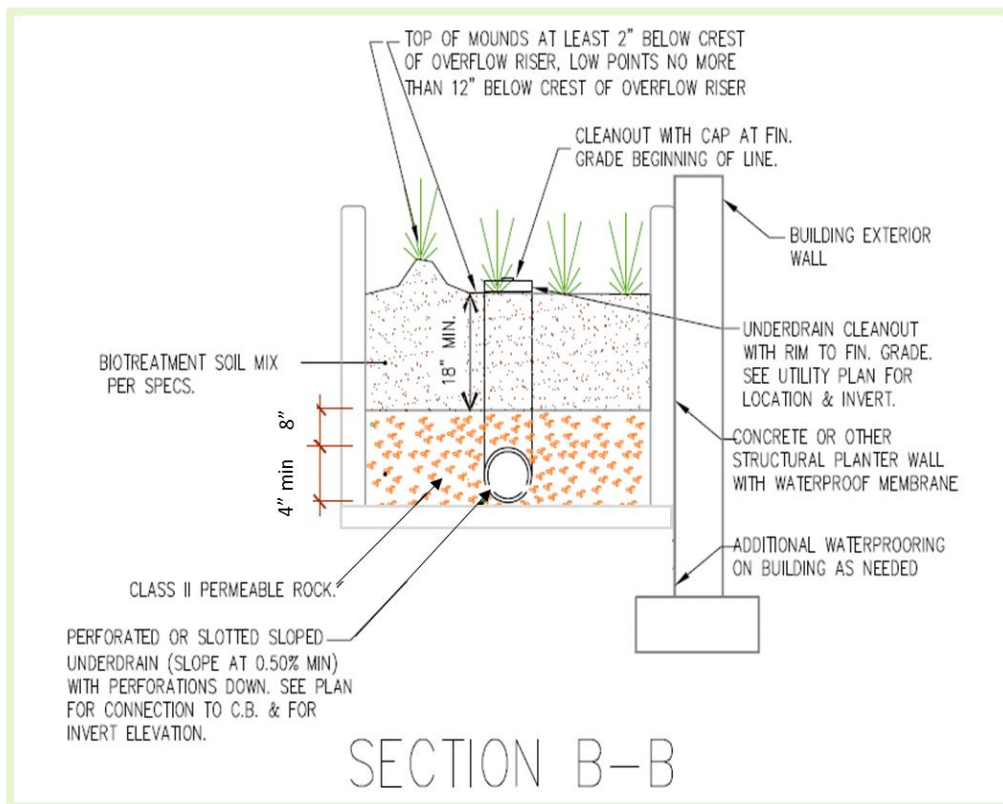


Figure 6-18: Cross section B-B of flow-through planter, shows cross section of underdrain

## 6.3 Tree Well Filter

### Overview

#### Description



#### Best uses

- Plazas, parks, roadways and parking lots where trees are desired.

#### Advantages

- Aesthetic
- Small footprint (in some designs)
- Blends with the landscape

#### Limitations

- Larger trees need more soil volume
- Higher installation cost
- Systems with high flow rate media are allowed *only in Special Projects*

Figure 6-19: Tree Well Filter (Credit: City of Menlo Park)

Tree well filters come in several types. They can be in boxes or open areas, with underground suspended pavement systems, or with proprietary high-flow rate media. Some tree well filters are in open-bottom systems that promote infiltration or in closed-bottom systems where infiltration is undesirable or infeasible, such as sites near structures, groundwater contamination, or high groundwater levels. Tree well filters are often installed along urban sidewalks as part of an integrated street landscape, but they are highly adaptable and can be used in most development scenarios. The top of the soil and mulch is set low enough that runoff from adjacent pavement can flow into the system. Tree well filters can also be constructed using suspended pavement system products (see Appendix A for guidance on suspended pavement systems).

A tree well filter's basic design is similar to that of a bioretention area or flow-through planter. It consists of an excavated pit or vault filled with biotreatment soil media, planted with a tree and sometimes with additional small plants, with Class 2 Permeable material and an underdrain. A tree well filter that uses biotreatment soil media and is designed for a stormwater runoff surface loading rate of 5 inches per hour is considered a LID treatment measure (either an infiltration or biotreatment measure, depending on its design). Suspended pavement systems can provide additional uncompacted soil volume for tree root growth under adjacent pavement areas as well as allowing for "underground" bioretention. If used as part of the stormwater treatment system, the areas under the pavement should be installed with the required minimum 18-inch depth of biotreatment soil media and underdrains as necessary.

High flow-rate tree well filters containing manufactured media with design loading rates greater than 5 inches per hour do not qualify as LID treatment measures and are only allowed for use in Special Projects, as described in Appendix J.

**Siting**

For strategies and examples of how to retrofit sites and parcels to include tree well filters, *see sections 3.2 and 3.3 of the GI Design Guide.*

Remember that stormwater control measures should be located in areas that can be accessible at any given time for the purpose of operation and maintenance and inspections. Tree well filters should not be located on inaccessible private property such as residential backyards.

When paired with suspended pavement systems and BSM, tree well filters can be considered LID and can sometimes fit into constrained spaces. They can prevent pavement damage and heaving from tree roots, reducing trip and fall hazards. See guidance in Appendix A for more information on providing increased soil volumes and integrating trees and stormwater measures. Figure 6-25 from the Ada County Highway District Stormwater Design Guidelines (from Boise, Idaho) shows a cross section detail for a street tree design with a suspended pavement system installed adjacent to the tree under a sidewalk, but the design can also be used in a parking lot or other paved areas on a private or public parcel.

Additional soil volumes can also be provided under pervious pavement systems. Pervious pavement allows the runoff to enter the suspended pavement system without a network of inlet pipes and can distribute the flow more evenly. The example in Figure 6-26 illustrates a location where a tree and a suspended pavement system is integrated into a project with pervious pavement. Three ways that trees, pervious pavement and suspended pavement systems can be integrated are:

1. Suspended pavement systems under pervious parking area pavement;
2. Suspended pavement systems under a pervious sidewalk adjacent to the tree planting areas; and/or
3. Suspended pavement systems under an adjacent roadway – typically a parking lane or gutter area.



*Figure 6-20: A tree well filter along a roadway (top – Credit: City of Fremont); and proprietary high flow rate tree well filters in a parking lot (bottom - Credit: City of Emeryville)*

*Table 6-5: Recommended locations for tree well filters*

Recommended Locations	Tree Well Filter
Parking Lot	●
Roof	
Driveway	●
Podium-level	
Close to building	●
Away from Buildings	●
Underground	●

## Design and Sizing Guidelines

### Treatment Dimensions and Sizing

- Flows in excess of the treatment flow rate should bypass the tree well filter to a downstream inlet structure or other appropriate outfall.
- Tree well filters cannot be placed in sump condition; therefore, tree well filters should have flow directed along a flow line of curb and gutter or other lateral structure. Do not direct flows directly to a tree well filter.
- Tree well filters with BSM (LID):
  - It is recommended that a tree well filter with a minimum 18" depth of BSM be sized to be 4% of the contributing impervious surface area; i.e., the area of impervious surface multiplied by the 0.04 sizing factor will equal the required surface area of the tree well filter. This sizing factor is derived from the flow-based treatment standard (runoff from 0.2 in./hr. intensity rainfall) and a required surface loading rate of 5 in./hr. Alternatively, if there are site constraints, tree well filter sizing may be calculated using a volume-based treatment method or a combination flow- and volume-based treatment method. Larger sized systems will allow for a larger tree species.
  - The number of trees to be provided will vary with the size of the treatment area and the size of the canopy of the expected tree species at maturity. It is recommended that a minimum of one tree for each 100 square feet of surface area be provided for smaller trees with increased spacing for larger tree species so that branches do not overlap. Smaller understory plants can provide treatment between trees when spacing exceeds 10 feet.
- High flow rate tree well filters (non-LID):
  - The system should be reviewed by the manufacturer/local supplier before installation. High flow rate tree well filters should be sized based on the loading rate of the media. The manufacturer should certify the ratio of impervious area to treatment area for the project.
  - The tree species will typically be of small stature due to the constrained box environment and lack of large volume of rootable soil. Larger boxes will allow for more soil volume and possibly increased tree health. Typically one to two trees per unit are used.
  - High flow rate tree well filters are available in multi-sized pre-cast concrete drop in boxes. Sizes range from 4 x 6-feet up to 6 x 12-feet boxes. The required size of the box is based on the size of the tributary impervious surface and the permeability of the filter media. The product must be certified by the Washington State Technical Assessment Protocol – Ecology (TAPE) program, General Use Level Designation (GULD) for Basic Treatment, and sized based on the certified design operating rate<sup>36</sup>.

### Inlets to Treatment Measure

- Flow may enter the treatment measure (see example drawings in Section 5.13):

<sup>36</sup> For more information, see: <https://ecology.wa.gov/Regulations-Permits/Guidance-technical-assistance/Stormwater-permittee-guidance-resources/Emerging-stormwater-treatment-technologies#tape>



- As overland flow from landscaping (no special requirements);
  - As overland flow from pavement (cutoff wall required);
  - Through a curb opening;
  - Through a curb drain;
  - With a drop structure through a stepped manhole (See Section 5.6);
  - Through a bubble-up manhole or storm drain emitter; and/or
  - Through a roof leader or other conveyance from building roof.
- Where flows enter the tree well filter, allow a change in elevation of 4 to 6 inches between the paved surface and the biotreatment soil media elevation, so that vegetation or mulch build-up does not obstruct flow.
  - Splash block, concrete aprons, grouted rock cobble, pea gravel rock mulch, or plants should be installed to dissipate flow energy where runoff enters the treatment measure.
  - Curb openings should be a minimum width of 18 inches (or 12" if allowed by the municipality) with the number and locations designed so that runoff is dispersed throughout the bioretention area or through the use of a flow spreading system.
  - Bubble-up emitters and pipes to bubble-up emitters should have weep holes to avoid standing water inside after storm events.



*Figure 6-21: Tree well filter with curb-cut inlet. This tree well filter also features an overflow bypass (Source: University of New Hampshire Environmental Research Group, 2006)*

### Vegetation

- Suitable tree species and general tree guidance is provided in Appendix A. Small-stature tree species are typically recommended for high flow rate tree well filters due to the small amount of soil volume available and the containerized system minimizing the connection to natural systems and stability. Larger-stature species can be used where increased soil volumes are provided.
- Use integrated pest management (IPM) and ReScape principles in the landscape design to help avoid or minimize any use of synthetic pesticides and quick-release fertilizer. Check with the local

jurisdiction for any local policies regarding the use of pesticides and fertilizers. See guidance in Appendix A for more details.

- Irrigation should be provided, as needed, to maintain plant life. If irrigation cannot be provided, then watering by hand should be accommodated weekly through plant establishment – typically through the first six months depending on the season and levels of precipitation.
- Trees and vegetation do not block inflow, create traffic or safety issues, or obstruct utilities.

### Soil and Drainage Requirements Specific to Tree Well Filters

- If the permeability of the media exceeds 5 inches per hour, use of the tree well filter is not considered LID and will not be allowed, except for Special Projects (see Appendix J).
- An underdrain system is required for tree well filters.

### Soil and Drainage Considerations for All Biotreatment Systems

- Consideration of groundwater level and placement of the underdrain:
  - If there is less than a 5-foot separation between the bottom of the facility and the seasonal high groundwater level, or infiltration is not allowed due to other site constraints, an impermeable liner should be placed between the Class 2 Perm and the bottom of the facility and the underdrain placed on top of that liner.
  - If there is at least a 5-foot separation between the bottom of the facility and the seasonal high groundwater level, and geotechnical conditions allow infiltration, the facility should be unlined and the underdrain should be raised at least 6 inches above the bottom of the Class 2 Perm to allow storage and infiltration of treated water.
- To avoid excess hydraulic pressure on subsurface treatment system structures:
  - The depth to seasonal high groundwater level should be at least 5 feet from the bottom of the structure.
- A geotechnical engineer should be consulted for situations where the bottom of the structure is less than 5 feet from the seasonal high groundwater level.
- Soil used in the tree well filter must meet the BASMAA biotreatment soil media (BSM) specification included in Appendix K if the project is a Regulated Project. Check with municipality for any additional requirements.
- An underdrain system is required where infiltration is not feasible or where it's limited.
- Filter fabric should not be used around the underdrain or between the BSM and the Class 2 Perm layer. Class 2 Perm performs the function of filter fabric (keeping the BSM from exiting the system through the underdrain) but is less prone to clogging.
- Install and maintain a 3-inch layer of composted wood mulch, consistent with the new regional Biotreatment Wood Mulch (BWM) specification<sup>37</sup> in areas between plantings and 6" away from tree trunks. Installing and maintaining a 3-inch layer of BWM is consistent with the State Water Efficient Landscape Ordinance (see Section 5.7 of this Guide for more details). Alternatively,

---

<sup>37</sup> See the [Biotreatment Wood Mulch specification](http://www.flowstobay.org/newdevelopment) on the Flowstobay website: [www.flowstobay.org/newdevelopment](http://www.flowstobay.org/newdevelopment)

biotreatment area sod<sup>38</sup>, that provides 100% soil coverage, or a 3-inch layer of rock mulch may be used. Keep sod at least 3 feet away from tree trunks (with mulch in that area) and rock mulch at least 6 inches away from tree trunks. However, rock mulch, such as cobble or gravel, should be used sparingly and only where absolutely necessary. “Micro-bark”, or “gorilla hair” mulches, as well as chipped wood mulch from recycled pallets and dimensional lumber, are not recommended. **See Sections 4.9 and 6.3 of the GI Design Guide** for more information on mulch.

- The underdrain should consist of a solid perforated or slotted HDPE or PVC pipe connected to a cleanout pipe(s) and to a storm drain or discharge point. Solid HDPE or triple-walled HDPE pipe, with smooth inner and outer layers and a corrugated middle layer, are recommended. The cleanout should consist of a vertical, rigid, non-perforated, non-corrugated PVC or HDPE pipe, with a minimum diameter of 4 inches and a watertight cap fit, raised or flush with the ground, or as required by municipality. There should be adequate fall (min. 0.5% slope) from the underdrain to the storm drain or discharge point. See Section 5.14 for more information on underdrains.
- The underdrain should be placed at the bottom of a 12-inch thick layer of Caltrans Class 2 permeable material, or similar municipality-approved material. See Section 5.14 for more information on Class 2 permeable material.

---

<sup>38</sup> Such as [Biofiltration Sod](#) from the Delta Blue Grass company.

### *Construction and Maintenance Plans*

#### Construction Requirements for All Biotreatment Systems

- Minimize compaction of existing soils if the system will be infiltrating water. Protect BSM and whole system from construction traffic and compaction.
- Protect the area from construction site runoff. Runoff from unstabilized areas should be diverted away from biotreatment facility.
- ***For additional construction guidelines, see Chapters 2, 4 and 5 of the GI Design Guide.*** Specifically, see **Sections 4.3 through 4.9** for construction strategies for dealing with slopes, overflows, poor soils, utilities, runoff capture, etc.

#### Remember

#### Maintenance Considerations for All Treatment Measures

- See Chapter 8 for specific maintenance guidance. Specifically, see Section 8.3.3 for maintenance concerns specific to tree well filters.
- A Maintenance Agreement should be provided and should state the parties' responsibility for maintenance and upkeep.
- Prepare a maintenance plan and submit with Maintenance Agreement. Maintenance plan templates are in Appendix G.

Typical Design Details

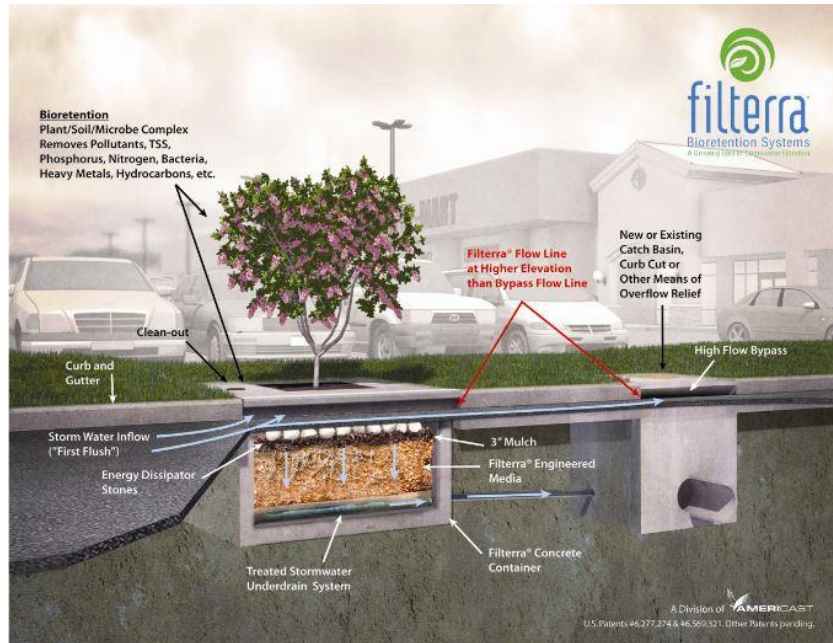


Figure 6-22: Cut Away View of a high-flow rate tree well filter- the use of this photo is for general information only and is not an endorsement of this or any other high flow rate stormwater treatment device. (Source: Contech Engineered Solutions, 2019).

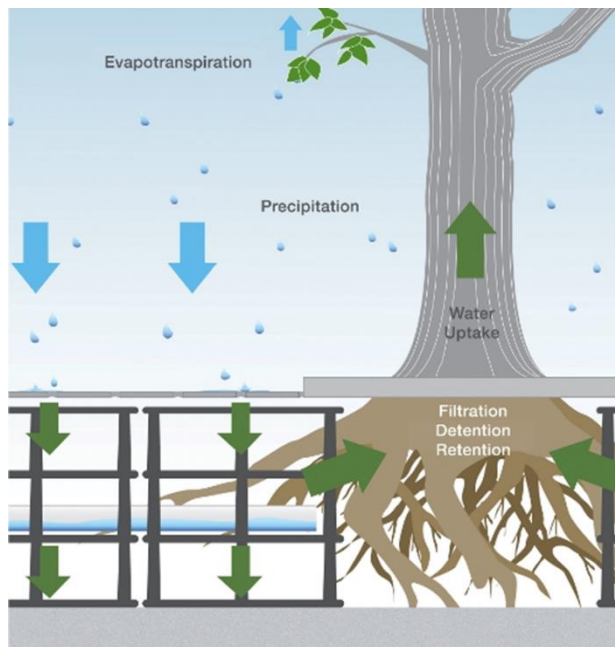


Figure 6-23: Schematic of modular suspended pavement system and a tree well filter. (Courtesy of: Deeproot Green Infrastructure, LLC).

## 6.3 Tree Well Filter

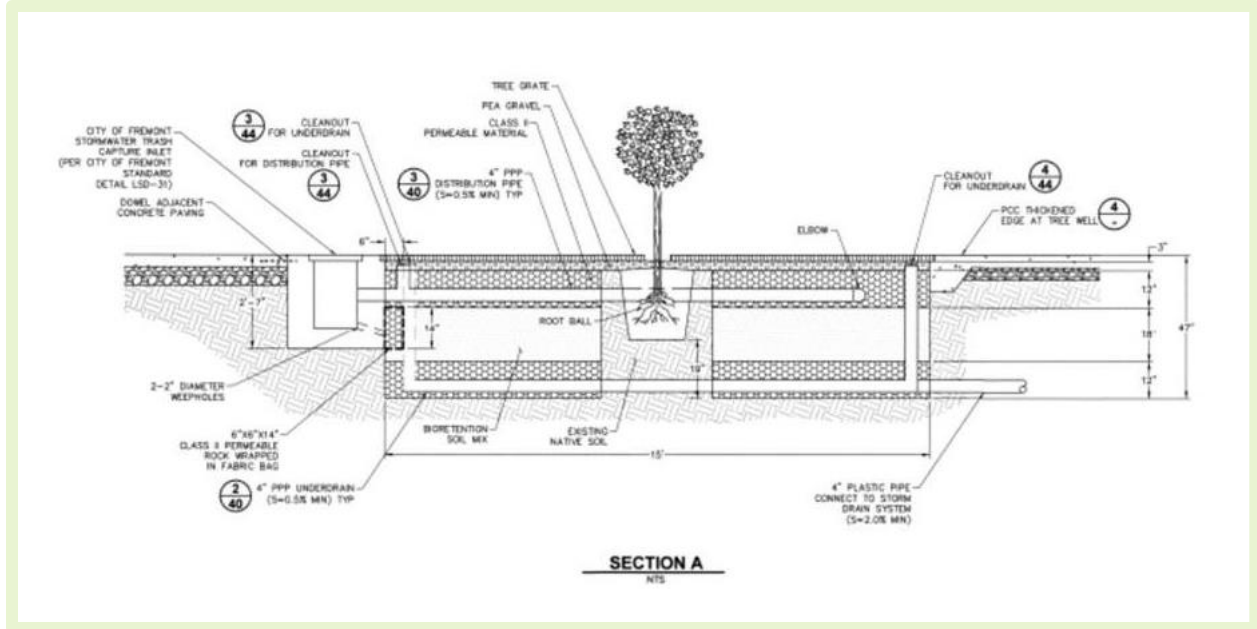


Figure 6-24: Cross Section Detail of a tree well filter with an integrated trash capture device (Credit: City of Fremont)

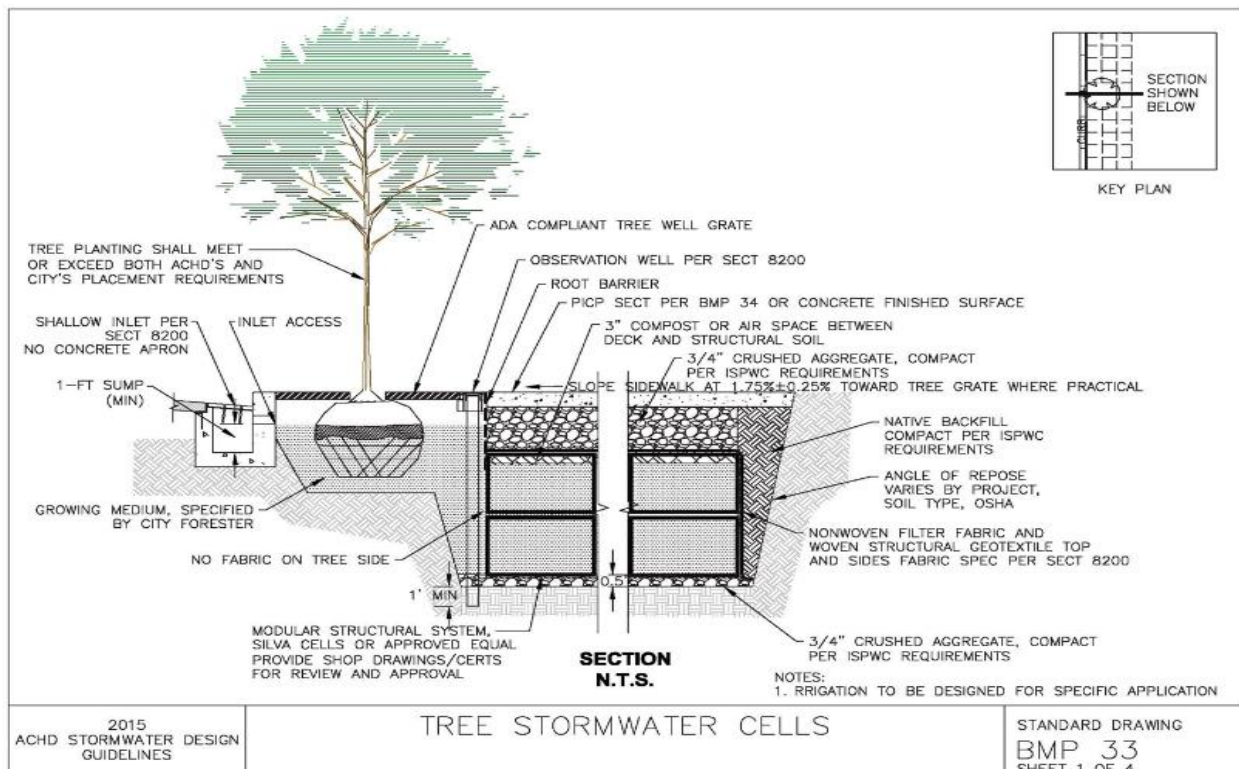


Figure 6-25: Cross Section Detail of a tree well filter with suspended pavement system installed under sidewalk (Credit: Ada County Highway District Stormwater Design Guidelines)

## 6.3 Tree Well Filter

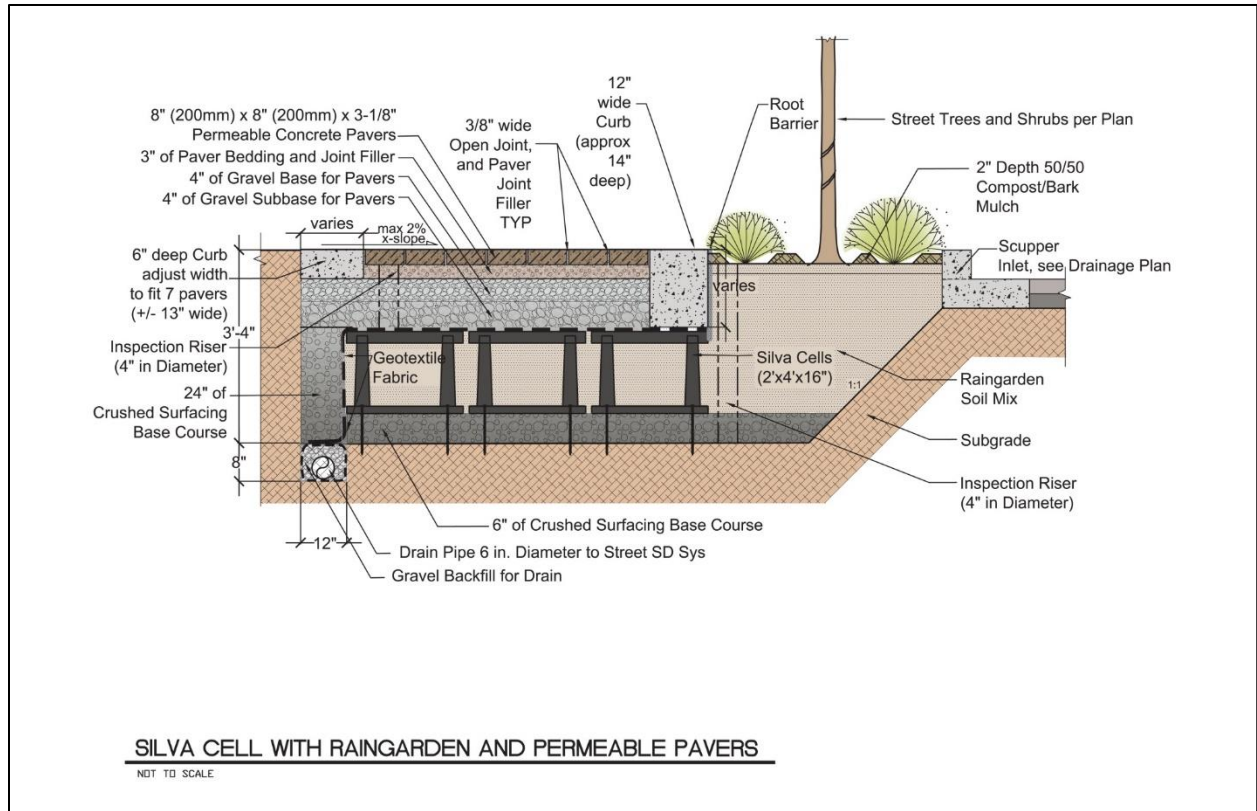


Figure 6-26: Cross Section detail of a tree well filter with Silva Cells under pervious pavement  
(Courtesy of: DeepRoot Green Infrastructure, [www.deeproot.com](http://www.deeproot.com))

## 6.4 Infiltration Trench

### Overview

#### Description

Infiltration trenches are appropriate in areas with well-drained (Type A or B) native soils. An infiltration trench is a long, narrow excavation backfilled with stone aggregate and lined with filter fabric. Runoff is stored in the void space between the stones and infiltrates through the bottom and into the soil matrix.



Figure 6-27. Infiltration Trench (Source: CASQA, 2003)

Note that this section primarily applies to shallow infiltration systems (that are wider than they are deep); for systems that are deeper than they are wide (such as infiltration wells) and subsurface infiltration systems, additional requirements may apply (see Section 6.11). For both shallow and deep system guidance on infiltration, refer to Appendix E.

Infiltration trenches perform well for removal of fine sediment and associated pollutants. Pretreatment using swales, vegetated filter strips or detention basins is important for limiting amounts of coarse sediment entering the trench, which can clog and render the trench ineffective. Infiltration practices, such as infiltration trenches, remove suspended solids, particulate pollutants, coliform bacteria, organics, and some soluble forms of metals and nutrients from stormwater runoff. Pollutants are filtered out of the runoff as it infiltrates the surrounding soils. Infiltration trenches can also provide groundwater recharge and preserve base flow in nearby streams.

#### Best uses

- Limited space
- Adjacent to paved surfaces
- Landscape buffers

#### Advantages

- May increase groundwater recharge
- Achieves treatment via infiltration into existing soils
- No surface outfalls

#### Limitations

- Susceptible to clogging if not maintained
  - leading to system failure
- Infiltration of soils must exceed 0.5 in./hr.
- Cannot be used with certain site conditions (see Appendix E)



### Siting

- Infiltration trenches should not be used where there are poorly draining soils, high groundwater tables, contaminated soils, fill soils, steep slopes, or in proximity to wells or septic systems.
- For strategies and examples of how to retrofit sites and parcels to include infiltration trenches, see **Sections 3.2 and 3.3 of the GI Design Guide**.
- Remember that stormwater control measures should be located in areas that can be accessible at any given time for the purpose of operation and maintenance and inspections. Infiltration trenches should not be located on inaccessible private property such as residential backyards.
- A permit may be required from San Mateo County Environmental Health if the system is more than 10 feet deep or if groundwater is encountered during excavation.<sup>40</sup>

*Table 6-6: Recommended locations for infiltration trenches*

Locations	Infiltration Trench
Parking Lot	●
Roof	
Driveway	●
Podium-level	
Close to building	
Away from Buildings	●
Underground	<sup>39</sup>

<sup>39</sup> Subsurface infiltration systems are covered in a separate section (see section 6.11)

<sup>40</sup> <https://www.smchealth.org/gpp>

## Design and Sizing Guidelines

### Drainage Area and Setback Considerations

- Infiltration trenches work best when the upgradient drainage area slope is less than 5 percent. The downgradient slope should be no greater than 20 percent to minimize slope failure and seepage.
- In-situ/undisturbed soils should have a low silt and clay content and have permeability greater than 0.5 inches per hour. In-situ testing is required to confirm permeability of trench site. Infiltration trenches are not recommended for use in Type C or D soils.
- A 10-foot separation between the bottom of the trench and the seasonal high groundwater level is required to prevent potential groundwater contamination.
- Trenches should also be located at least 100 feet upgradient from water supply wells.
- A setback of 18 feet from building foundations is recommended, or a 1:1 slope from the bottom of the foundation, unless a smaller setback is approved by geotechnical engineer and allowed by local standard.

### Treatment Dimensions and Sizing

- The infiltration trench should be sized to store and infiltrate the water quality design volume.
- A site-specific trench depth can be calculated based on the soil permeability, aggregate void space, and the trench storage time. The stone aggregate used in the trench is normally 1.5 to 2.5 inches in diameter, which provides a void space of 35 to 40 percent. A minimum drain time of 6 hours should be provided to ensure satisfactory pollutant removal in the infiltration trench, and a maximum of 48-72 hours drain time is required to ensure capacity for runoff from successive storm events. Trench depths are usually between 3 and 8 feet, with a depth of 8 feet most commonly used.
- The trench surface may consist of stone or pervious pavement with inlets to evenly distribute the runoff entering the trench. The basic infiltration trench design utilizes stone aggregate in the top of the trench to promote filtration; however, this design can be modified by substituting pea gravel for stone aggregate in the top 1-foot of the trench. Typically, there is about 35 to 40% void space within the rock.
- Use trench rock that is 1.5 to 2.5 inches in diameter or pea gravel to improve sediment filtering and maximize the pollutant removal in the top 1 foot of the trench.
- Place permeable filter fabric around the walls and bottom of the trench and 1 foot below the trench surface. The filter fabric should overlap each side of the trench in order to cover the top of the stone aggregate layer. The filter fabric prevents sediment in the runoff and soil particles from the sides of the trench from clogging the aggregate.
- An observation well is recommended to monitor water levels in the trench. The well can be 4 to 6-inch diameter PVC pipe, which is anchored vertically to a foot plate at the bottom of the trench.

### Inlet to the Treatment Measure

- Ideally runoff should enter the trench via sheet flow from the paved surface - spreading the flow. Runoff can be captured by depressing the trench surface or by placing a berm at the down gradient side of the trench. Underground inlets can also be used, but care must be taken to pretreat inflows to remove sediment to reduce the risk of clogging.
- To prevent clogging of the system with sediment, a vegetated buffer strip at least 5 feet wide, or other means of pretreatment, should be located adjacent to the infiltration trench to capture sediment particles in the runoff before runoff enters the trench. If a buffer strip or swale is used, installation should occur immediately after trench construction, using sod instead of hydroseeding to prevent erosion. The buffer strip should be graded with a slope between 0.5 and 1.5 percent so that runoff enters the trench as sheet flow.
- If runoff is piped or channeled to the trench, a level spreader should be installed to create sheet flow.

### Vegetation

- Infiltration trenches should be kept free of vegetation. If vegetation on the surface is desired, a different treatment measure (e.g., linear bioretention area) should be selected.
- To avoid accumulation of leaves and other debris that can lead to sediment production and clogging, trees and other large vegetation should be planted away from trenches such that drip lines do not overhang infiltration beds.

### *Construction and Maintenance Plans*

#### Construction Requirements

- If the area tributary to the infiltration trench contains disturbed soil or stockpiles, it must be fully developed, stabilized and protected from erosion with vegetation, temporary pavement, liners or rock mulch before constructing the infiltration trench. High sediment loads from unstabilized or protected areas will quickly clog the infiltration trench. During project construction, runoff from unstabilized or protected areas should be diverted away from the infiltration trench into a sedimentation control BMP until the final tributary area landscaping or other non-erosive surface is established.
- When excavating, avoid spreading fines of the soils on bottom and sides. Remove any smeared soiled surfaces and provide a natural soil interface into which water may percolate.
- Minimize compaction of existing soils. Protect from construction traffic.
- ***For additional construction guidelines, see Chapter 4 of the GI Design Guide.*** Specifically, see Sections 4.3 through 4.9 of the GI Design Guide for construction strategies for dealing with slopes, overflows, poor soils, utilities, runoff capture, etc.

#### Remember

#### Maintenance Considerations for All Treatment Measures

- See Chapter 8 for specific maintenance guidance. Specifically, see Section 8.3.4 for maintenance concerns specific to infiltration trenches.
- A Maintenance Agreement should be provided and should state the parties' responsibility for maintenance and upkeep.
- Prepare a maintenance plan and submit with Maintenance Agreement. Maintenance plan templates are in Appendix G.

Typical Design Details

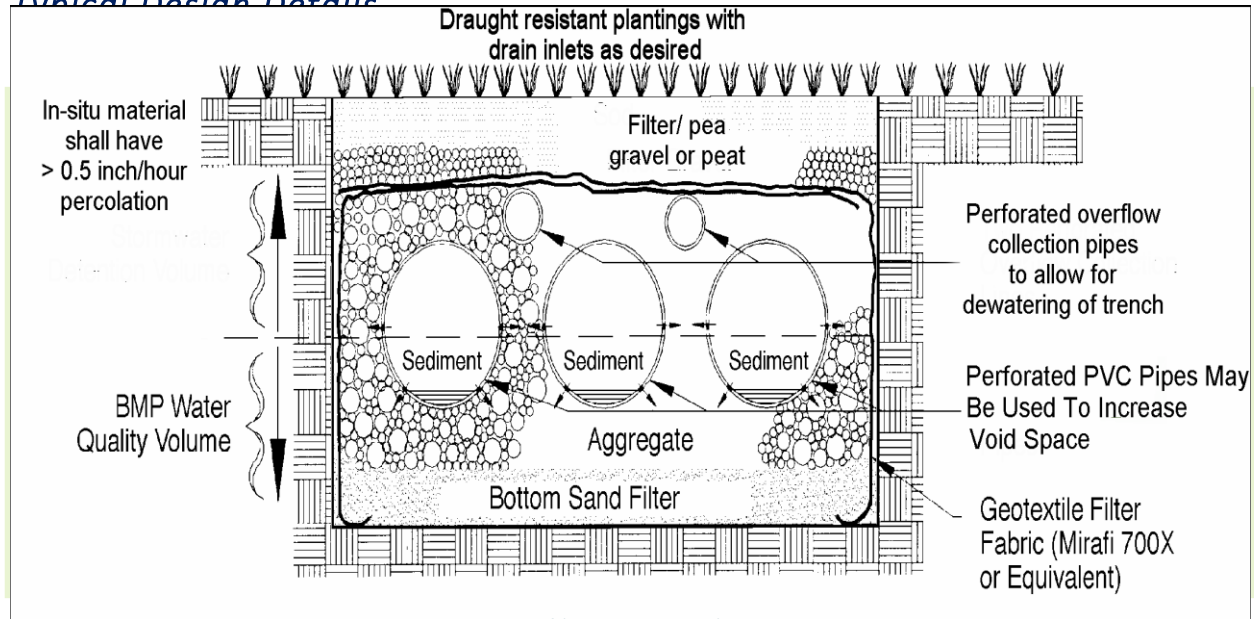


Figure 6-28: Infiltration trench cut-away view

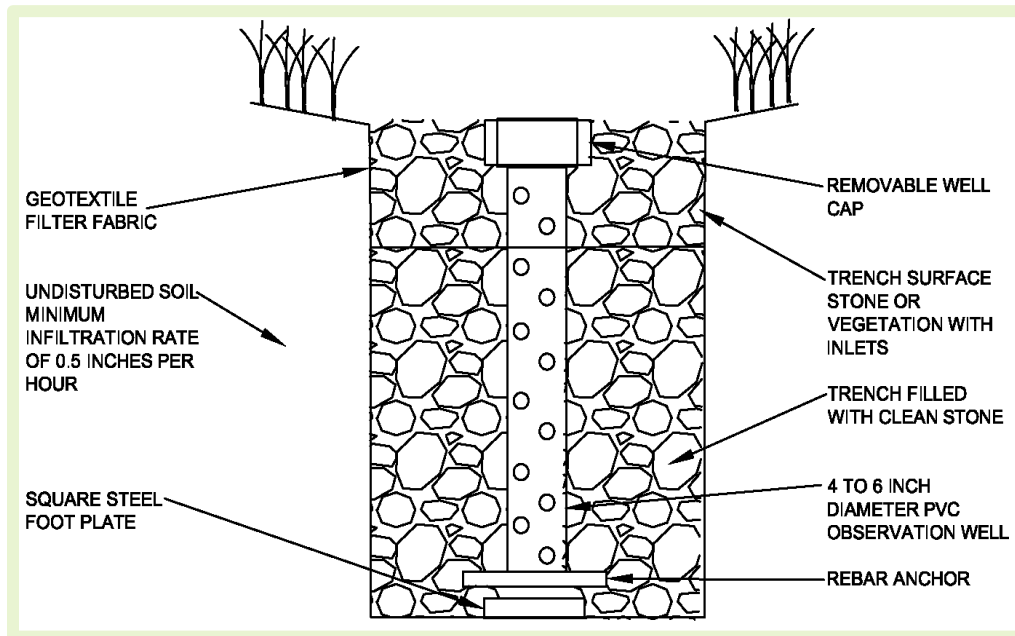


Figure 6-29: Cutaway view: Infiltration Trench with Observation Well

## 6.5 Extended Detention Basin

### Overview

#### Description

Extended detention ponds (a.k.a. dry ponds, dry extended detention basins, detention ponds) are basins whose outlets have been designed to detain the stormwater runoff from a water quality design storm for some minimum time (e.g., 48 hours) to allow particles and associated pollutants to settle. Unlike wet ponds, these facilities do not have a permanent pool. They can also be used to provide flood control by including additional flood detention storage above the treatment storage area.



Figure 6-30: Extended Detention Basin. (Courtesy of DES Architects and Engineers)

**As of December 1, 2011**, projects can no longer meet stormwater treatment requirements with stand-alone extended detention basins that are designed to treat stormwater through the settling of pollutants and gradual release of detained stormwater through an orifice. However, this type of extended detention basin could be used as part of a treatment train, in which the basin stores a large volume of water, which is gradually released to a bioretention area that meets the new MRP requirements for biotreatment soil media and surface loading area. Detention basins can also be used for hydromodification management.

#### Best uses

- Detain low flows
- Can be expanded to detain peak flows
- Sedimentation of suspended solids
- Pre-treatment

#### Advantages

- Easy to operate
- Inexpensive to construct
- Treatment of particulates
- Low maintenance

#### Limitations

- Storage area available
- Moderate pollutant removal
- Not considered LID treatment

## Siting

Remember that stormwater control measures should be located in areas that can be accessible at any given time for the purpose of operation and maintenance and inspections.

*Table 6-7: Recommended locations for extended detention basins areas*

Recommended Locations	Extended Detention Basin
Parking Lot	
Roof	
Driveway	
Podium-level	
Close to building	
Away from Buildings	●
Underground	

## Design and Sizing Guidelines

### Treatment Dimensions and Sizing

- Extended detention basins should be sized to capture the required water quality volume and store and release it over a 48-hour period. At least 10 percent additional storage should be provided to account for storage lost to deposited sediment.
- Extended detention basins should have no greater than 3:1 side slope.
- The optimal basin depth is between 2 and 5 feet.
- A safety bench should be added to the perimeter of the basin wall for maintenance when basin is full.
- Extended detention basin should empty within five days to avoid vector generation.
- A 12-foot wide maintenance ramp leading to the bottom of the basin and a 12-foot wide perimeter access road should be provided. If not paved, the ramp should have a maximum slope of 5 percent. If paved, the ramp may slope 12 percent.
- The extended detention basin should have a length to width ratio of at least 1.5:1.
- A fixed vertical sediment depth marker should be installed in the sedimentation forebay. The depth marker should have a marking showing the depth where sediment removal is required. The marking should be at a depth where the remaining storage equals the design water quality volume.
- Extended detention basins are not designed to infiltrate the entire volume of water captured, but they may infiltrate some water if conditions allow.
- For sizing information relative to hydromodification management, refer to Chapter 7.

### Inlets to Treatment Measure

- The inlet pipe should have at least 1 foot of clearance to the basin bottom.
- Piping into the extended detention basin should have erosion protection. As a minimum, a forebay with a 6-inch thick layer of Caltrans Section 72, Class 2 rock slope protection should be placed at and below the inlet to the extent necessary for erosion protection.
- Check with municipality regarding trash screen requirements. Trash screen installation may be required upstream of the pipe conveying water into the pond, in order to capture litter and trash in a central location where it can be kept out of the pond until it is removed.



## Outlets and Orifices

- The outlet should be sized with a drawdown time of 48 hours for the design water quality volume. The outlet should have two orifices at the same elevation sized using the following equation:

$$a = (7 \times 10^{-5}) * A * (H - H_o)^5 / CT$$

Where:

a = area of each orifice in square feet

A = surface area of basin at mid-treatment storage elevation (square feet)

H = elevation of basin when filled by water treatment volume (feet)

H<sub>o</sub> = final elevation of basin when empty (bottom of lowest orifice) (feet)

C = orifice coefficient (0.6 typical for drilled orifice)

T = drawdown time of full basin (hours)

(Caltrans Method, Appendix B, Stormwater Quality Handbook, September 2002)

- The orifices should each be a minimum diameter of 1 inch. Extended detention basins are not practical for small drainage areas because the minimum orifice diameter cannot be met.
- Each orifice should be protected from clogging using a screen with a minimum surface area of 50 times the surface area of the openings to a height of at least 6 times the diameter. The screen should protect the orifice openings from runoff on all exposed sides.
- For each outlet, documentation should be provided regarding adequacy of outlet protection. A larger stone size may be necessary depending on the slope and the diameter of the outfall.

## Vegetation

- Plant species should be adapted to periods of inundation. See planting guidance in Appendix A.
- Use integrated pest management (IPM) principles in the landscape design to help avoid or minimize any use of synthetic pesticides and quick-release fertilizer. Check with the local jurisdiction for any local policies regarding the use of pesticides and fertilizers.
- Irrigation should be provided as needed to maintain plant life.
- If vegetation is not established by October 1st, sod should be placed over loose soils. Above the area of inundation, a 1-year biodegradable loose weave geofabric may be used in place of sod.

## Groundwater Separation Considerations

- Consideration of groundwater level:
  - If there is less than a 5-foot separation between the bottom of the facility and the seasonal high groundwater level, or infiltration is not allowed due to other site constraints, an impermeable liner should be placed at the bottom of the facility.
  - If there is at least a 5-foot separation between the bottom of the facility and the seasonal high groundwater level, and geotechnical conditions allow infiltration, the facility may be unlined.

### *Construction and Maintenance Plans*

#### Construction Considerations

- The GI Design Guide does not cover extended detention basins. However, some construction guidelines developed for other infiltration measures might apply to detention basins.
- ***For general construction guidelines, see Chapter 4 the GI Design Guide.*** Specifically, see Sections 4.3 through 4.9 of the GI Design Guide for construction strategies for dealing with slopes, overflows, poor soils, utilities, runoff capture, etc.

#### Remember

#### Maintenance Considerations for All Treatment Measures

- See Chapter 8 for specific maintenance guidance. Specifically, see Section 8.3.5 for maintenance concerns specific to detention basins.
- A Maintenance Agreement should be provided and should state the parties' responsibility for maintenance and upkeep.
- Prepare a maintenance plan and submit with Maintenance Agreement. Maintenance plan templates are in Appendix G.

Typical Design Details

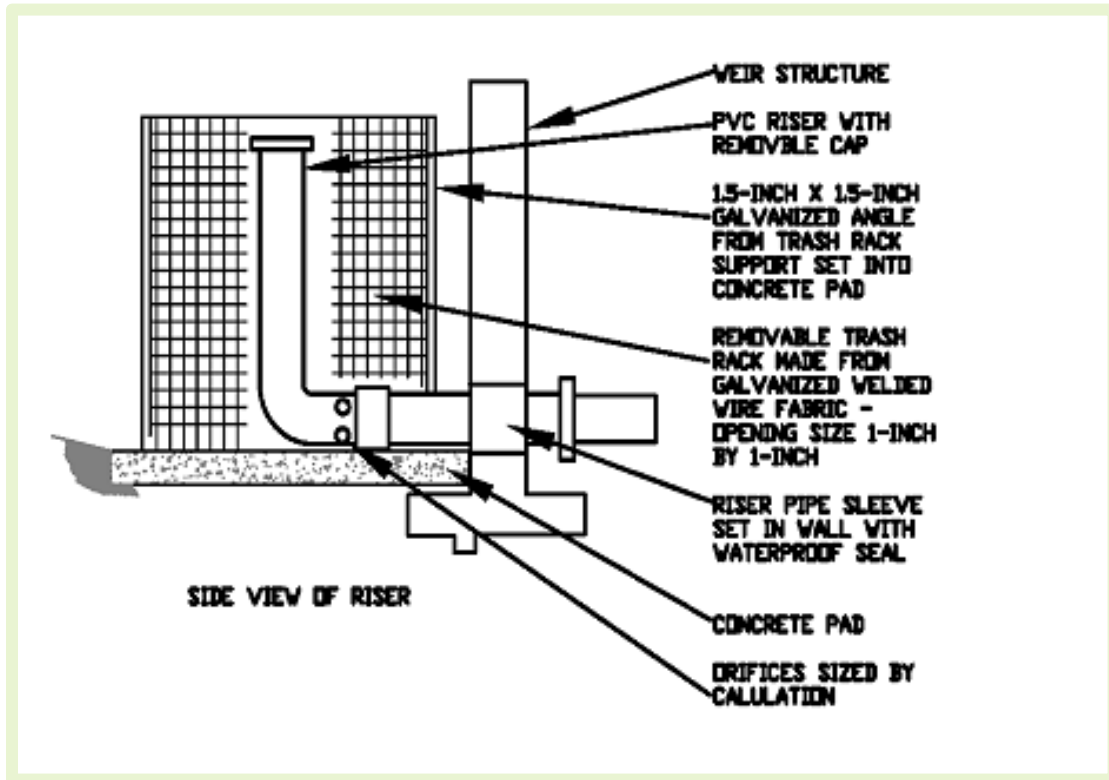


Figure 6-31. Side View of Riser

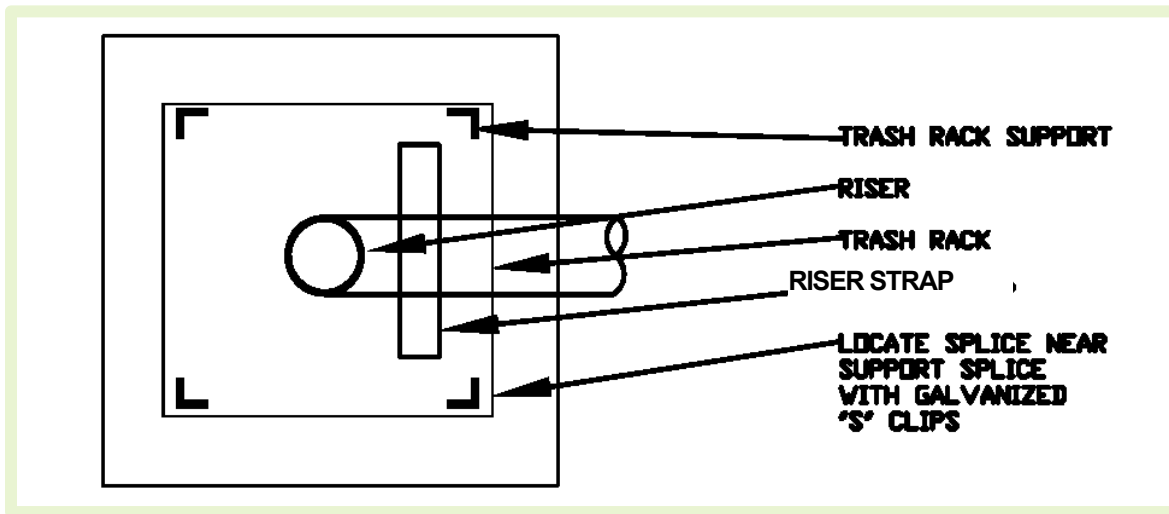


Figure 6-32. Top View of Riser (Square Design)

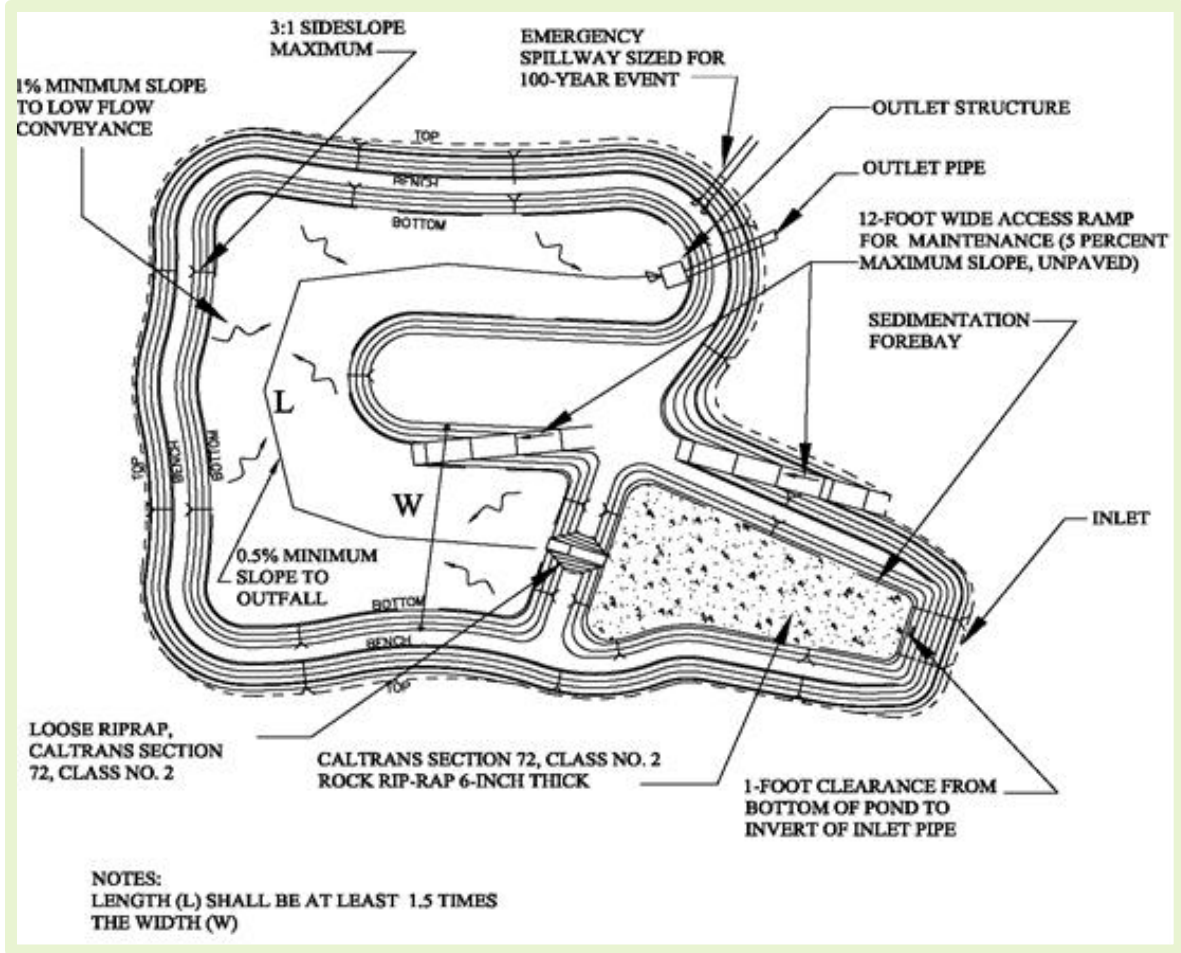


Figure 6-33. Plan View, Typical Extended Detention Basin

## 6.6 Pervious Pavement

### Overview

#### Description



Figure 6-34: The City of Menlo Park used pervious concrete for parking stalls and standard paving in the drive aisles in this public parking lot. (Credit: City of Menlo Park)

Pervious pavement types include pervious concrete, porous asphalt, permeable pavers and pervious pavers. Pervious pavers allow infiltration through the paver while permeable pavers utilize the joint space between the pavers for infiltration. Except for permeable pavers, pervious pavement is generally used for areas with light vehicle loading, such as vehicle parking stalls and drive aisles, parking lanes on streets, access/maintenance roads, overflow parking lots, sidewalks, pedestrian plazas, cycling facilities and walking paths. Table 6-9 shows possible applications for different types of pervious pavement. Figures 6-35 through 6-40 provide more detailed design information as well as in the GI Design Guide. The term pervious pavement describes a system comprised of a load-bearing, durable surface constructed over a subbase of various layers of compacted, open-graded aggregates. The layers temporarily store water prior to infiltration or drainage to a controlled outlet. The surface must be porous and allow water to infiltrate through the material, or into the joints. ***If an area of pervious pavement is underlain with pervious storage material, such as a layer of aggregate sufficient to hold at least the C.3.d amount of runoff, and allows for infiltration into native soil, it is not considered an impervious surface and can function as a self-treating or self-retaining area, as described in Section 4.2.*** Note that this applies to projects that use pervious pavement to reduce the impervious surface area to below the C.3 Regulated Projects threshold. ***Pervious pavement treatment systems must include infiltration into native soil to be considered LID.***

Please note that the CALGreen Building Code does not define pervious pavement in the same way as the MRP. Projects that include pervious pavement per CALGreen requirements must also verify that the pervious pavement meets the MRP definition of pervious pavement.

#### Best uses

- Light traffic roads and alleys, parking lots, driveways, bike lanes, sidewalks, and plazas
- Where space is limited for Biotreatment

#### Advantages

- Flow/volume reduction
- Provides treatment via infiltration into soil
- Reduces need for other treatment measures

#### Limitations

- May clog without periodic cleaning
- Higher installation costs than conventional pavement

The Countywide Program gratefully acknowledges the contributions of Mr. David Smith, formerly Technical Director of the Interlocking Concrete Pavement Institute, to this section of the Guide, including pavement sections, design details, and specifications.

**Siting**

For strategies and examples of how to retrofit streets and sites to include pervious pavement, *see Sections 3.2 and 3.3 of the GI Design Guide.*

Contrary to most other treatment measures, small areas of pervious pavement do not need as much maintenance so they can be located in remote sections of private property such as backyards and pathways. However, if the areas total 3,000 sq. ft. or more, they are considered regulated treatment systems (meaning they require an O&M agreement) and require municipal inspection at least once every five years. Therefore, they should only be constructed in front yards, driveways, parking lots and other areas visible from the public right of way so that municipal inspectors can see and verify the existence of the systems.

*Table 6-8: Recommended locations for pervious pavement areas*

Recommended Locations	Pervious Pavement
Parking Lot	●
Roof	
Driveway	●
Podium-level	
Close to building	
Away from Buildings	●
Underground	

Table 6-9: Types of Pervious Pavement and Possible Applications

Paver Type	Description	Possible Applications
<b>Porous Asphalt</b>	Open-graded asphalt concrete over an open-graded aggregate base, over a draining soil. Contains very little fine aggregate (dust or sand) and is comprised almost entirely of stone aggregate and asphalt binder; surface void content of 12-20%.	Low traffic use, such as parking lots, travel lanes, parking stalls. Surface may be too rough for some applications.
<b>Pervious Concrete</b>	Typically a cast-in-place discontinuous mixture of coarse aggregate, hydraulic cement and other cementitious materials, admixtures, and water which have a surface void content of 15-25% allowing water to pass through. Also available in pre-cast units of variable sizes.	Sidewalks and patios; low traffic volume; low speed (less than 30 mph limit) and lighter load roadways; bikeways; parking stalls; gutters; and residential driveways.
<b>Permeable Pavers</b>	Discrete units set in a pattern on a prepared base. Typically made of precast concrete in shapes that form interlocking patterns. Solid unit pavers are made of impermeable materials but are spaced to expose a permeable joint filled with permeable aggregates and set on a permeable base.	All uses: parking lanes, stalls and lots, private driveways, bikeways, walkways, patios, alleys, public and private roadways.
<b>Pervious Pavers</b>	Discrete units set in a pattern on a prepared base. Constructed of permeable concrete to allow water to flow through the paver. Can be set adjacent to other pavers with no joint space required.	Lighter traffic areas such as walkways, bikeways and vehicle parking areas.
<b>For more information on the use of pervious pavement in roadway projects, see Section 2.6 of the GI Design Guide.</b>		

### *Design and Sizing Guidelines*

The design of each layer of the pavement must be determined by the likely traffic loadings and the layer's required operational life. The thickness of the base layer is also affected by hydrologic sizing considerations. To provide satisfactory performance, the following criteria should be considered.

#### Subgrade and Site Requirements

- The soil sub-grade should be able to sustain anticipated traffic loading without excessive deformation while temporarily saturated.
- The sub-grade should be either ungraded in-situ material with a permeability that allows detained flows to infiltrate within 72 hours, or the pavement system can be installed with an underdrain that will remove detained flows within the pervious pavement and base.
- Depth to seasonal high groundwater level should be at least 5 feet from the bottom of the base of the pervious pavement system, unless a different separation is recommended by the geotechnical engineer.
- Pervious pavement systems should not be used where site conditions do not allow infiltration. Grading of the soil subgrade below the pervious pavement should be relatively flat (not to exceed 2% slope) to promote infiltration across the entire area.
- A slope of 1% is recommended for pervious pavement surfaces. Slopes of subgrades for pervious pavement should not exceed 5% but can be sloped up to 16%<sup>41</sup> when constructed with underdrains and check dams. Slopes of subgrades exceeding 3% typically require berms or check dams placed laterally over the soil subbase to slow the flow of water and provide some infiltration. Alternatively, pervious pavement systems can be terraced to step down a steep slope, maintaining level bed bottoms separated by berms. More details on subgrade slopes and check dams can be obtained by going to the Sustainable Street Typical GI Details in the GI Design Guide, or see Detail PC 2.2 in Figure 6-40 in the typical details section below.

#### Base Layer

- To allow for subsurface water storage, the base must be open graded, crushed stone (not pea gravel), meaning that the particles are of a limited size range, with no fines, so that small particles do not choke the voids between large particles.
- When subject to vehicular traffic, all open-graded aggregates should conform to the following or to similar specifications as directed by the municipality: crushed material, minimum 90% with at least 2 fractured faces conforming to Caltrans test method CT 205; have Los Angeles Rattler no greater than 40% loss at 500 revolutions per Caltrans test method CT 211; and a minimum Cleanness value of 75 per Caltrans test method CT 211. Sieve analysis should conform to Caltrans test method CT 202.
- If the subbase/base layer is sized to hold and infiltrate at least the C.3.d amount of runoff, the area of pervious pavement is not considered an impervious surface and can function as a self-treating area (see Section 4.2).

---

<sup>41</sup> <https://www.perviouspavement.org/design/hydrological.html>



- If the subbase/base layer has sufficient capacity in the void space to store the C.3.d amount of runoff (volume) for both the area of pervious pavement and the area that drains to it, it is not considered an impervious surface and can function as a self-retaining area, described in Section 4.2.
- Pervious pavement designed to function as a self-retaining area may accept runoff from an area of impervious surface that has a surface area of up to two times the surface area of the properly designed pervious pavement area.
- If an underdrain is used, position the perforated pipe within the subgrade enveloped on all sides by a least 4 inches of open-graded aggregate and provide a non-perforated, upturned elbow pipe for outflows (see Figures 6-26 and 6-27.) A cleanout with surface access is recommended at the upturn. To be considered a self-treating area or self-retaining area, the underdrain should be positioned above the portion of the base layer that is sized to meet the C.3.d sizing criteria.
- Design calculations for the base should quantify the following:
  - Soil type/classification and soil permeability rate; if subject to vehicular traffic, k-values (psi/cubic inch) or R-values characterizing soil strength when saturated;
  - Fill type if used, installation, and compaction methods plus target densities;
  - Lifetime expected vehicular traffic loading (in 18,000 lb. equivalent single axle loads or Caltrans Traffic Index); the maximum Traffic Index = 9.
  - Drainage routing of detained flows within the open graded subbase/base as well as expected infiltration into in-situ soils, or collection in a raised underdrain if the permeability cannot meet design criteria.

### Pavement Materials

- The pavement materials should not crack or suffer excessive rutting under anticipated traffic loads. This is controlled by designing pervious concrete and porous asphalt surfacing materials and layer thicknesses that minimize the horizontal tensile stress at their base. All pervious pavements benefit from using open-graded aggregate base materials with sufficient thicknesses and compaction that spread and minimize applied vertical stresses from vehicles.
- Pervious concrete and porous asphalt materials require narrow aggregate grading to create open voids in their surfaces. Materials choice is therefore a balance between stiffness in the surface layer and permeability. Permeable pavers require similar types of aggregate (without cement or asphalt) placed in the joints, typically ASTM No. 8, 89, or 9 stone depending on the paver joint widths. Refer to industry association literature for grading recommendations for all surfaces.
- Permeable paver units should conform to the dimensional tolerances, compressive strengths and absorption requirements in ASTM C936. Paver units subject to vehicular traffic should be at least 3 1/8 in. thick and have a length to thickness ratio not exceeding 3.

## Construction and Maintenance Plans

### Design and Installation

- All designs should be reviewed and approved by a licensed civil or geotechnical engineer or as directed by the municipality.
- Design for pervious concrete should be reviewed by the concrete manufacturer or National Ready Mixed Concrete Association (NRMCA) ([www.nrmca.org](http://www.nrmca.org)), or as directed, the municipality. Consult Portland Cement Association publication, *Hydrologic Design of Pervious Concrete* (2007) available from [www.cement.org](http://www.cement.org).
- Design for porous asphalt should be reviewed by the asphalt manufacturer, the National Asphalt Pavement Association (NAPA) ([www.porousasphalt.net](http://www.porousasphalt.net)), or as directed by the municipality. Consult NAPA publication, *Porous Asphalt for Stormwater Management* (2008) for additional information on design, construction, and maintenance.
- Design for permeable pavers should be reviewed by the concrete paver manufacturer, the Interlocking Concrete Pavement Institute (ICPI) ([www.icpi.org](http://www.icpi.org)), or as directed by the municipality. Consult ICPI publication, *Permeable Interlocking Concrete Pavements* 4<sup>th</sup> Edition (2012) for additional information on design, construction and maintenance. [www.icpi.org/node/2750](http://www.icpi.org/node/2750)
- Installation of pervious concrete, porous asphalt, pervious pavers and permeable pavers should be done by contractors who have constructed projects similar in size to that under consideration.
- For poured-in-place pervious concrete, only contractors with certification from NRMCA should be considered, and such contractors should have at least one foreman with this certification on the job site at all times. More information can be found at: [www.concretoparking.org/pervious/index.html](http://www.concretoparking.org/pervious/index.html) and [www.bayareaperviousconcrete.com](http://www.bayareaperviousconcrete.com)
- For permeable pavers, it is recommended that only contractors holding a record of completion in the Interlocking Concrete Pavement Institute's PICP Installer Technician Course should be considered and such contractors should have at least one foreman with this certificate on the job site at all times. More information can be found at [www.icpi.org](http://www.icpi.org).
- All new pervious concrete and porous asphalt pavements should have a minimum surface permeability of 100 in./hr. when tested in accordance with ASTM C1701. Permeable pavers should have a minimum surface permeability of 100 in./hr. when tested in accordance with ASTM C1781. Test results using both methods are comparable.
- Protect excavated area from excessive compaction due to construction traffic and protect the finished pavement from construction traffic.
- Additional design resources can be found on: <https://dot.ca.gov/programs/design/hydraulics-stormwater>.
- **For additional construction guidelines, see Chapter 4 of the GI Design Guide.** See Section 4.10 of the GI Design Guide for construction strategies specific to pervious pavement.

### Remember

#### Maintenance Considerations

- See Chapter 8 for specific maintenance guidance. Specifically, see Section 8.3.6 for maintenance concerns specific to pervious pavement.
- A Maintenance Agreement should be provided for Regulated Projects with installations totaling 3,000 square feet or more of pervious pavement.
- The Maintenance Agreement should state the parties' responsibility for maintenance and upkeep.
- Prepare a maintenance plan and submit with the Maintenance Agreement. Maintenance plan templates are in Appendix G.

Typical Design Details

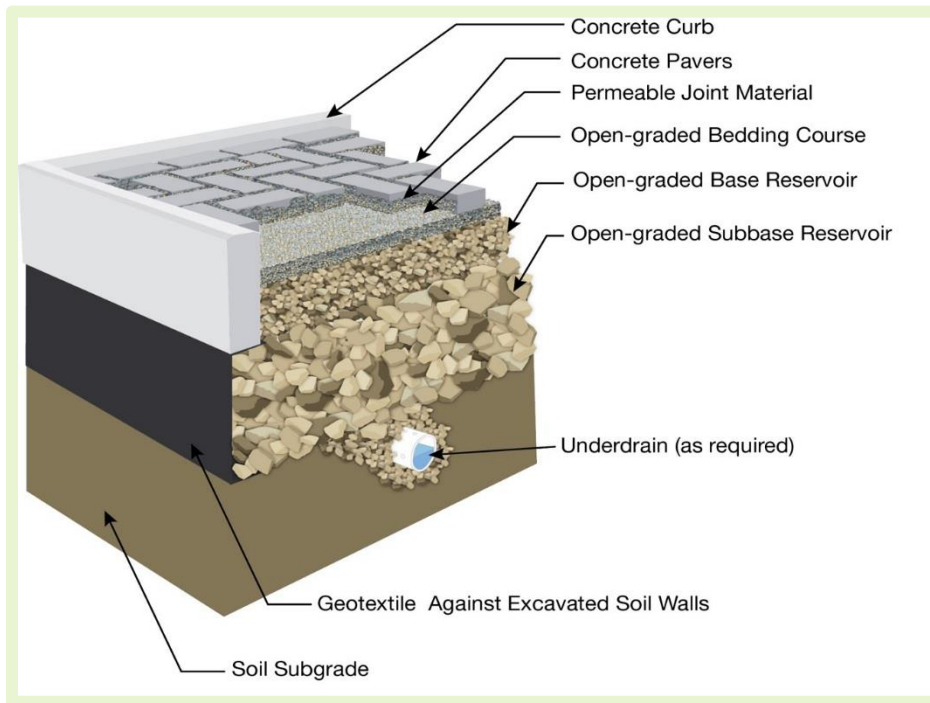


Figure 6-35. Permeable pavers designed for partial infiltration, with underdrain (Credit: Interlocking Concrete Pavement Institute)

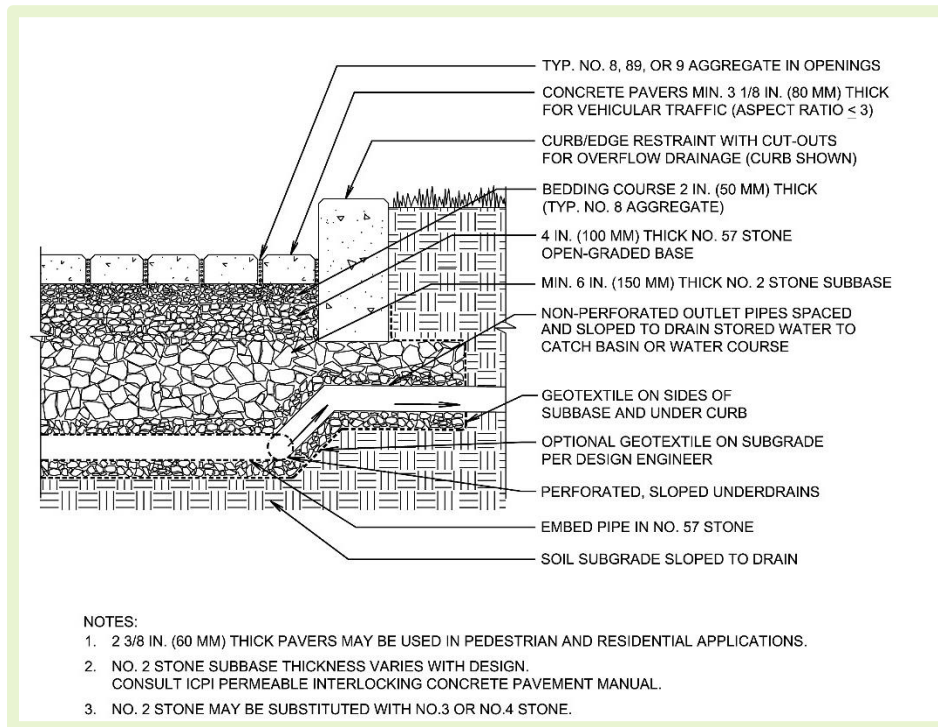


Figure 6-36. Permeable pavers with detail of underdrain in aggregate trench with upturned elbow (Credit: ICPI)

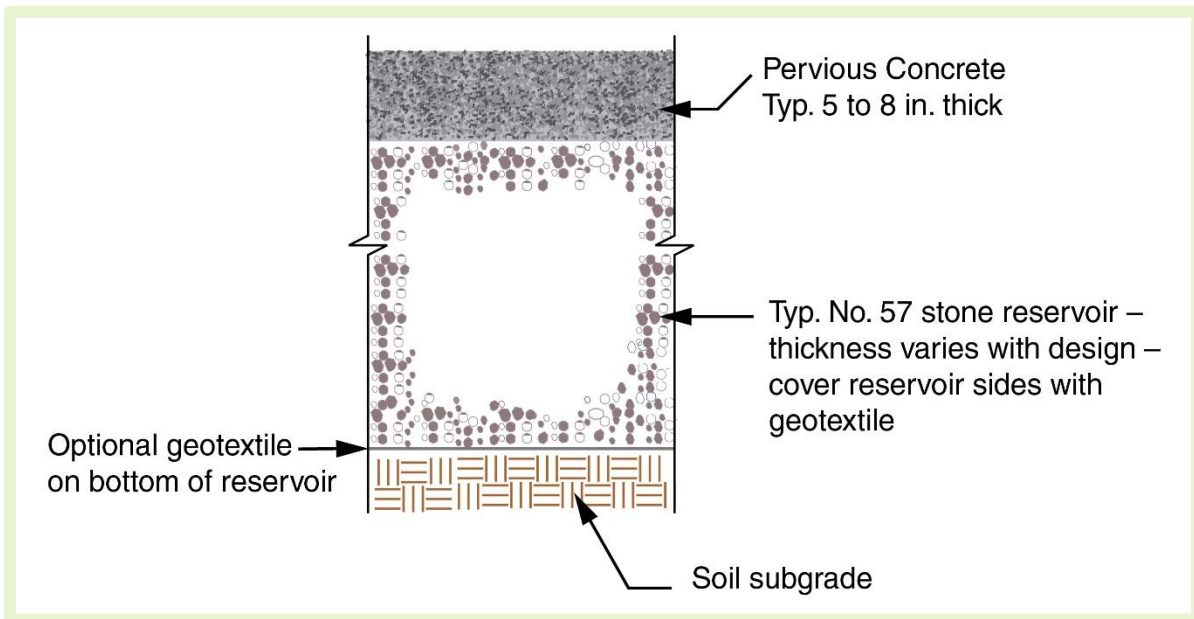


Figure 6-37. Typical Pervious Concrete Pavement (Credit: ICPI)

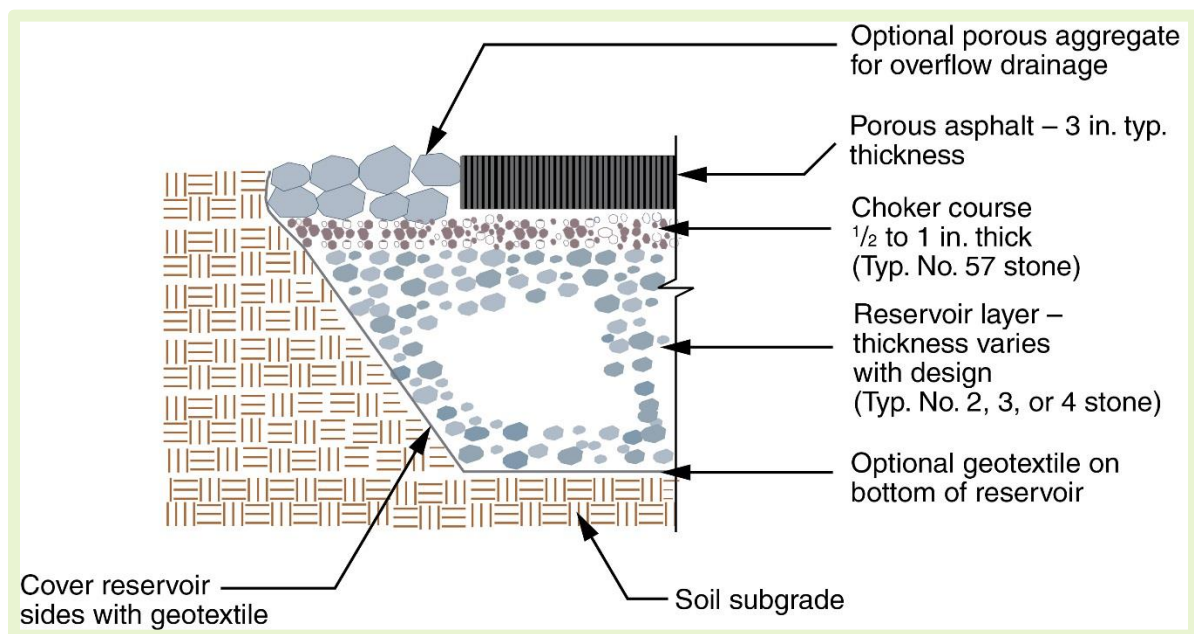


Figure 6-38. Typical Porous Asphalt Pavement Section (Credit: ICPI)

Note: ASTM No. 3 or 4 stone may be substituted for No. 2 stone.

## 6.6 Pervious Pavement

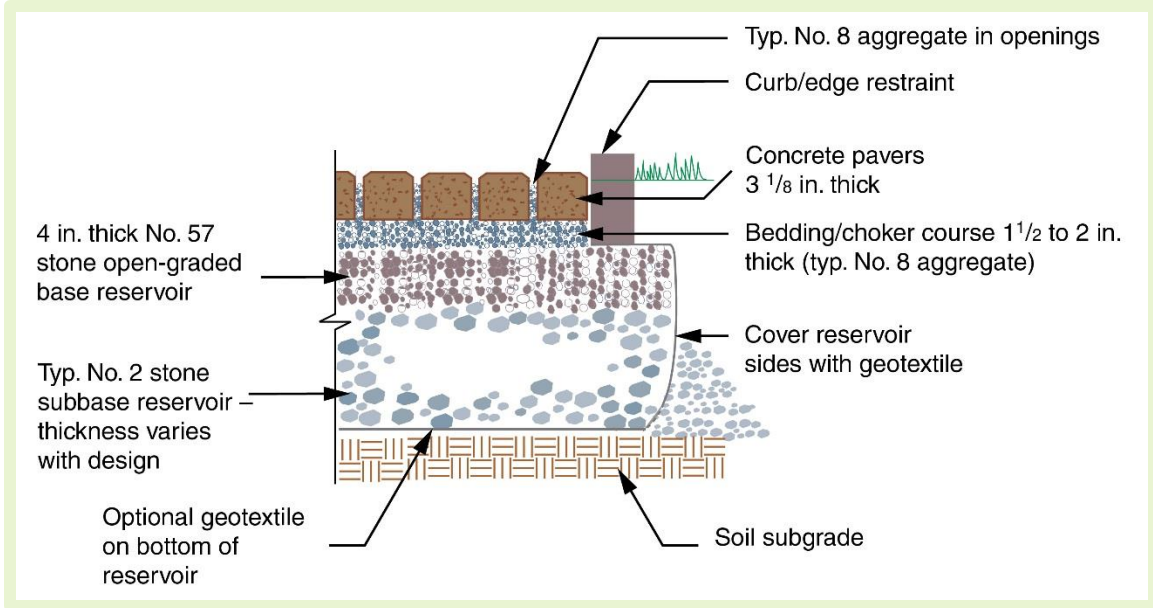


Figure 6-39. Typical Permeable Paver Section (Credit: ICPI)

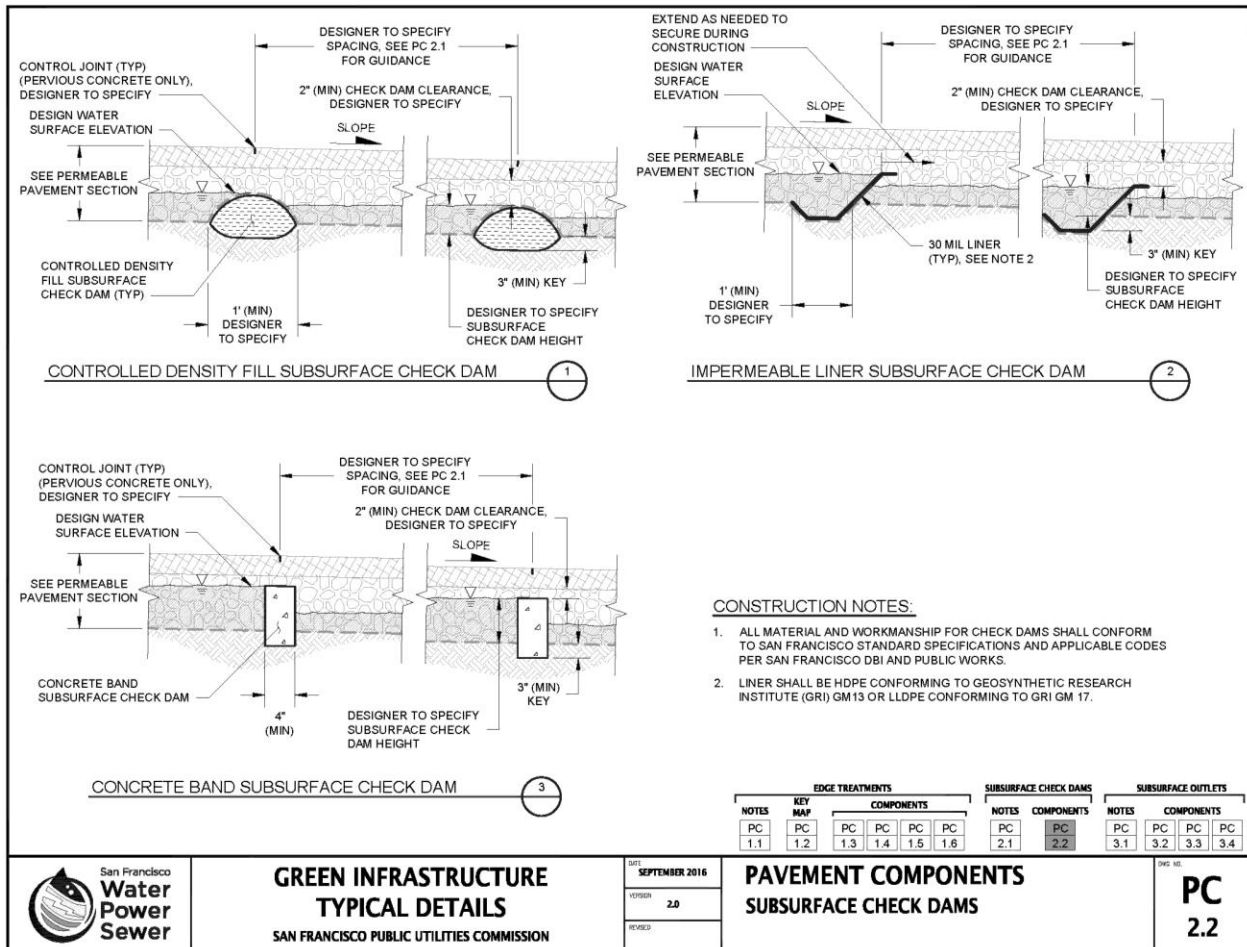


Figure 6-40. Subsurface Check Dam Details – PC 2.2 from the GI Design Guide (Credit: SMCWPPP Sustainable Streets Typical GI Details and SFPUC)

## 6.7 Reinforced Grid Paving

### Overview

#### Description

Reinforced grid paving consists of concrete or plastic grids used in areas that receive occasional light traffic (i.e., < 7,500 lifetime 18,000-lb equivalent single axle loads or a Caltrans Traffic Index < 5), typically overflow parking or fire access lanes, when placed over compacted Caltrans Class 2 or Class 2 permeable base or similar materials. Class 2 permeable base should use an underdrain in silt and clay soils. The surfaces of these systems can include a layer of gravel as shown in Figure 6-41 below or be planted with topsoil and grass in their openings or installed over a bedding layer that rests over a compacted, dense-graded aggregate base (see Figure 6-42 and Figure 6-43). When planted with turf grass, they also assist in providing a cooler surface than conventional pavement. Some of these systems are also known as turf block or grasscrete. Reinforced grid paving can also be designed with aggregate in the openings.



Figure 6-41. Reinforced grid paving in an overflow parking lot in Napa. (Credit: EOA, Inc.)

Reinforced grid paving can be installed over open-graded aggregate bases for additional water storage, infiltration, and outflow via an underdrain in low permeability soils if needed. However, such designs should see limited automobile traffic and no truck traffic other than rarely occurring emergency vehicles. Reinforced grid pavings are not considered an impervious area and can function as “self-treating areas” when supported by an aggregate base sufficient to hold the C.3.d amount runoff. Reinforced grid pavings with dense-graded bases are not generally designed to accept runoff from adjacent areas.

#### Best uses

- Overflow parking areas
- Emergency access lanes
- Common areas
- Lawn/landscape buffers
- Pathways

#### Advantages

- Flow attenuation
- Removes fine particulates
- Reduces need for treatment

#### Limitations

- May clog without periodic cleaning
- May allow weed growth
- Lightly trafficked areas only
- Higher installation costs than conventional paving

The Countywide Program gratefully acknowledges the contributions of Mr. David Smith, formerly Technical Director of the Interlocking Concrete Pavement Institute, to this section of the Guide, including pavement sections, design details, and specifications.

**Siting**

Contrary to most other treatment measures, small areas of reinforced grid paving do not need as much maintenance so they can be located in remote sections of private property such as backyards and pathways. However, if the areas total 3,000 sq. ft. or more, they are considered regulated treatment systems and they require an O&M agreement, with municipal inspections at least once every five years. Therefore, they should only be constructed in front yards, driveways, parking lots and other areas visible from the public right of way so that municipal inspectors can see and verify the existence of the systems.

*Table 6-10: Recommended locations for reinforced grid paving*

Recommended Locations	Reinforced Grid Paving
Parking Lot	●
Roof	
Driveway	●
Podium-level	
Close to building	
Away from Buildings	●
Underground	



### *Design and Sizing Guidelines*

To provide satisfactory performance, the following criteria should be considered:

#### Subgrade and Site Requirements

- The soil subgrade should be able to sustain anticipated traffic loads without excessive deformation while temporarily saturated.
- The soil subgrade should have sufficient permeability to meet the requirements in this manual, or include an underdrain(s) to remove detained flows within the aggregate base. The surfacing and bedding materials are not used to store water.
- Depth to seasonal high groundwater level should be at least 5 feet from the bottom of the base of the reinforced grid paving system, unless a different separation is recommended by the geotechnical engineer.
- Reinforced grid paving systems should not be used where site conditions do not allow infiltration.
- Grading of the soil subgrade below the reinforced grid paving should be relatively flat to promote infiltration across the entire area or berms should be used. Underground slopes of reinforced grid paving should not exceed 5%. Slopes exceeding 3% typically require berms or check dams placed laterally over the soil subgrade to slow the flow of water and increase infiltration.
- A slope of 1% is recommended for the pavement surface.

#### Aggregates

- When subject to vehicular traffic, all dense-graded aggregate bases should conform to Caltrans Class 2 or similar specifications as directed by the municipality. All open-graded aggregates should be crushed material, minimum 50% with one or more fractured faces conforming to Caltrans test method CT 205; have Los Angeles Rattler no greater than 45% loss at 500 revolutions per Caltrans test method CT 211; and a minimum Cleanness value of 75 per Caltrans test method CT 211. Sieve analysis should conform to Caltrans test method CT 202.
- If the subbase/base layer is sized to hold at least the C.3.d amount of runoff, the area of reinforced grid paving is not considered an impervious surface and can function as a self-treating area as described in Section 4.1.
- If an underdrain is used, position the perforated pipe within the subgrade enveloped on all sides by at least 4 inches of open-graded aggregate and provide non-perforated, upturned elbow pipe for outflows. A cleanout with surface access is recommended at the upturn. To be considered a self-treating area or self-retaining area, the underdrain raised outlet should be positioned above the portion of the base layer that stores and infiltrates the C.3.d amount of rainfall onto the reinforced grid paving (and runoff from adjacent areas, if self-retaining).
- Design calculations for the base should describe and quantify the following:
  - Soil type/classification and soil permeability rate; for vehicular areas, k-values (psi/cubic inch) or R-values characterizing soil strength when saturated
  - Fill type if used, installation, and compaction methods plus target densities

- Lifetime expected traffic loading in 18,000 lb. equiv. single axle loads or Caltrans Traffic Index
- Drainage routing of detained flows within the aggregate base as well as expected infiltration into in-situ soils, or collection in underdrain if the permeability cannot meet design criteria

### Reinforced Grid Paving Materials

- Concrete grids should conform to the dimensional tolerances, compressive strength, and absorption requirements in ASTM C1319 and should be a minimum of 3 1/8 in. thick.
- Aggregates used for bedding and filling the grid openings should be No. 8 stone or similar sized crushed materials.
- If topsoil and grass are used in the grids, they should be placed over a 1 in. thick layer of bedding sand and over Caltrans Class 2 base compacted to a minimum 95% standard Proctor density. Do not use topsoil, grass, sand bedding and geotextile over an open-graded aggregate base as the surface has a low permeability.
- Reinforced grid paving should have edge restraints to render them stationary when subject to pedestrian or vehicular traffic.

### *Construction and Maintenance Plans*

#### Design and Installation Recommendations

- All designs should be reviewed and approved by a licensed civil or geotechnical engineer or as directed by the municipality.
- Design for plastic reinforced grid paving should be done per the manufacturer's recommendation. Such designs should be reviewed by the manufacturer or as directed by the municipality.
- Installation of reinforced grid paving should be done by contractors who have constructed projects similar in size to that under consideration.
- Protect excavated area from excessive compaction due to construction traffic and protect the finished pavement from construction traffic.
- ***For additional construction guidelines, see Chapter 4 of the GI Design Guide.*** Specifically, see Sections 4.3 through 4.9 of the GI Design Guide for construction strategies for dealing with slopes, overflows, poor soils, utilities, runoff capture, etc.

#### Remember

#### Maintenance Considerations

- See Chapter 8 for specific maintenance guidance. Specifically, see Section 8.3.6 for maintenance concerns specific to reinforced grid paving.
- A Maintenance Agreement should be provided for Regulated Projects with installations of 3,000 square feet or more of reinforced grid paving.
- The Maintenance Agreement should state the parties' responsibility for maintenance and upkeep.
- Prepare a maintenance plan and submit with the Maintenance Agreement. Maintenance plan templates are in Appendix G.

*Typical Design Details*

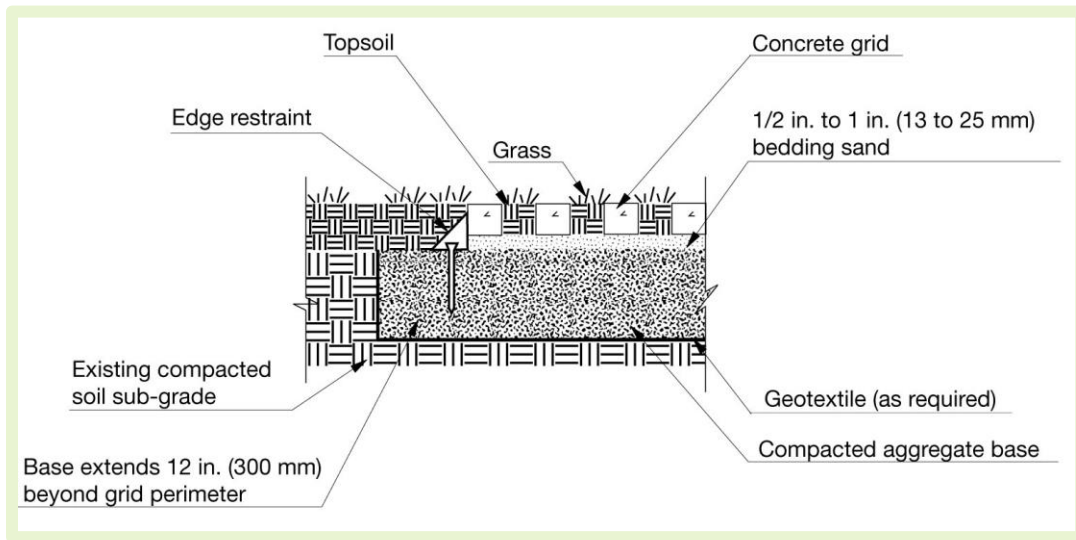


Figure 6-42: Concrete Reinforced Grid Paving for Occasional Vehicular Use or for Emergency Access Lanes. (Credit: Santa Clara Valley Urban Runoff Pollution Prevention Program)



Figure 6-43: Plastic Reinforced Grid Paving for Occasional Vehicular Use or for Emergency Access Lanes (Credit: Santa Clara Valley Urban Runoff Pollution Prevention Program). Note: Sand and turf grass can be replaced with ASTM No. 8 aggregate in cell openings.

## 6.8 Green Roof

### Overview

#### Description



Figure 6-44: Parking Lot with Turf-Covered Intensive Green Roof, Google building, Mountain View; and Modular Extensive Green Roof installation, Emeryville. (Credit: EOA Inc.)

A green roof can be either **extensive**, with 3 to 7 inches<sup>42</sup> of lightweight substrate and a few types of low-profile, low-maintenance plants, or **intensive** with a thicker (8 to 48 inches) substrate, more varied plantings, and a more garden-like appearance. The extensive installation at the Gap Headquarters in San Bruno (Figure 6-45) was installed in 1997. Green roofs provide energy savings, and native vegetation may be selected to provide habitat for endangered species of butterflies, as at the extensive green roof of the Academy of Sciences in San Francisco.

#### Best uses

- For innovative architecture
- Where limited space at grade is available

#### Advantages

- Minimizes roof runoff
- Reduces “heat island” effect
- Absorbs sound and saves energy
- Provides bird/insect habitat
- Longer “lifespan” than conventional roofs

#### Limitations

- Sloped roofs may require steps
- Non-traditional design
- Can increase structural costs

<sup>42</sup> [www.waterboards.ca.gov/sanfranciscobay/water\\_issues/programs/stormwater/muni/mrp/05-02-2011/Green\\_Roof.pdf](http://www.waterboards.ca.gov/sanfranciscobay/water_issues/programs/stormwater/muni/mrp/05-02-2011/Green_Roof.pdf)

## Siting

- For strategies and examples of how to retrofit sites and parcels to include green roofs, *see Sections 3.2 and 3.3 of the GI Design Guide.*
- See [www.greenroofs.com](http://www.greenroofs.com) for information about and more examples of green roofs.
- Remember that stormwater control measures should be located in areas that can be accessible at any given time for the purpose of operation and maintenance and inspections.
- Green roofs can be sited on podium levels, roof tops, garbage enclosures, parking garages, plazas over underground buildings etc. Example projects are shown in the pictures below.

*Table 6-11: Recommended locations for green roofs*

Recommended Locations	Green Roof
Parking Lot	
Roof	●
Driveway	
Podium-level	●
Close to building	
Away from Buildings	
Underground	



*Figure 6-45: Top: Extensive Green Roof at YouTube Headquarters, San Bruno (Courtesy of William McDonough & Partners); Bottom: Intensive Green Roof, Kaiser Center Parking Garage, Oakland. (Credit: Gene Anderson)*

## Design and Sizing Guidelines

### Treatment Dimensions and Sizing

- Green roofs are considered “self-treating areas” or “self-retaining areas” and may drain directly to the storm drain, if they meet the following requirements specified in the MRP:
- The green roof system planting media should be sufficiently deep to provide capacity within the pore space of the media to capture 80 percent of the average annual runoff.
- Extensive green roof systems contain layers of protective materials to convey water away from roof deck. Starting from the bottom up, a waterproof membrane is installed, followed by a root barrier, a layer of insulation (optional), a drainage layer, a filter fabric for fine soils, engineered growing medium or soil substrate, and plant material.
- The components of intensive green roofs are generally the same as those used in extensive green roofs, with differences in depth and project-specific design application.
- Follow manufacturer recommendations for slope, treatment width, and maintenance.
- Green roof should be free of gullies or rills.

### Vegetation

- The planting media should be sufficiently deep to support the long-term health of the vegetation selected for the green roof, as specified by the landscape architect or other knowledgeable professional.
- Either grass or a diverse selection of other low growing, drought tolerant, native vegetation should be specified. Vegetation whose growing season corresponds to the wet season is preferred. See Appendix A for planting guidance.
- Irrigation is typically required.



*Figure 6-46: Plants selected to support endangered butterflies on the extensive Green Roof at the California Academy of Sciences, San Francisco (Credit: Tim Griffith)*

## *Construction and Maintenance Plans*

### Design and Installation Recommendations

- Design and installation are typically completed by an established vendor.
- ***For additional construction guidelines, see Chapter 4 of the GI Design Guide.*** Even though the GI Design Guide does not include specific construction guidance for green roofs, general information on runoff capture and utility constraints can apply to green roofs.


### Maintenance Recommendations

- Although green roofs are often categorized as “site design measures”, a Maintenance Agreement may be required by the municipality. The Maintenance Agreement should state the parties’ responsibility for maintenance and upkeep.
- Inspections should be conducted by the project owner at least semiannually. Confirm adequate irrigation for plant health.
- Care for plants and replenish growing media as specified by landscape designer and as needed for plant health. See Appendix A for IPM methods.




### Typical Design Details





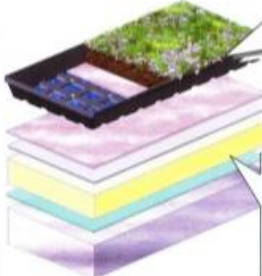
**GREENGRID**  
The Natural Choice for Your Roof



**TRELLEBORG**

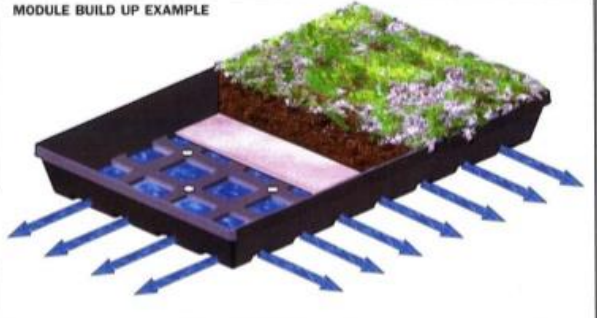
**THE MODULAR GREEN ROOF SYSTEM**

- Water reservoirs retain 99% of a 25mm rainfall
- Drainage holes allow water run-off to roof surface
- Non woven geotextile filtration layer
- Plants flourish in depth of growing media
- Wide variety of plant choice
- Recycled material content



**ROOF BUILD UP EXAMPLE**

- Protection Fleece
- Waterproofing Membrane
- Insulation
- Vapour Control Layer
- Concrete deck



**MODULE BUILD UP EXAMPLE**

**Module Dimensions**

600mm (W) x 600mm (L) x 100mm (D)	Extensive
600mm (W) x 1200mm (L) x 100mm (D)	Extensive
600mm (W) x 1200mm (L) x 200mm (D)	Intensive

**Saturated Weight**

75kg/m <sup>2</sup> - 100mm depth module
134kg/m <sup>2</sup> - 200mm depth module

Trelleborg - Suite 3D, Willow House, Stratfields Business Park, Beckett, Leamington CV4 3PB Tel: +44 (0)1898 464620 Fax: +44 (0)1898 464623 Email: thecustomers@trelleborg.com  
www.greengridroofs.co.uk

Figure 6-47: Green roof cross-sections (Credit: American Wick Drain Corp and GreenGrid)

## 6.9 Rainwater Harvesting and Use

### Overview

#### Description

Rainwater harvesting systems are engineered to store a specified volume of water with no discharge until this volume is exceeded. Storage facilities that can be used to harvest rainwater include above-ground or below-ground cisterns, open storage reservoirs (e.g., ponds and lakes), and various underground storage devices (tanks, vaults, pipes, arch spans, and proprietary storage systems).



Figure 6-48: Rainwater is collected and used for flushing toilets at Mills College, Oakland. (Credit: EOA)

#### Best uses

- High density residential or office towers with high toilet flushing demand
- Park or low density development with high irrigation demand.
- Industrial use with high non-potable water demand

#### Advantages

- Helps obtain LEED or other credits for green building

#### Limitations

- High installation and maintenance costs
- High toilet flushing or irrigation demand needed to use design volume

Rooftop runoff is the stormwater most often collected in harvesting/use system, because it often contains lower pollutant loads than surface runoff, and it provides accessible locations for collection. Rainwater can also be stored under hardscape elements, such as paths and walkways, by using structural plastic storage units, such as RainTank, or other proprietary storage products. Water stored in this way can be used to supplement onsite irrigation needs, typically requiring pumps to connect to the irrigation system. Rain barrels are often used in residential installations, but typically collect only 55 to 120 gallons per barrel; whereas systems that are sized to meet Provision C.3 stormwater treatment requirements typically require thousands of gallons of storage.

Uses of captured water may potentially include irrigation, indoor non-potable use such as toilet flushing, industrial processing, or other uses. In the Bay Area, toilet flushing is the use that is most likely to generate sufficient demand to use the C.3.d amount of runoff. The demand for indoor toilet flushing is most likely to equal to the C.3.d amount of stormwater in high rise residential or office projects, and in schools. Irrigation demand may equal the C.3.d amount of runoff in projects with a very high percentage of landscaping.

## Siting

For strategies and examples of how to retrofit sites and parcels to include rainwater harvesting systems, *see Sections 3.2 and 3.3 of the GI Design Guide.*

Remember that stormwater control measures should be located in areas that can be accessible at any given time for the purpose of operation and maintenance and inspections. Rainwater harvesting units used to meet C.3.d treatment requirements should not be located on inaccessible private property such as residential backyards.

*Table 6-12: Recommended locations for rainwater harvesting systems areas*

Recommended Locations	Rainwater Harvesting
Parking Lot	
Roof	●
Driveway	
Podium-level	●
Close to building	●
Away from Buildings	●
Underground	●

## Design and Sizing Guidelines

### System Components

Rainwater harvesting systems typically include several components: (1) methods to divert stormwater runoff to the storage device, (2) an overflow for when the storage device is full, (3) a distribution system to get the water to where it is intended to be used, and (4) filtration and treatment systems (see Treatment Requirements below).

#### *Leaf Screens, First-Flush Diverters, and Roof Washers*

These features may be installed to remove debris and dust from the captured rainwater before it goes to the tank. The initial rainfall of any storm often picks up the most pollutants from dust, bird droppings and other particles that accumulate on the roof surface between rain events. Leaf screens remove larger debris, such as leaves, twigs, and blooms that fall on the roof. A first-flush diverter routes the first flow of water from the catchment surface away from the storage tank to remove accumulated smaller contaminants, such as dust, pollen, and bird and rodent droppings. A roof washer may be placed just ahead of the storage tank and filters small debris for systems using drip irrigation. Roof washers consist of a tank, usually between 30- and 50-gallon capacity, with leaf strainers and a filter.

#### *Codes and Standards*

The State of California added rainwater harvesting and graywater regulations into the State's Plumbing Code on January 1, 2014. The code was updated in 2016 and 2019. Chapter 16 of the code, "Nonpotable Rainwater Catchment Systems", allows rainwater to be harvested from roof tops for use in outdoor irrigation and some non-potable indoor uses. Rainwater collected from parking lots or other impervious surfaces at or below grade is considered graywater and subject to the water quality requirements for graywater in Chapter 15 of the code. Some small catchment systems (5,000 gallons or less) being used for non-spray irrigation do not require permits – see Chapter 16 for more details<sup>43</sup>.

The Plumbing Code defines rainwater as "precipitation on any public or private parcel that has not entered an offsite storm drain system or channel, a flood control channel, or any other stream channel, and has not previously been put to beneficial use."<sup>44</sup> The Rainwater Capture Act of 2012, which took effect January 1, 2012, specifically states that the use of rainwater collected from rooftops does not require a water right permit from the State Water Resources Control Board.

The ARCSA/ASPE Rainwater Catchment Design and Installation Standard<sup>45</sup> may also be used as a resource.

#### *Treatment Requirements*

Rainwater catchment system treatment requirements in the code vary depending on the use. Small systems described above are not required to treat rainwater. Other systems may be required to remove

---

<sup>43</sup> 2019 California Plumbing Code, <https://iapmo.org/publications/read-uniform-codes-online/>  
Select CPC 2019 and click on Chapter 16

<sup>44</sup> <https://up.codes/viewer/california/ca-plumbing-code-2016/chapter/15/alternate-water-sources-for-nonpotable-applications#15>

<sup>45</sup> American Rainwater Catchment Systems Association (ARCSA) and American Society of Plumbing Engineers (ASPE), August 2009. Rainwater Catchment Design and Installation. See: [www.harvesth2o.com/adobe\\_files/ARCSA\\_Rainwater%20Code.pdf](http://www.harvesth2o.com/adobe_files/ARCSA_Rainwater%20Code.pdf).

turbidity, bacteria, particulates and/or debris. Uses of rainwater for car washing, drip irrigation and small volume spray irrigation require filtration, while uses for large volume spray irrigation, toilet flushing, ornamental water features and cooling tower makeup water require filtration and disinfection. More details are provided in Plumbing Code Chapter 16, Table 1602.9.6.

The 2019 California Plumbing Code contains minimum treatment and water quality standards for rainwater, which are summarized in Table 6-13 below.

*Table 6-13  
Summary of Minimum Treatment and Water Quality Standards for Rainwater*

<b>Application</b>	<b>Minimum Treatment</b>	<b>Minimum Water Quality</b>
Non-spray irrigation (less than 5,000 gallons of storage)	No treatment required if tank is supported directly on grade and height: width ratio < 2:1	N/A
Spray irrigation (less than 360 gallons of storage);	Debris excluder or other approved means	N/A
Surface, subsurface, and drip irrigation; car washing	Debris excluder or other approved means; 100 micron filter for drip irrigation	N/A
Spray irrigation (360 gallons or more of storage); ornamental fountains and other water features	Debris excluder or other approved means	Turbidity < 10 NTU; Escherichia coli < 100 CFU/100 ml
Toilet flushing, clothes washing, and trap priming; cooling tower make-up water	Debris excluder or other approved means; 100 micron filter for drip irrigation	Turbidity < 10 NTU; Escherichia coli < 100 CFU/100 ml
Source: 2019 California Plumbing Code, Table 1602.9.6, Chapter 16 page 329.		

## Hydraulic Sizing

- If a rainwater harvesting system will be designed to meet Provision C.3 stormwater requirements, there must be sufficient demand to use 80 percent of the average annual rainfall runoff, as specified in Provision C.3.d. Appendix I provides guidance on how to estimate the required landscaping or toilet flushing demand to meet C.3.d. requirements.
- If the project appears to have sufficient demand for rainwater, size the cistern (or other storage device) to achieve the appropriate combination of drawdown time and cistern volume indicated in the sizing curves in Appendix I.
- If a rainwater harvesting system is designed for less than the water quality design volume, the overflow must receive additional treatment, e.g., by infiltration in landscaping or by infiltration/biotreatment in a bioretention area.

## Design Guidelines for All Systems

- Equip water storage facilities covers with tight seals, to reduce mosquito-breeding risk. Follow mosquito control guidance in Appendix F.
- Water storage systems in proximity to the building may be subject to approval by the building official. The use of waterproofing as defined in the building code may be required for some systems, and the municipality may require periodic inspection. Check with municipal staff for the local jurisdiction's requirements.
- Do not install rainwater storage devices in locations where geotechnical/stability concerns may prohibit the storage of large quantities of water. Above-ground cisterns should be located in a stable, flat area, and anchored for earthquake safety.
- To avoid excess hydraulic pressure on subsurface cisterns:
  - The depth to seasonal high groundwater level should be at least 5 feet from the bottom of the cistern.
  - A geotechnical engineer should be consulted for situations where the bottom of the cistern is less than 5 feet from the seasonal high groundwater level.
- Provide separate piping without direct connection to potable water piping. Dedicated piping should be color coded and labeled as harvested rainwater, not for consumption. Faucets supplied with non-potable rainwater should include signage identifying the water source as non-potable and not for consumption.
- The harvesting system must not be directly connected to the potable water system at any time.
- When make-up water is provided to the harvest/reuse system from the municipal system, prevent cross contamination by providing a backflow prevention assembly on the potable water supply line, an air gap, or both, to prevent harvested water from entering the potable supply. Contact local water system authorities to determine specific requirements.
- The rainwater storage facility should be constructed using opaque, UV resistant materials, such as heavily tinted plastic, lined metal, concrete, or wood, or protected from sunlight by a structure or roof to prevent algae growth. Check with municipal staff for local building code requirements.
- Storage facilities should be provided with access for maintenance, and with a means of draining and cleaning.

### Design Guidelines for Indoor Use

- Avoid harvesting water for indoor use from roofs with architectural copper, which may discolor porcelain plumbing fixtures.
- Provide filtration of rainwater harvested for indoor non-potable use, as required by the California Plumbing Code (Table 6-13) and any municipality-specific requirements.

### Design Guidelines for Irrigation Use

- Water diverted by a first flush diverter may be routed to a landscaped area large enough to accommodate the volume, or a hydraulically-sized treatment measure.
- First flush diverters should be installed in such a way that they will be easily accessible for regular maintenance.
- When rainwater is harvested from roofs with wood shingles or shakes, asphalt shingles, tar, lead, etc., do not use to irrigate food-producing gardens as such materials may adversely affect food for human consumption.

### *Construction and Maintenance Plans*

- Hire a contractor experienced with the installation of rainwater harvesting systems, and follow California Plumbing Code requirements.
- Do not allow sediment to get into the system during construction, and protect from construction traffic.

Although the GI Design Guide does not include specific construction and maintenance guidance for rainwater harvesting, it does include design and siting guidance for these systems.

#### Remember

#### Maintenance Considerations for All Treatment Measures

- See Chapter 8 for specific maintenance guidance. See Section 8.3.7 for common maintenance concerns specific to rainwater harvesting.
- A Maintenance Agreement should be provided and should state the parties' responsibility for maintenance and upkeep.
- Prepare a maintenance plan and submit with Maintenance Agreement. See Appendix G of this Guide for maintenance plan templates.



## 6.10 Media Filter<sup>46</sup>

### Overview

#### Description

Media filters are flow-through treatment systems that remove pollutants from runoff through screening and adsorptive media such as sand, peat, or manufactured media. Types of non-vegetated<sup>47</sup> media filters include: 1) bed filters, such as Austin or Delaware sand filters; 2) proprietary modular cartridge filters; 3) powered filtration systems; and 4) catch basin inserts, also known as inlet filters.

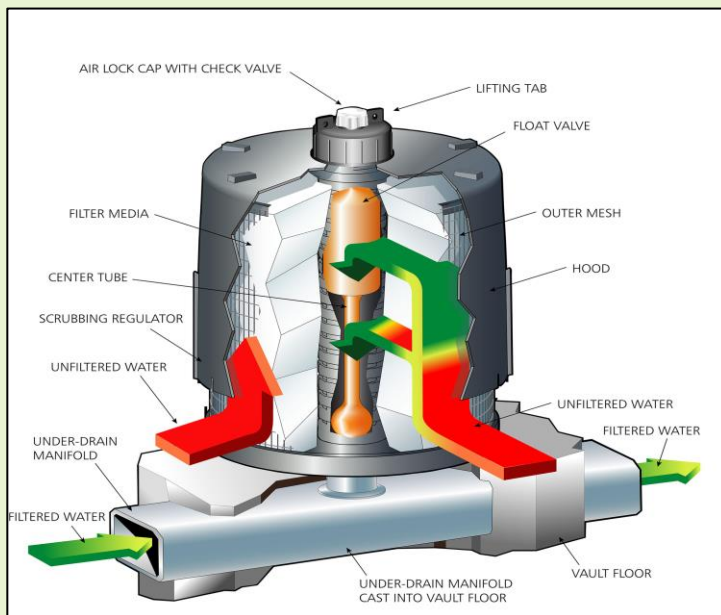


Figure 6-49. System C Filter Cartridge, Typically Used as Part of Treatment Train (Credit: CONTECH Engineered Solutions)

Under current Municipal Regional Permit (MRP) requirements, the use of media filters as a stand-alone treatment measure is no longer allowed, except at “Special Projects” that qualify for LID treatment reduction credits (see Appendix K). Media filters may also be used as part of a treatment train, for example, as pre-treatment for a subsurface infiltration system. Because Special Projects are typically dense urban infill projects where LID treatment is infeasible due to space constraints, this section focuses on proprietary cartridge filters, which are suitable for limited space and/or underground applications.

Cartridge filters use cartridges of a standard size that can be filled with various types of manufactured media, individually or in combination, including perlite (expanded volcanic ash), zeolite (natural mineral), granular activated carbon, and granular organic media (such as processed leaves). The media are designed to remove certain types of pollutants. The media cartridges are placed in vaults, manholes, or catch basins. In the unit shown in Figure 6-49, the water flows laterally (horizontally and upwards) into the cartridge,

#### Best uses

- Limited space
- Underground
- As part of a treatment train (pre-treatment)

#### Advantages

- Less area required
- Customized media
- Customized sizing

#### Limitations

- Not considered LID
- No removal of trash without pre-treatment
- High installation and maintenance costs
- Confined space entry may be required
- Media filtration is allowed only for qualifying “special projects”

<sup>46</sup> Note: The proprietary media filters shown are for general information only and are not endorsed by the Countywide Program. An equivalent media filter system may be used.

<sup>47</sup> Vegetated media filters using biotreatment soil media are described in the bioretention, flow-through planter, and tree well filter sections of the C.3 Technical Guidance.

through the media to a center tube, then downward to an underdrain system. The number of cartridges required is a function of the water quality design flow rate and cartridge design operating rate (that is, the surface loading rate).

### Siting

Media filters should be located in areas that can be accessible at any given time for the purpose of operation and maintenance and inspections. Media filter access manholes should not be located in parking stalls because they can't be inspected if a car is parked in the spot. Media filters should also not be located in garages or other areas with limited overhead clearance as large vector trucks need access for cleaning.

*Table 6-14: Recommended locations for media filters*

Recommended Locations	Media Filter
Parking Lot	•
Roof	
Driveway	•
Podium-level	
Close to building	•
Away from Buildings	•
Underground	•

### *Design and Sizing Guidelines*

- The selected media filter product must be certified by the Washington State Technical Assistance Protocol – Ecology (TAPE) program under the General Use Level Designation (GULD) for Basic Treatment<sup>48</sup>. A list of proprietary media filters currently holding this certification can be obtained from the Department of Ecology’s website<sup>49</sup>.
- The treatment measure should be sized based on the water quality design flow specified in MRP Provision C.3.d and the cartridge design operating rate for which the product received TAPE GULD certification.
- Consult the manufacturer to determine the proper type of media for the project site and pollutants of concern. Some use combinations of media to address a wide range of pollutants.
- Pretreatment to remove debris and coarse sediment upstream of the media filter is highly recommended. Pretreatment can be provided in a separate upstream unit and/or within the vault containing the cartridges (see Figures 6-48 and 6-49).
- Consider filter head loss when selecting a media filter product. Options may be limited if the site has limited available head or if trying to match up with existing storm drain invert elevations.
- Include provisions for bypassing high flows, either an internal bypass within the treatment measure or an external bypass using a piping configuration with a flow splitter (see Figure 6-51 for an example).
- Inform the contractor that, if there is a product substitution prior to or during construction, he/she must obtain approval from the local jurisdiction for any changes in the selected treatment product or design. The substituted produce must have TAPE GULD certification, and the design calculations must be revised if the design operating rate of the substituted product is different than the originally specified product.

---

<sup>48</sup> “General Use” is distinguished from pilot or conditional use designation, and “Basic Treatment” is distinguished from treatment effectiveness for phosphorus removal. Basic treatment is intended to achieve 80% removal of total suspended solids (TSS) for influent concentrations from 100 mg/l to 200 mg/l and achieve 20 mg/l TSS for less heavily loaded influents.

<sup>49</sup> See: <https://ecology.wa.gov/Regulations-Permits/Guidance-technical-assistance/Stormwater-permittee-guidance-resources/Emerging-stormwater-treatment-technologies#tape>

### *Construction and Maintenance Plans*

- Consult the manufacturer for construction and maintenance requirements.
- Additional guidance is included in Chapter 8 and Appendix G of this Guide.

### Installation Requirements

- Consult the manufacturer to determine the installation requirements for a specific product.
- For vault-based media filters, base preparation will be required. Typically, the soil subbase will need to be compacted and a minimum 6-inch layer of crushed rock base material provided. See manufacturer's specifications.
- To avoid excess hydraulic pressure on subsurface treatment system structures:
  - The depth to seasonal high groundwater level should be at least 5 feet from the bottom of the structure.
  - A geotechnical engineer should be consulted for situations where the bottom of the structure is less than 5 feet from the seasonal high groundwater level.

### Remember

#### Maintenance Considerations for All Treatment Measures

- See Chapter 8 for specific maintenance guidance. Specifically, see Section 8.3.8 for common maintenance concerns.
- A Maintenance Agreement should be provided and should state the parties' responsibility for maintenance and upkeep.
- Prepare a maintenance plan and submit with Maintenance Agreement. Maintenance plan templates are in Appendix G.

Typical Design Details

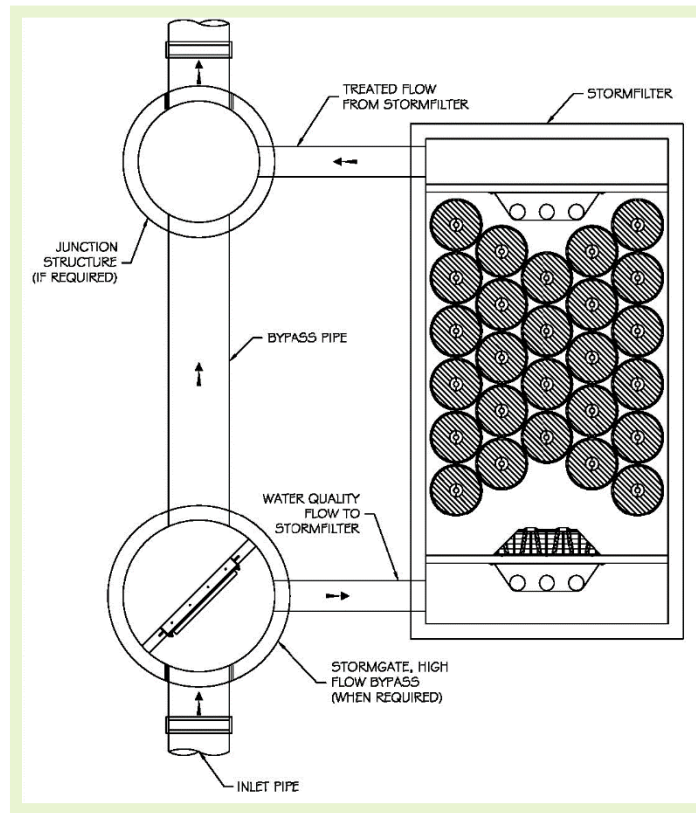


Figure 6-50. Profile View, Typical Cartridge System Filter Array (Credit: CONTECH Engineered Solutions). Note: The proprietary media filters shown are for general information only and are not endorsed by the Countywide Program.

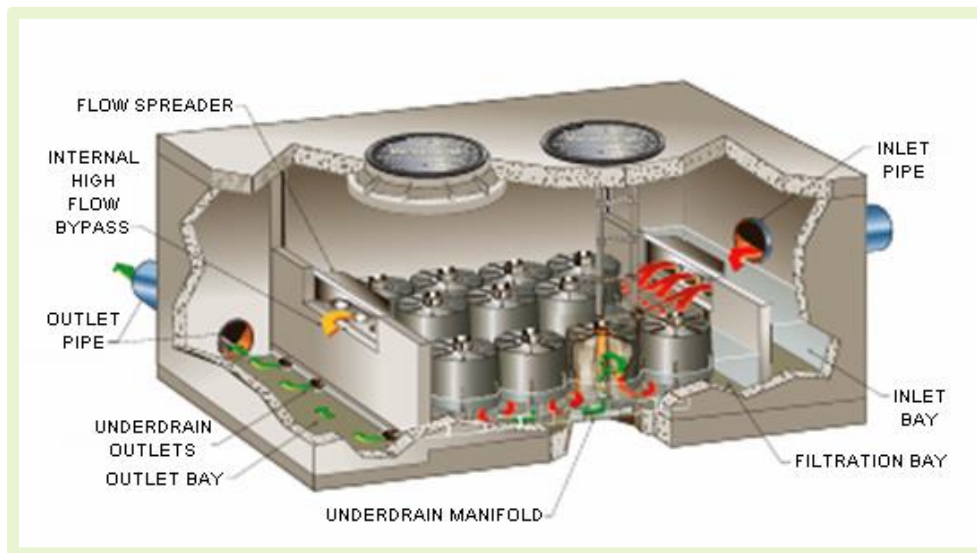


Figure 6-51. Plan View, Typical Cartridge System Filter Array (Credit: CONTECH Engineered Solutions). Note: The proprietary media filters shown are for general information only and are not endorsed by the Countywide Program.

## 6.11 Subsurface Infiltration System

### Overview



Figure 6-52: Photo of subsurface retention/infiltration system installation under a parking lot (Credit: CONTECH Engineered Solutions)

### Description

Subsurface infiltration systems, also known as infiltration galleries, are underground vaults or pipes that store and infiltrate stormwater. Storage can take the form of large-diameter perforated metal or plastic pipe, or concrete arches, concrete vaults, plastic chambers or crates.

These systems allow infiltration into surrounding soil while preserving the land surface above for parking lots, parks or playing fields. A number of vendors offer prefabricated, modular infiltration galleries in a variety of material types, shapes and sizes. Many of these options can be made strong enough for heavy vehicle loads, if needed.

Another type of subsurface infiltration system is an exfiltration basin or trench, which consists of a perforated or slotted pipe laid in a bed of gravel. It is similar to an infiltration basin or trench with the exception that it can be placed below paved surfaces such as parking lots and streets. Stormwater runoff is temporarily stored in perforated pipe or coarse aggregate and allowed to infiltrate into the trench walls bottom for disposal and treatment.

Subsurface infiltration systems are appropriate for residential and commercial sites where soil conditions and groundwater depths allow for safe infiltration of stormwater into the ground and no risk of groundwater contamination exists. These systems are not appropriate for industrial sites, locations where chemical spills may occur, fill sites or steep slopes. Pretreatment of runoff to remove sediment and other pollutants is typically required to maintain the infiltration capacity of the facility, reduce the cost and frequency of maintenance, and protect groundwater quality. A “subsurface fluid distribution system” is considered a Class V injection well that is regulated by EPA’s Underground Injection Control Program<sup>50</sup>

### Best uses

- Residential or commercial projects with large parking lots or common areas
- Large drainage areas

### Advantages

- Can be located beneath at grade features
- Systems are modular, allowing flexible design
- Multi-benefit attributes: groundwater recharge, flood mitigation, pollutant load reduction

### Limitations

- Not recommended for poorly infiltrating soils or highly polluted runoff with potential for groundwater contamination
- Requires pretreatment
- Can be high cost
- Potential for standing water and mosquito production

<sup>50</sup> See EPA Region 9’s website: <https://www.epa.gov/uic/underground-injection-control-regulations-and-safe-drinking-water-act-provisions>

These systems are “authorized by rule” and do not require a permit if they do not endanger underground sources of drinking water and comply with federal UIC requirements (see Appendix E of this Guide).

**Siting**

For strategies and examples of how to retrofit sites and parcels to include subsurface infiltration systems, *see Sections 3.2 and 3.3 of the GI Design Guide.*

Remember that stormwater control measures should be located in areas that can be accessible at any given time for the purpose of operation and maintenance and inspections.

A permit may be required from San Mateo County Environmental Health if the system is more than 10 feet deep or if groundwater is encountered during excavation.<sup>51</sup>

*Table 6-15: Recommended locations for subsurface infiltration systems*

Recommended Locations	Subsurface Infiltration System
Parking Lot	●
Roof	
Driveway	●
Podium-level	
Close to building	
Away from Buildings	●
Underground	●

<sup>51</sup> <https://www.smchealth.org/gpp>

### *Design and Sizing Guidelines*

#### Drainage Area and Setback Requirements

- In-situ/undisturbed soils should have a low silt and clay content and have permeability greater than 0.5 inches per hour. Hydrologic soil groups C and D are generally not suitable. Soil testing should be performed to confirm the permeability, and an appropriate safety factor (minimum of 2) applied as directed by the municipality.
- A 10-foot separation between the bottom of the Class 2 Perm and seasonal high groundwater levels is required to avoid the risk of groundwater contamination.
- A setback of 18 feet from building foundations is recommended, or a 1:1 slope from the bottom of the foundation, unless a different setback is allowed by a geotechnical engineer or local standard, or a cutoff wall is provided.
- Refer to Infiltration Guidelines (Appendix E) for additional setback and separation requirements.

#### Treatment Measure Dimensions and Sizing (Infiltration Galleries)

- The subsurface infiltration system should be sized to store and infiltrate the water quality design volume per MRP Provision C.3.d. The system may also be sized to store a larger volume for hydromodification management, if site conditions allow.
- Design the system to drain down (infiltrate) within 48-72 hours.
- The maximum allowable effective depth of water (inches) stored in the system can be calculated by multiplying the drawdown time (hours) by the design permeability of the native soils adjusted by the safety factor (in./hr.) The required footprint of the system can then be calculated by dividing the storage volume by the effective depth. Consult with the manufacturer for sizing of various components to achieve storage and infiltration of the water quality design volume.
- One or more observation wells should be installed to monitor water levels (drain time) in the facility. The well should be a minimum 6-inch diameter perforated PVC pipe, which is anchored vertically to a foot plate at the bottom of the facility.
- Maintenance access to the underground galleries must be provided, as periodic cleaning may be necessary to maintain performance. Open systems such as large diameter pipe or concrete structures can more easily be inspected and entered for maintenance if necessary than low profile or crate-type systems. The access should be large enough to allow equipment to be lowered into each gallery.
- Provide a layer of aggregate between the subsurface storage component or galleries and native soils to prevent migration of native soils into the storage component.

#### Treatment measure Dimensions and Sizing (exfiltration trenches)

- The exfiltration trench should be sized to store and infiltrate the water quality design volume per MRP Provision C.3.d. It is designed similar to an infiltration trench.
- A site-specific trench depth can be calculated based on the soil permeability, aggregate void space, and the trench storage time. The stone aggregate used in the trench is typically 1.5 to 2.5 inches in



diameter, which provides a void space of approximately 35 percent. Trenches may be designed to provide temporary storage of storm water, but should drain within 72 hours.

- The trench depth should maintain the required separation from seasonal high groundwater, and the depth should be less than the widest surface dimension.
- The invert of the trench should be flat (no slope).
- Place permeable filter fabric around the walls and bottom of the trench and top of the aggregate layer. The filter fabric should overlap each side of the trench in order to cover the top of the aggregate. The filter fabric prevents sediment in the runoff and soil particles from the sides of the trench from clogging the aggregate.
- A layer of filter fabric or sand should be placed at the bottom of the trench to keep the rock matrix from settling into the subgrade over time.
- An observation well should be installed to monitor water levels (drain time) in the trench. The well should be a minimum 6-inch diameter perforated PVC pipe, which is anchored vertically to a foot plate at the bottom of the trench.

### Inlets to Treatment Measure

- Flow may enter the treatment measure in the following ways:
  - Through a pipe
  - Through a drop inlet or catch basin
  - Through roof leader or other conveyance from building roof

### Pre-Treatment Measures

- The pretreatment measure(s) should be selected based on the expected pollutants on site and the infiltration system's susceptibility to clogging. Sediment removal is important for maintaining the long-term infiltration capability of the system.
- Hydrodynamic separators or media filters are most commonly used for subsurface systems, and are allowed as part of a treatment train with the infiltration system. Landscaped-based treatment, such as swales or bioretention areas may also be used upstream of subsurface systems if appropriate and if space allows.
- If a media filter is selected, refer to the discussion of media filter design in Section 6.10.

### *Construction and Maintenance Plans*

#### Construction Considerations

- The drainage area must be fully developed and stabilized with vegetation before constructing an infiltration trench. High sediment loads from unstabilized areas will quickly clog the infiltration trench. During project construction, runoff from unstabilized areas should be diverted away from the trench into a sedimentation control BMP until vegetation is established.
- Avoid spreading fines of the soils on bottom and side slopes while excavating. Loosen soils at the bottom of the excavation prior to constructing the infiltration trench.
- Avoid compaction of existing soils in the area of the infiltration. Protect from construction traffic.

#### Remember

#### Maintenance Considerations

- Provide a Maintenance Agreement (or other document or mechanism) that states the parties' responsibility for maintenance and upkeep.
- Prepare a maintenance plan and submit with Maintenance Agreement.

# Chapter 7: Hydromodification Management Measures

7.1	<i>What is Hydromodification?</i> .....	7-2
7.2	<i>Hydromodification Management (HM) Controls</i> .....	7-4
7.3	<i>Which Projects Need to Implement HM Controls?</i> .....	7-6
7.4	<i>Hydromodification Management (HM) Requirements</i> .....	7-7
7.5	<i>How to Implement HM Requirements</i> .....	7-8
7.5.1	Flow Duration Control .....	7-8
7.5.2	Application of Flow Duration Control to Project Areas .....	7-8
7.5.3	Bay Area Hydrology Model (BAHM) .....	7-10
7.6	<i>HM Control Design Process</i> .....	7-11
7.7	<i>HM Control Submittals for Review</i> .....	7-13
7.8	<i>Area-Specific HM Provisions</i> .....	7-14

## 7.1 What is Hydromodification?

Changes in the timing and volume of runoff from a site are known as “hydrograph modification” or “hydromodification”. When a site is developed, much of the rainwater can no longer infiltrate into the soils, so it flows offsite at **faster rates and greater volumes**. As a result, erosive levels of flow occur more frequently and for longer periods of time in creeks and channels downstream of the project. Hydrograph modification is illustrated in Figure 7-1, which shows the stormwater peak discharges after rainstorms in an urban watershed (the red, or dark, line) and a less developed (the yellow, or light, line). The axes indicate the volume of water discharged, and the time over which it is discharged.

### Definition

**Hydromodification** refers to changes in timing and volume of runoff from a site.

*Examples of causes:* increase in imperviousness, etc.

*Examples of consequences:* erosion, etc.

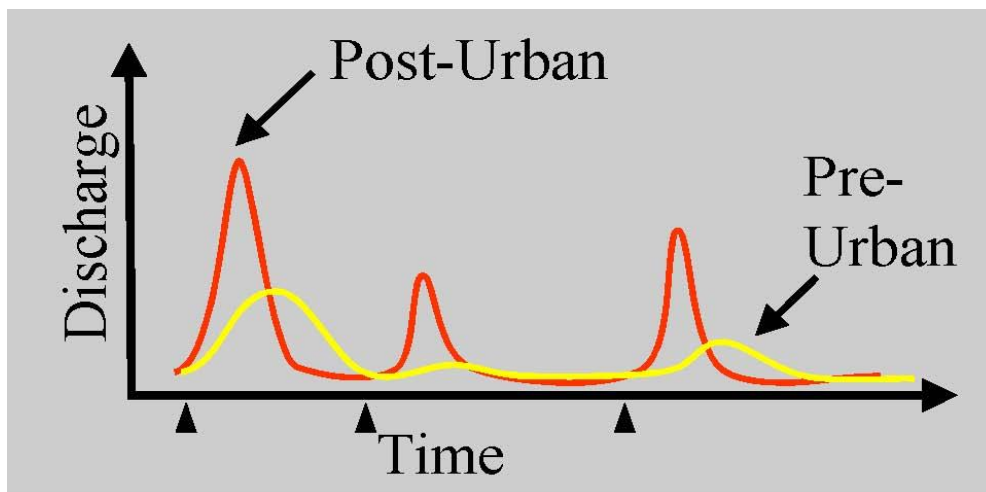


Figure 7-1: Stormwater Peak Discharges in Urban (Red) and Less Developed (Yellow) Watersheds (Credit: NEMO-California Partnership)

In watersheds with large amounts of impervious surface, the larger volumes, faster rates and extended durations of flows that cause erosion often cause natural creeks or earthen channels to erode and become incised, as the channel enlarges or deepens in response to the increased flows. **Problems from this additional erosion** often include private property and public infrastructure damage, degradation of stream habitat and water quality; these issues have not been addressed by traditional detention designs. Figures 7-2 and 7-3 illustrate the effect of increasing urbanization on stormwater volumes.

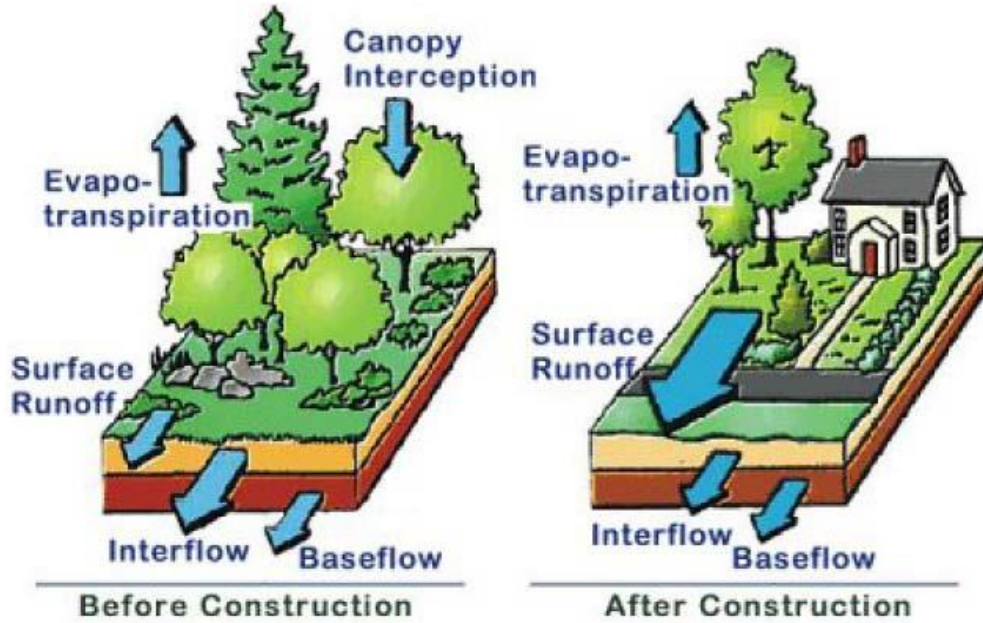


Figure 7-2: Effects of Urbanization on the Local Hydrologic Cycle  
 (Source: Maryland Stormwater Design Manual, 2000)

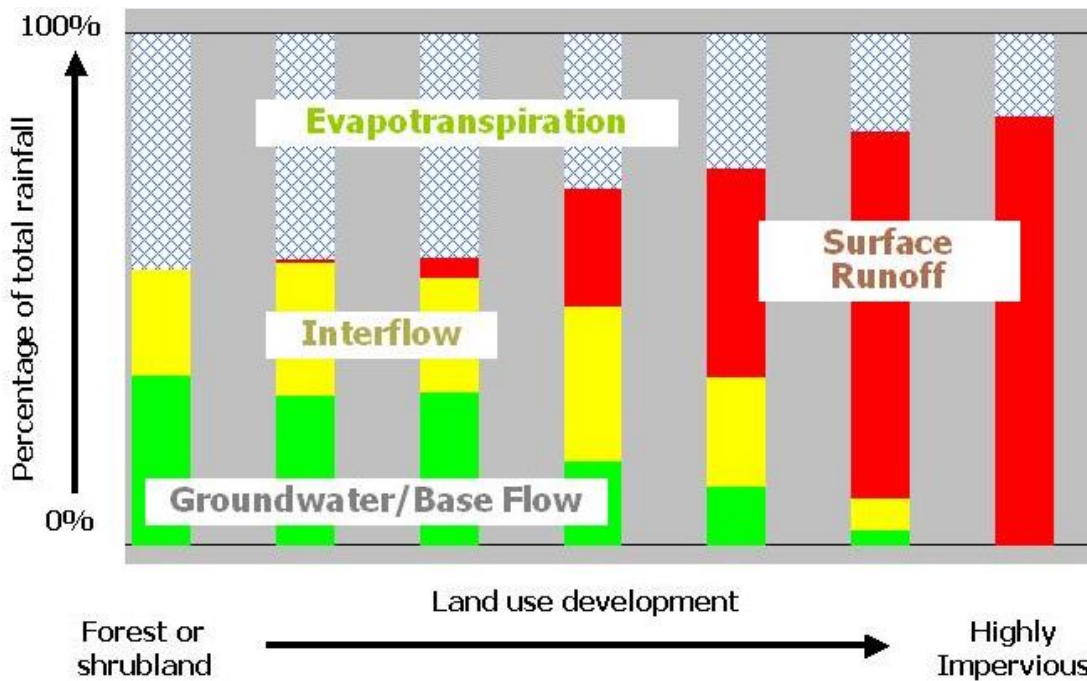


Figure 7-3. Variation in rainfall contribution to different components of the hydrological cycle for areas with different intensity of urban development (Courtesy of Clear Creek Solutions)

## 7.2 Hydromodification Management (HM) Controls

Since 2007, new hydromodification management (HM) techniques have been required in areas across the San Francisco Bay Area that are susceptible to hydromodification. These techniques focus on **retaining, detaining or infiltrating runoff** and matching post-project flows and durations to pre-project patterns for a specified range of smaller, more frequent rain events, to prevent increases in channel erosion downstream. Within San Mateo County, a simple map-based approach is used to determine which parts of the drainage network are susceptible to hydromodification impacts. Projects that meet certain criteria, and from which runoff passes through the susceptible areas, are required to incorporate one or more HM measures in the design in order to reduce erosive flows from a wide range of runoff conditions. HM measures can be grouped into three types:

### Key Point

Hydromodification management (HM) techniques focus on retaining, detaining or infiltrating runoff.

**Site design and hydrologic source control measures**, which are generally distributed throughout a project site. These types of measures minimize hydrological changes caused by development beginning with the point where rainfall initially meets the ground. Examples include minimizing impervious area, disconnecting roof leaders and providing localized detention. **LID treatment measures also serve as hydrologic source control measures** because they reduce runoff volumes and peak flows by retaining and detaining runoff.

**Flow duration control measures** are used to manage excess runoff from the site after hydrologic source control measures are applied. Stormwater is temporarily detained, and then the runoff is gradually discharged at a rate calculated to avoid adverse effects. Examples of storage facilities include extended detention basins, underground vaults, and oversized storm drainpipes. The discharge is controlled by outlet structures containing weirs and/or orifices designed to allow certain flow rates.

### Key Point

Flow duration control measures are sized to control the flow and duration of stormwater runoff according to a Flow Duration Control standard, which is **often greater** than size requirements for volume-based treatment.

Please note that there is a difference between the design approach for sizing measures to remove pollutants from stormwater and the approach for designing flow duration controls to prevent an increase in the potential for creek bank erosion. The treatment of stormwater pollutants targets capture of 80% of average runoff volume, which means that treatment measures will be bypassed every one to two years. Flow duration controls must be sized to control the statistical duration of a wide range of flow levels under simulated runoff conditions. Depending on pre-project and post project conditions, the required detention volume is **likely to be greater** than the capture volume required for treatment. Flow duration controls are typically used on-site, but larger facilities, such as detention basins, may be sized to control runoff from a regional drainage area. LID treatment measures can also be designed to achieve flow duration control and meet HM requirements.

**In-stream or restorative measures** are used to modify susceptible watercourses to withstand projected increases in runoff flows and durations without increasing erosion or other impacts to beneficial uses. In-stream measures are more complicated to use than other types of controls and are best suited for creeks or channels that have **already received impacts** from previous development and have only localized channel instability. Examples include biostabilization techniques using roots of live vegetation roots to stabilize banks and localized structural measures such as compost socks, rock weirs, boulder clusters or deflectors. An example of a compost sock installation that combines a localized structural measure and a biostabilization measure is shown in Figure 7-4 below. These measures will not automatically provide HM

## 7.2 Hydromodification Management (HM) Controls

protection for channel reaches farther downstream and may require longer planning timelines and cooperation among multiple jurisdictions compared to flow duration controls.



*Figure 7-4: In-stream restorative measure using compost socks and vegetation (Credit: Filtrexx)*

### 7.3 Which Projects Need to Implement HM Controls?

A project will be required to comply with the HM requirements if it meets all of the following applicability criteria:

- The project creates and/or replaces one acre or more of impervious surface,
- The project will increase impervious surface over pre-project conditions, AND
- The project is located in a susceptible area, as shown on the HM Control Area Map.

Appendix H contains the Countywide HM Control Area Map. The boundary between areas that are subject to HM requirements and areas that are not generally follows major roadways, such as El Camino Real and Alameda de Las Pulgas. Appendix H includes a series of maps that show more detail for locations in which the boundary does not follow major roadways. Areas exempt from HM requirements tend to be **heavily developed areas of the bayside**, while the more open and residential hillside, and coastal areas are generally subject to the HM requirements. Four municipalities -- East Palo Alto, Foster City, Daly City, and Colma -- are totally exempt (except for some small areas of parkland in which no development is expected to occur). All of the other municipalities have some portions of their jurisdictions where development may occur that would be subject to HM requirements.

Also note that projects located in susceptible areas are encouraged to include hydrologic source control measures for HM if they are likely to cause hydrograph changes, **even if they create and/or replace less than one acre of impervious surface**.



## 7.4 Hydromodification Management (HM) Requirements

The HM objective is to control stormwater discharges from non-exempt development projects so that these discharges do **not increase the erosion potential** of the receiving creek over the pre-project (existing) condition. This is accomplished by implementing four performance criteria:

Projects shall **provide hydromodification management (HM) controls** as needed to maintain the pre-project creek erosion potential. These controls may include a combination of on-site or off-site (regional drainage area and/or in-creek) control measures. An erosion potential (Ep) of up to 1.0 shall be maintained for creek segments downstream of the discharge point. Ep can be expressed as the ratio of post-project to pre-project erosive “work” done on the creek.

On-site stormwater controls that are designed to provide **flow duration control** to the pre-project condition shall comply with the HM requirements. Flow duration controls shall be designed so that the post-project stormwater discharge rates and durations match those of the pre-project condition, from 10 percent of the pre-project two-year peak flow up to the pre-project 10-year peak flow.

Projects may use **off-site control measures** in lieu of or in combination with on-site controls, where an approved plan – including an appropriate funding mechanism – is in place and accounts for the creek changes expected to result from changes in project runoff conditions. The off-site control measures or combination of controls shall be designed to achieve the management objective of keeping the erosion potential (Ep) at 1.0 or less, from the point of discharge to the creek as far down stream as potential impacts will occur.

### Key Point

Flow Duration Control looks at the full range of flows in a simulated long-term history, and is **not directly comparable** to approaches based on one or a few synthetic “design storms”.

## 7.5 How to Implement HM Requirements

Projects subject to HM requirements need to consider HM at every stage of project development, following the step-by-step instructions for C.3 submittals in Chapter 3. The most effective use of land and resources may require a combination of site design measures, treatment measures, flow duration control facilities and in-creek measures, which are described in Section 7.2. In general, the strategy for designing HM measures should:

**Start with site design** to minimize the amount of runoff to be managed (see Chapter 4).

**Incorporate treatment measures that provide detention storage** and help to reduce peak flows (e.g. bioretention facilities). Where possible, **maximize infiltration** to further reduce detention requirements. Note that infiltration is limited by site constraints such as slope stability concerns, low-permeability soils or groundwater protection constraints.

Use **flow duration controls** to detain the remaining calculated runoff from the site enough to **control its release** in a way that meets the remaining runoff design requirements. For some project locations, off-site options may be available to reduce or eliminate the need for onsite detention.

### 7.5.1 Flow Duration Control

Flow Duration Control (FDC) differs from traditional “design storm” approaches used to design detention facilities for flood control or water quality treatment. Instead of specifying static holding times for one or a few discrete events, the Flow Duration standard manages runoff discharge over the full range of runoff flow levels predicted through continuous hydrologic simulation modeling, based on a long-term precipitation record. Flow Duration Control requires that the increase in surface runoff resulting from new impervious surfaces be **retained on-site with gradual discharge** either to groundwater through infiltration, losses by evapotranspiration, and/or discharge to the downstream watercourse at a level below the critical flow that causes creek channel erosion. **Critical flow**, or  $Q_c$ , is the lower threshold of in-stream flows that contribute to sediment erosion and sediment transport or effective work. The duration of channel flows below  $Q_c$  may be increased indefinitely without significant contribution to hydromodification impacts.

#### Key Point

The duration of channel flows below the “critical flow” may be increased indefinitely without significant contribution to hydromodification impacts.

### 7.5.2 Application of Flow Duration Control to Project Areas

The Flow Duration approach involves a continuous model that applies a time series of at least 30 years of rainfall records to a watershed area or project site to generate a simulated stormwater runoff record based on two sets of inputs, one representing future development and the other representing pre-project conditions. The 30-year precipitation record is the minimum length necessary to capture the range of runoff conditions that are cumulatively responsible for most of the erosion and sediment transport in the watershed, primarily flow levels that would recur at average intervals of 10 years or less in the pre-project condition. The design objective is to **preserve the pre-project cumulative frequency** distribution of flow durations and sizes under post-project flows. This is done with a combination of site design, infiltration and detention. Typically, the post-project increase in surface runoff volume is routed through a **flow duration control basin** or other structure that detains a certain portion of the increased runoff and discharges it through a **specialized outlet structure** (see Figure 7-5).

The flow duration basin, tank or vault is designed conceptually to incorporate multiple pools that are filled with different frequencies and discharge at different rates. The low-flow pool is the bottom level designed to capture and retain small to moderate size storms, the initial portions of larger storms, and dry weather flows. These flows are discharged through the lowest orifice which allows continuous **discharge below the critical flow rate** for a project ( $Q_{cp}$ ). Successively higher-flow pools store and release higher but less frequent flows through other orifices or graded weir notches to approximate the pre-project runoff durations. In practice the multiple pools are usually integrated into a

**Key Point**

Flow Duration facilities are subject to **Operations and Maintenance** reporting and verification requirements similar to those for numerically sized treatment measures.

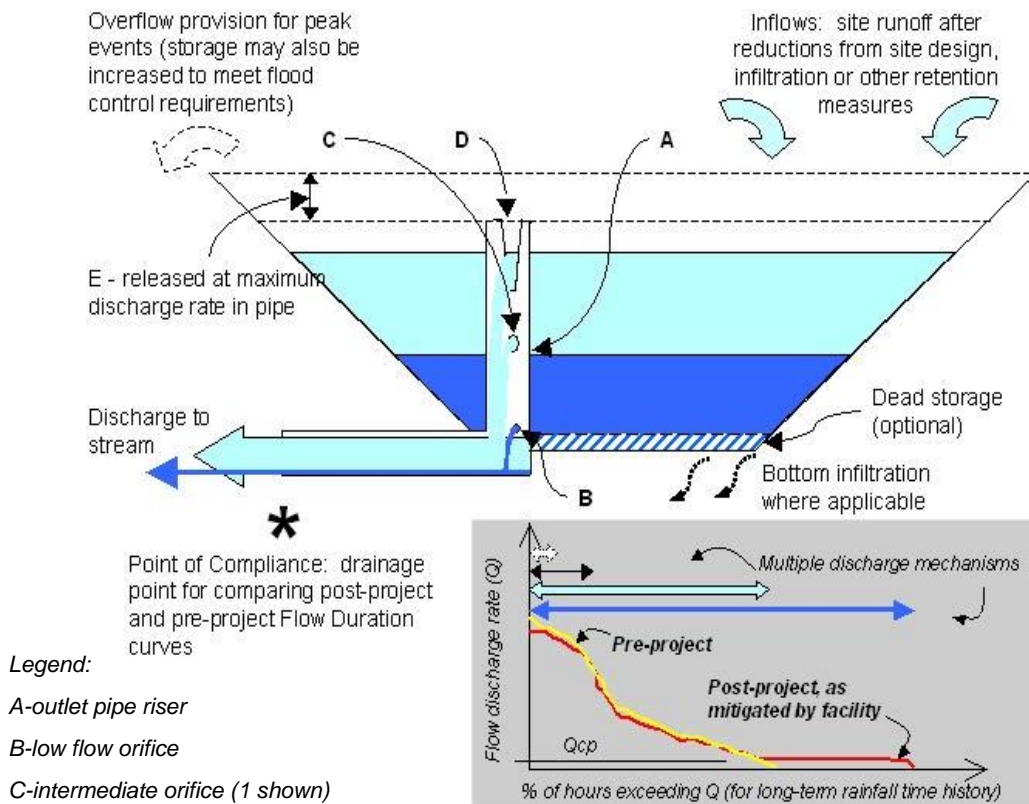


Figure 7-5: Schematic flow duration pond and flow duration curves matched by varying discharge rates according to detained volume. (Source: ACCWP, 2006)

single detention basin, tank or vault that works as a unit with the specialized outlet structure. Matching the pre-project flow durations is achieved through fine-tuning of the number, heights and dimensions of orifices or weir notches, as well as depth and volume of the basin, tank or vault.

As shown in the example chart of Figure 7-5, the post-project flow duration curve (red, or dark line) is reduced by the facility to remain **at or below the pre-project curve** (yellow, or light line), except for flows less than  $Q_{cp}$ . Minor exceedances are permissible at a limited number of higher flows since at other flow levels the post-project duration is actually less than the pre-project condition.

Adequate maintenance of the low-flow orifice or notch is critical to proper performance. The outlet may be in a protective enclosure to reduce risk of clogging. Please note that Flow Duration facilities are subject to Operations and Maintenance verification requirements similar to those for numerically sized treatment measures.

### 7.5.3 Bay Area Hydrology Model (BAHM)

To facilitate the simulation modeling aspect of FDC for project applicants and their engineers, the Countywide Program collaborated with the Santa Clara and Alameda counties' stormwater programs in 2007 to develop a **Bay Area Hydrology Model (BAHM) software package**<sup>46</sup> that is adapted from the Western Washington Hydrology Model (WVHM) developed by Clear Creek Solutions for the State of Washington Department of Ecology (WDOE). The WVHM was specifically developed to help engineers design facilities to meet a Flow Duration Control standard for development projects. The BAHM was updated in 2023 to include Contra Costa County data, extended rainfall records, and other enhancements.

The BAHM includes:

- Databases to automatically assign default rainfall conditions for a project location selected within the County boundary.
- A user interface for developing a **schematic drainage model** of the project site, with forms for entering areas of land use or impervious surface for multiple sub-basins.
- Continuous simulation modeling of **pre-project and post-project runoff** from the site using actual long-term rainfall records appropriately scaled for the project location.
- Simulation of **LID site design and treatment measures**, to estimate the reduction in runoff flow and volume achieved by these measures.
- A design module for sizing a **FDC detention facility** and designing the discharge structure to meet the Flow Duration standard for matching post-project and pre-project duration-frequency curves. Pre-project and post-project runoff are compared at a "point of compliance" selected by the designer, usually near the point where runoff leaves the project area.
- Standardized output **report files** that can be saved in Word format, and include all information about data inputs, model runs, facility design, and summary of the hydrological statistics showing the compliance of post-project flow duration curves with the Flow Duration standard. Project input and output data can also be saved in Excel and other formats for other uses.

---

<sup>46</sup> The most recent version of the BAHM and the BAHM User Manual are available for download at: <https://www.clearcreeksolutions.info/downloads>

## 7.6 HM Control Design Process

If the project is not exempt from HM requirements, it has the potential to cause hydromodification impacts on the receiving stream and must use the HM standards to determine how it will meet the management objective. Implement the following steps to design HM controls for non-exempt projects.

1. **Compare pre- and post-development runoff patterns.** Use the BAHM to perform a detailed analysis comparing pre-project and post-project runoff patterns for the project site. If a more detailed or site-specific approach is preferred, as an alternative to using the BAHM, then flow duration curves must be generated, illustrating the distribution of flows resulting from a continuous rainfall record for the pre- and post-project conditions. This is accomplished using a continuous simulation hydrology model or a sizing tool based on a continuous simulation model. ***The input data and results of the BAHM or other model analyses and the flow duration matching curves must be submitted to the municipality as part of the project's Stormwater Management Plan.***
2. **Incorporate the site design, treatment, and flow duration control measures into the project design.** Use the BAHM to design flow control facilities to meet the flow duration control criteria, so that the discharge pattern produced by the proposed flow duration control measures matches the pre-development flow duration curve. As an alternative to using the BAHM, a continuous simulation hydrology model or sizing tool based on a continuous simulation model must be used, preferably the same model or tool used in step 1, above. Achieving the flow duration control criteria generally requires some type of above- or below-ground detention and/or infiltration facilities that reduce the volume and control the rate of post-project discharge.
3. **If necessary, consider alternatives to on-site HM control.** On-site stormwater detention and infiltration facilities may not be suitable for the project site due to space limitations, soil conditions, depth to groundwater, and other factors. If the on-site HM control alternatives are constrained for the project, then a combination of on-site, off-site, and/or in-stream measures may need to be considered to meet HM requirements. Remember that site design measures and LID treatment measures will help meet HM requirements by reducing post-project runoff volumes and peak flows.
4. **Optimize the orifice of the HM facility.** The diameter of the low-flow (bottom) orifice is an important design parameter for flow duration facilities, since flows discharged from this outlet must be at or below the critical flow rate for the project ( $Q_{cp}$ ). However, maintenance and/or other considerations may dictate a practical limit to how small this orifice may be. In Western Washington, which has been implementing HM control requirements since 2001, the minimum orifice diameter specified in its Stormwater Management Manual is 0.5 inches, for orifices that have protective screens and a sump below that collects sediment<sup>47</sup>. If the BAHM or other model indicates that the flow duration matching criteria cannot be achieved with an orifice diameter of 0.5 inches, design options include:
  - a. Increasing the drainage area to the HM facility (e.g., combining flows from two or more drainage management areas);
  - b. Reducing the depth of the detention facility (that is, increase the surface area) to reduce the head on the orifice;
  - c. Adding a flow throttling device such as an elbow restrictor; and/or

<sup>47</sup> Washington State Department of Ecology, Feb. 2005. *Stormwater Management Manual for Western Washington*, Volume III – Hydrologic Analysis and Flow Control Design. <http://www.ecy.wa.gov/programs/wq/stormwater/manual.html>

- d. Add an infiltration measure downstream of the detention facility to further mitigate flows from the low-flow orifice.

Appendix D of the BAHM User Manual provides more information on how to size a flow duration facility with a specified minimum orifice size<sup>48</sup>. The Western Washington Manual provides more detail on orifice design.

5. **Design for maintenance of the HM facility.** HM facilities, like treatment measures, should be designed with maintenance considerations in mind. Design guidance for detention basins is provided in Chapter 6. Detention basins and underground vaults need safe access for personnel and equipment to perform required maintenance. Detention basins typically require a maintenance ramp leading to the bottom of the basin and a perimeter access road. Underground vaults require sufficient manhole openings and spacing with appropriate railings and ladders for access.

**Adequate maintenance of the low-flow orifice** is critical to proper performance. Outlet protection, such as a screen, is recommended to reduce risk of clogging. For example, Caltrans detention basin design standards call for a welded stainless steel wire mesh attached to a frame that wraps around the outlet riser<sup>49</sup>. Note that HM facilities are subject to the MRP operations and maintenance verification requirements and will be inspected by municipal staff. Property owners should be familiar with maintenance requirements and perform activities routinely. More information on maintenance of detention basins is provided in Chapter 8.

---

<sup>48</sup> Clear Creek Solutions, 2013. *Bay Area Hydrology Model User Manual*. Prepared for the Alameda Countywide Clean Water Program, the San Mateo Countywide Water Pollution Prevention Program, and the Santa Clara Valley Urban Runoff Pollution Prevention Program. <https://www.clearcreeksolutions.info/bahm-download-page>

<sup>49</sup> Ibid.

## 7.7 HM Control Submittals for Review

Determine the potential applicability of the HM requirements to the proposed project, using the guidelines in Section 7.3 and the applicability maps in Appendix H, and indicate HM applicability on the municipality's C.3 and C.6 Development Review Checklist (or equivalent form). Then prepare an HM Control Plan as part of the project's Stormwater Management Plan.

Table 7-1 provides a model checklist of submittal requirements for the HM Control Plan. Information on site design and LID treatment measures should also be included, if they are part of the HM Control Plan, along with any modeling analyses. The local jurisdiction should be consulted to determine the specific requirements for the project.

Table 7-1: HM Control Plan Checklist

Required?*		Information on Plan Sheets
Yes	No	
<input type="checkbox"/>	<input type="checkbox"/>	Soil types and depth to groundwater.
<input type="checkbox"/>	<input type="checkbox"/>	Existing and proposed site drainage plan and grades.
<input type="checkbox"/>	<input type="checkbox"/>	Drainage Management Area (DMA) boundaries
<input type="checkbox"/>	<input type="checkbox"/>	Amount of existing pervious and impervious areas (for total site and each DMA)
<input type="checkbox"/>	<input type="checkbox"/>	Amount of proposed impervious area (for total site and each DMA)
<input type="checkbox"/>	<input type="checkbox"/>	Amount of proposed pervious area (for total site and each DMA)
<input type="checkbox"/>	<input type="checkbox"/>	Proposed site design measures to minimize impervious surfaces and promote infiltration**
<input type="checkbox"/>	<input type="checkbox"/>	Proposed locations and sizes of stormwater treatment measures and HM controls
<input type="checkbox"/>	<input type="checkbox"/>	Stormwater treatment measure and HM control measure details
		<b>Additional Submittal Information</b>
<input type="checkbox"/>	<input type="checkbox"/>	BAHM Report with input and output data files in native software format, PDF format and additional files as required by municipality
<input type="checkbox"/>	<input type="checkbox"/>	If different model is used, description of the model, input and output data
<input type="checkbox"/>	<input type="checkbox"/>	Description of any changes to standard parameters (for example, scaling factor, duration criteria)
<input type="checkbox"/>	<input type="checkbox"/>	Comparison of HM facility sizing per model results vs. details on plan
<input type="checkbox"/>	<input type="checkbox"/>	Description of any unique hydraulic conditions due to HM facility location
<input type="checkbox"/>	<input type="checkbox"/>	Description and details of orifice/weir sizing, outlet protection measures, and drawdown time
<input type="checkbox"/>	<input type="checkbox"/>	Preliminary maintenance plan for HM facility
* Municipal staff may check the boxes in the "Required" column to indicate which items are required for the project.		
** Site design, treatment and HM measures that promote infiltration should be designed consistent with the recommendations of the project geotechnical engineer.		

## 7.8 Area-Specific HM Provisions

Individual municipalities may have special policies or ordinances for creek protection applicable in all or part of their jurisdictions. **Local municipal staff should be contacted** to identify any special local jurisdictional provisions that may encourage or affect specific forms of HM implementation. Examples of area-specific HM provisions can include:

- Watershed-based land-use planning measures, such as creek buffers, which may be incorporated in local General Plans, zoning codes or watercourse ordinances.
- Special permitting provisions for project design and review of projects on streamside properties.
- Specific plans for regional HM measures or in-stream restoration projects.

### Contact

Some municipalities may have special policies or ordinances for **creek protection**.

Contact the local jurisdiction to learn more.



# Chapter 8: Operation and Maintenance

<i>Introduction</i> .....	8-2
<b>8.1</b> <i>Summary of O&amp;M Requirements</i> .....	8-4
8.1.1 Responsibility for Maintenance .....	8-4
8.1.2 Considerations When Selecting Treatment Measures .....	8-4
8.1.3 O&M Documentation Required with Permit Application .....	8-6
8.1.4 Maintenance Agreement or Other Maintenance Assurance .....	8-6
8.1.5 Ongoing Inspections and Maintenance .....	8-7
<b>8.2</b> <i>Preparing Maintenance-Related Documents</i> .....	8-7
8.2.1 Standard Treatment Measure O&M Report Form .....	8-8
8.2.2 Maintenance Plan .....	8-8
<b>8.3</b> <i>General Landscape Maintenance Activities</i> .....	8-9
8.3.1 General Guidance .....	8-9
8.3.2 Regenerative Landscaping and Integrated Pest Management .....	8-11
<b>8.4</b> <i>Specific Maintenance Activities by Treatment Measure</i> .....	8-15
8.4.1 Bioretention Areas (Chapter 6.1) – Common Maintenance Concerns .....	8-15
8.4.2 Flow-Through Planters (Chapter 6.2) – Common Maintenance Concerns .....	8-17
8.4.3 Tree Well Filters (Chapter 6.3) – Common Maintenance Concerns .....	8-18
8.4.4 Infiltration Trenches (Chapter 6.4) – Common Maintenance Concerns .....	8-19
8.4.5 Extended Detention Basins (Chapter 6.5) – Common Maintenance Concerns .....	8-21
8.4.6 Pervious Pavement (Chapters 6.6 and 6.7) – Common Maintenance Concerns .....	8-22
8.4.7 Rainwater Harvesting (Chapter 6.9) – Common Maintenance Concerns .....	8-23
8.4.8 Media Filters (Chapter 6.10) – Common Maintenance Concerns .....	8-24

## Introduction

This C.3 Regulated Projects Guide provides recommendations on how to meet the inspection and reporting requirements concerning O&M of regulated projects. Additional guidance and documents can be found in Appendices A (Plant List) F (Mosquito Controls) and G (Maintenance Plan Templates). **For additional practical examples of maintenance inspections and guidance on maintenance activities for a variety of treatment designs and site conditions, refer to Chapter 6 of the GI Design Guide.**

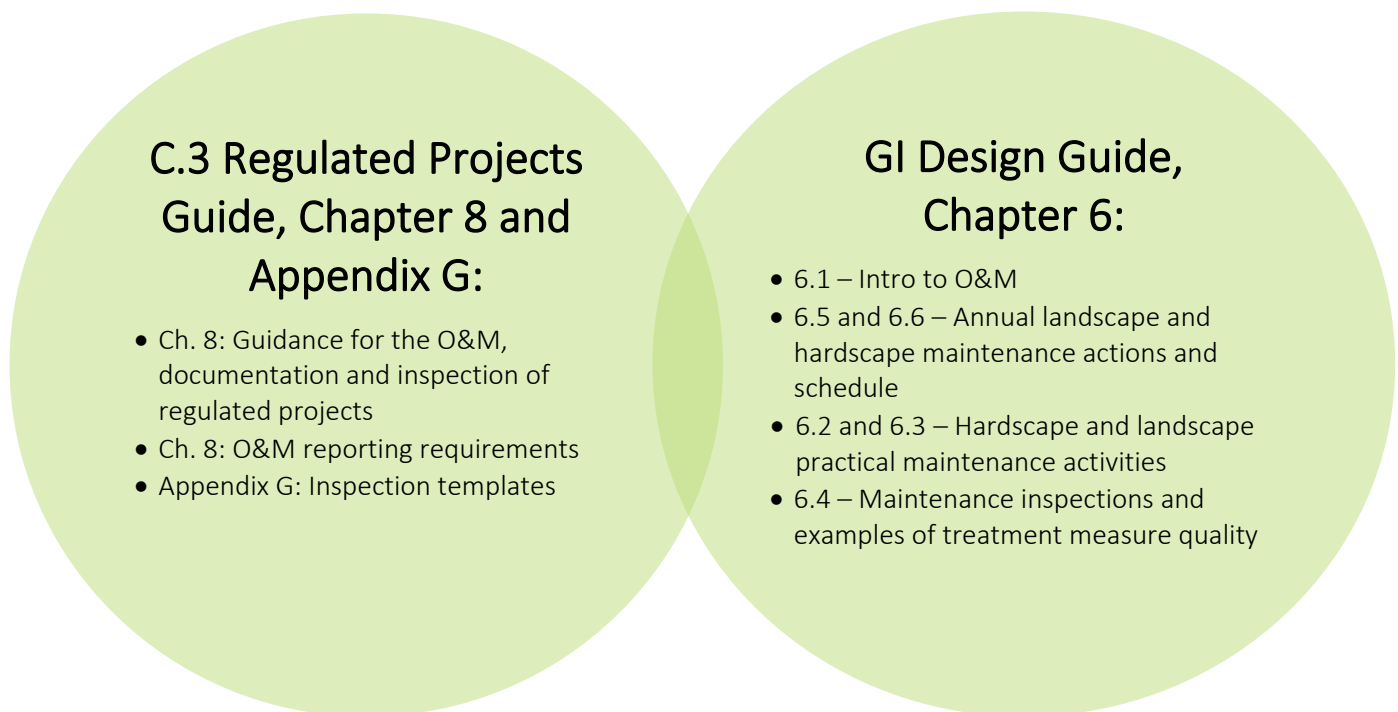


Figure 8-1: Chapter 8 and Appendix G details and cross-references to the GI Design Guide

### Remember

Thresholds for determining whether Provision C.3 applies to a project (in which case the project is a “C.3 Regulated Project”) are based on the amount of impervious surface that is created and/or replaced by a project, as described below.

- Beginning **July 1, 2023**, the threshold for requiring stormwater treatment is 5,000 square feet or more of impervious surface for all project types except certain single family homes.
- Detached single family home projects that are not part of a larger plan of development are regulated when they create and/or replace 10,000 square feet of impervious surface.

In addition to these thresholds, there are size thresholds for implementing site design measures - but not stormwater treatment or hydromodification management measures - for the following smaller project types:

- Small projects that create and/or replace between 2,500 square feet and 5,000 square feet of impervious surface; and
- Detached single-family home projects that create and/or replace between 2,500 square feet and 10,000 square feet of impervious surface.

## 8.1 Summary of O&M Requirements

O&M is essential for assuring that stormwater control measures required for the project (e.g., pervious pavement, site design, stormwater treatment and hydromodification management (HM) measures) continue to function effectively and do not cause flooding, provide habitat for mosquitoes, or otherwise become a nuisance. The O&M requirements described in this chapter apply to **pervious pavement, stormwater treatment measures, and HM measures** included in the project; however, site design measures can also be included in the O&M requirements for a site. The O&M process can be organized into five phases, as described below:

- Determining ownership and O&M responsibility;
- Identifying O&M requirements when selecting control measures;
- Preparing the O&M plan and other documentation;
- Executing an O&M agreement or other O&M assurance; and
- Ongoing inspections and O&M activities.

### Key Point

O&M requirements for treatment measures also **apply to HM measures** where and when they are implemented.

### 8.1.1 Responsibility for Maintenance

The responsibility for the O&M of stormwater control measures **belongs to the project applicant and/or property owner** unless other specific arrangements have been made. O&M responsibility for stormwater control measures should be considered at the earliest stages of project planning, typically at the pre-application meeting with municipal staff. The municipal stormwater permit also requires that the project applicant provide a signed statement accepting responsibility for O&M (or comply with another legally enforceable mechanism) until this responsibility is legally transferred, as well as ensuring access to municipal, Water Board, and San Mateo County Mosquito Abatement District staff to inspect the control measures.

### Key Point

Unless specified otherwise, the responsibility for maintenance of stormwater control measures **belongs to the project applicant and/or property owner**.

### 8.1.2 Considerations When Selecting Treatment Measures

#### O&M Needs

When determining which types of control measures to incorporate into project plans, be mindful of how maintenance intensive they are. Review O&M requirements for LID systems and study the operation manual for any manufactured, proprietary system. Control measures must be maintained so that they continue to treat stormwater runoff effectively **throughout the life of the project** and do not provide habitat for mosquito breeding. Adequate funds must be allocated to support long-term maintenance. Some systems will hold standing water if they are not maintained correctly, and frequent maintenance may be needed to avoid health/vector concerns. Vault-based systems are hidden from sight and can have special confined-entry considerations which should be taken into account. A properly designed and established bioretention area, by contrast, may require little maintenance beyond what is required for normal

landscaped areas. However, the maintenance obligation will vary depending on the system design. The plant palette for bioretention systems is usually different from that used in non-stormwater types of landscapes and can require different maintenance practices. For example, some rushes, reeds, sedges and bunch grasses will be healthiest if they are not trimmed at all - they can be damaged if trimmed or sheared in the same way that some other plants are maintained.

The party responsible for maintenance will also be required to **dispose of accumulated residuals properly**. Residuals such as trash, filter media, and fine sediments collected from treatment measures may or may not be contaminated. At present, research generally indicates that residuals are not hazardous wastes and as such, after dewatering, property owners can generally dispose of residuals in the same way they would dispose of any uncontaminated soil.

A list of **landfills in San Mateo County** that accept sediment (“soil”), contaminated or otherwise, is available at <https://www2.calrecycle.ca.gov/SolidWaste/Site/Search>. If there are proprietary treatment devices onsite, property owners may choose to contract with the treatment device manufacturer to maintain these treatment measures. Services typically provided include inspection, maintenance, handling and disposal of all residuals.

### Mosquito Controls

When selecting and installing stormwater treatment devices, the various environmental, construction, and local factors that may influence mosquito breeding will need to be considered. Except for certain treatment measures designed to hold permanent pools of standing water, treatment measures should **drain completely within five days** to effectively suppress mosquito production. The Countywide Program’s Vector Control Plan includes mosquito control design guidance and maintenance guidance for treatment measures. This guidance is included in Appendix F.

#### Warning

Except for treatment measures designed to hold permanent pools of standing water, **treatment measures should drain completely within five days** to suppress mosquito production.

### Access to Municipal Staff

#### Remember

Make sure stormwater treatment measures and HM measures are readily accessible to inspectors.

The O&M agreement or other maintenance assurance for the project will need to guarantee access permission for staff from the local municipality, the [San Mateo County Mosquito and Vector Control District](#), and the Water Board to enter the property to verify that maintenance is being conducted in accordance with the maintenance plan, throughout the life of the project. Stormwater control measures must be **readily accessible to the inspectors**, and municipal staff should be contacted to determine whether easements will be needed. Stormwater control measures must also be accessible to equipment needed to maintain them. Maintenance needs vary by the type of control measure that is used. The maintenance requirements described in Section 8.2 should be reviewed to identify the accessibility needs for maintenance equipment. It is generally more difficult to provide adequate and safe access for maintenance of below-ground control measures than above-ground control measures.

### 8.1.3 O&M Documentation Required with Permit Application

As part of the building permit application, Regulated Project applicants typically need to prepare and submit the documents listed below. **The local jurisdiction should be consulted** for specific requirements.

- A legible conceptual plan of the site, clearly showing the locations of pervious pavement, stormwater treatment, and HM measures. The plan should specifically identify all pervious pavements systems that total 3,000 ft.<sup>2</sup> or more (excluding private-use patios for single-family homes, townhomes, or condominiums). Letter-sized plans are preferred; legal-sized plans may be accepted.
- A legal description of the property
- Detailed maintenance plan for pervious pavement, stormwater treatment, and HM measures, including inspection checklists, as appropriate.
- O&M information from the manufacturer for any proprietary control measures installed on the site.
- A standard O&M report form, to be attached to a maintenance agreement or other maintenance assurance.
- As-built cross section and plan view details of the stormwater control measures installed on the site.

Please note that requirements may vary from one jurisdiction to another. Some jurisdictions may not need to have the draft O&M agreement submitted until later in the construction phase, but all should have the O&M agreement or other maintenance assurance document(s) signed and notarized before any certificates (temporary or final) of occupancy are issued. Ask municipal staff if there are any additional requirements. Appendix G includes templates to assist project applicants in preparing their standard treatment measure O&M report form and maintenance plan. Guidance on preparing these documents is provided in Section 8.2.

#### Contact

The local jurisdiction should be contacted for inquiries about documents required for building permit applications.

### 8.1.4 Maintenance Agreement or Other Maintenance Assurance

Where a property owner is responsible for maintenance, the property owner of regulated projects is typically required to enter into a maintenance agreement with the municipality to ensure long-term maintenance of stormwater control measures. The agreement will usually be **recorded against the property** to run with the title of the land. The local jurisdiction should be contacted to obtain a copy of the standard maintenance agreement. The maintenance agreements require property owners to ensure that the control measures are being operated properly in perpetuity, regular maintenance inspections of all stormwater control measures are being conducted, necessary maintenance activities are completed, and – depending on the municipality – annual submittals of a Standard Treatment Operation and Maintenance Inspection Report form to the municipality are completed. Alternatively, some jurisdictions do not record O&M agreements and instead use Conditions of Approval and their municipal code to require property owners to operate and maintain stormwater control measures and provide access to municipal inspectors. Some municipalities may also require maintenance assurance through the means of a financial instrument

such as a bond or security deposit that is held for a period of time to ensure that maintenance obligations can be paid for if the property owner or developer is unable to perform that duty in the future.

For **residential properties** where the stormwater control measures are located within a common area that will be maintained by a homeowner's association, language regarding the responsibility for maintenance must be included in the project's conditions, covenants and restrictions (CC&Rs). Printed educational materials regarding on-site stormwater controls are typically required to be included with the first, and any subsequent, deed transfer. The educational materials typically:

- Explain the post-construction stormwater controls requirements;
- Provide information on what stormwater controls are present;
- Describe the need for maintenance;
- Explain how necessary maintenance can be performed; and
- For the initial deed transfer, describe the assistance that the project applicant can provide.

If stormwater control measures are proposed to be located in a **public area** for transfer to the municipality, these control measures must meet the design guidelines specified in Chapter 6 and will remain the property owner's responsibility for maintenance until the control measures are accepted for transfer.

### 8.1.5 Ongoing Inspections and Maintenance

After the maintenance agreement is executed, or the municipality approves other maintenance assurance such as CC&Rs, the party responsible for maintenance begins to implement the maintenance plan. Inspection reports are submitted to the municipality as required by the maintenance agreement or other maintenance assurance.

The municipality, Water Board, and San Mateo County Mosquito and Vector Control District may conduct **operation and maintenance verification inspections** to make sure that stormwater control measures are being maintained. In the event adequate maintenance is not conducted, the municipality will either take an enforcement action against the responsible party or take necessary steps to restore the control measures to good working order. The property owner will be responsible for reimbursing the municipality for expenditures associated with restoring the control measures to good working order.

#### Warning

The municipality, Water Board and San Mateo County Mosquito and Vector Control District staff may conduct **O&M verification inspections** to make sure that stormwater control measures are maintained.

## 8.2 Preparing Maintenance-Related Documents

This section provides instructions for preparing the following documents that are typically required as parts of the building permit application, if the project is a regulated project and includes pervious pavement (3,000 sq. ft. or more), stormwater treatment measures and/or HM measures:

- A standard control measure O&M report form
- A maintenance plan, including a schedule of maintenance activities.

### 8.2.1 Standard Treatment Measure O&M Report Form

The municipality may require the property owner, or other responsible party, to submit an annual report summarizing the maintenance and inspections of control measures included in the project. To standardize and simplify the reporting process, the property owner submits a “Standard Treatment Measure O&M Report Form” with the building permit application, and the municipality includes the report form as an Exhibit to the maintenance agreement. After the agreement is executed, the property owner, or other responsible party, uses this form to prepare the annual report, which is typically submitted by December 31 of each calendar year or annually before the rainy season begins on October 1st. When submitting the completed report form each year, the responsible party will typically be required to attach the inspection forms that were completed during that calendar year.

To assist with preparation of the Standard Treatment Measure O&M Report Form, a template is included in Appendix G. ***The local jurisdiction should be consulted*** for an electronic version of the template. When using the template to prepare the report form, project-specific information should be inserted where indicated by highlighted prompts such as the following: `[[= insert name of property owner/responsible party =]]`

### 8.2.2 Maintenance Plan

The maintenance plan must be sufficiently detailed to demonstrate to the municipality that pervious pavement, stormwater treatment measures, and/or HM measures will receive ***adequate inspections and maintenance*** to continue functioning as designed over the life of the project. A maintenance plan typically includes the following elements:

- Contact information for the property owner or other responsible party.
- Project address and, if required, the Assessor’s Parcel Number and directions to the site.
- Identification of the number, type and location of all pervious pavement (3,000 sq. ft. or more), stormwater control, and/or HM measures on the site.
- A list of specific, routine maintenance tasks that will be conducted, the intervals at which they are conducted (e.g., “Inspect control measure once a month, using the attached checklist”), required practices (e.g., use compost, wood mulch and other regenerative landscaping practices such as those from ReScape), and prohibited practices such as the use of pesticides or synthetic fertilizers.
- An inspection checklist, specific to the control measure(s) included in the project, which indicates the items that will be reviewed during regular maintenance inspections. Completed inspection forms may be required as part of the annual Stormwater Control Measure O&M Report, described in Section 8.2.1.

The following materials are available to assist with preparing the maintenance plan:

- Maintenance plan templates included in Appendix G.
- A list of common maintenance concerns for frequently used stormwater control measures (see the following pages).



When using a template to prepare the report form, project-specific information should be inserted where indicated by prompts such as: `[[= insert name of property owner/responsible party =]]`. The templates include sample inspection checklists for some control measures. If the project includes different control measures, then the template will need to be customized. To prepare the maintenance plan, the **control measure-specific maintenance information** provided in Sections 8.3 and 8.4 should be referred to.

### Key Point

Refer to the **control measure-specific maintenance information** to prepare the maintenance plan.

## 8.3 General Landscape Maintenance Activities

### 8.3.1 General Guidance

#### Overview of Landscaped Treatment Measure Maintenance Activities

Frequency of site visits and required maintenance practices will vary depending upon the stormwater measure and plant selection. Maintenance shall include watering, cultivation, weeding and pruning as necessary to maintain optimum growth conditions and, as appropriate to the specific stormwater measure, to keep the planted areas neat and attractive in appearance. In all instances, controlling weeds and unwanted growth with chemical applications is prohibited.

The contractor installing the treatment measure should be familiar with the design and function of the specific stormwater measure(s) to ensure that the plantings are maintained appropriately and do not interfere with the efficient runoff drainage and filtration.

Ongoing management of invasive weed species will be required in all applications. Monthly hand weeding will allow the naturalized vegetation to take hold, and will ultimately be less costly than less frequent, and more intensive clearing. Regular application of composted mulch (also known as aged mulch) or other mulch material that will resist floating with surface runoff, will also help control weed growth. “Micro-bark” and “gorilla hair” mulches are not recommended.

#### Erosion Control

With landscapes that are not fully established, maintenance staff will need to monitor and evaluate potential for erosion and sediment accumulation in the runoff, which will influence irrigation scheduling, and determine the need for additional erosion control measures. Soil can be protected from erosion by a number of methods including:

- Keep the soil covered with vegetation to the greatest extent possible;
- Slow water runoff by using compost berms, blankets or socks along slopes;
- Cover bare soil with a minimum 3-inch layer of Biotreatment Wood Mulch<sup>50</sup>;
- Minimize the use of leaf blowers in planting beds and on turf;

---

<sup>50</sup> See Chapter 6 and the [Biotreatment Wood Mulch specification](http://www.flowstobay.org/newdevelopment) on the Flowstobay website: [www.flowstobay.org/newdevelopment](http://www.flowstobay.org/newdevelopment)

- On slopes, use composted arbor mulch that is not prone to washing into storms drains; and
- Store leaf litter as additional mulch in planting beds as appropriate.

### Irrigation Systems

Where irrigation systems have been installed for temporary or permanent irrigation, maintain the irrigation system for optimum performance, per manufacturer's specifications. Inspect the entire system on an ongoing basis, including cleaning and adjusting all sprinkler and bubbler heads, drip emitters and valves for proper coverage. Monitor the irrigation system while operating to identify and correct problems with water runoff or standing water.

Monitor soil moisture within plant root zones using a soil probe or shovel and adjust irrigation schedules accordingly if a soil moisture sensor is not being utilized to signal the irrigation controller. If a Weather-Based Irrigation Controller (WBIC), otherwise known as a "Smart" Controller, is not utilized on the project, irrigation should be scheduled using a water budget approach, basing irrigation frequency on evapotranspiration data (ET) to avoid over-irrigation of plant material. Adjust irrigation frequency within each hydrozone area a minimum of every four weeks to respond to expected adjustments in ET data.

Standard turf mixes are not recommended, but if sod is used, consider a no-mow native grass type such as a bioretention sod<sup>51</sup>. If mowing is needed, implement grasscycling, where appropriate in the stormwater treatment measure. Grass clippings should not be carried into drainage structures. Refer to "A Landscaper's Guide to Grasscycling" available from StopWaste.Org.

### Bioretention and Other Vegetated Treatment Measures

In bioretention areas, undesirable and/or invasive plant species should be carefully monitored and controlled to reduce competition with the desired plantings and to assure the success of the revegetation activities. The establishment of undesirable and/or invasive species can be partially controlled during the establishment period by implementing the watering schedule of initial saturation followed by alternating periods of shallow inundation and dry soil. Manual methods of undesired plant removal should be conducted on the bottom, edge and side of the areas when they are not inundated.

Undesired plant removal should be conducted regularly the first two years to prevent the growth, flowering, and seed set of undesirable and/or invasive species. After the first two years, plant removal frequency will vary on a site-specific basis as determined by the type and seasonal growth cycle of the undesired species. In general, plant removal as often as once a month may be necessary to avoid more extensive and costly eradication in the future.

Long-term maintenance tasks will include continued control of undesirable and/or invasive plants, and control of erosion. Erosion could include gullies, rills and sheet erosion. Actions to control erosion should include redirecting or dissipating the water source. Recontouring and subsequent mulching and/or replanting may be required in bare areas. In the event of extensive die-off of the desired plant species, the bare areas should be replanted. Where the event that caused plant mortality was not a natural catastrophic occurrence, the site condition that resulted in the die-off should be investigated and remedial action to correct the problem should be undertaken prior to replanting.

For detailed treatment measure-specific guidance, see Section 8.4.

---

<sup>51</sup> No-mow native grass [Biofiltration Sod](#) from Delta Blue Grass is one such product.

### 8.3.2 Regenerative Landscaping and Integrated Pest Management

This section provides a summary of Regenerative Landscaping principles and practices, which includes integrated pest management techniques, based on the landscaping guidelines at [www.ReScapeCa.org](http://www.ReScapeCa.org).

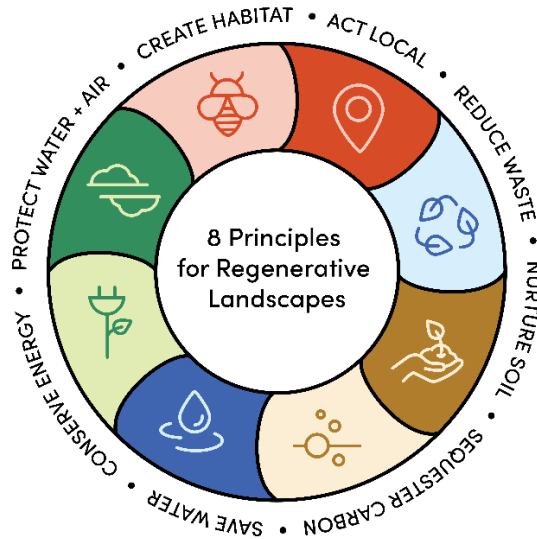


Figure 8-2: The 8 Principles of Regenerative Landscaping  
(Credit: ReScape, [rescapeca.org](http://rescapeca.org))

#### Regenerative Landscaping

The principles of regenerative landscaping, developed by the non-profit Bay Area based organization, ReScape (formerly known as the Bay-Friendly Landscaping Coalition), is a whole systems approach to the design, construction and maintenance of the landscape in order to support the integrity of the San Francisco Bay watershed. The landscaping practices address the fact that one input affects the whole. The principles foster soil health, conserve water, sequester carbon and protect valuable resources while reducing waste and preventing pollution. Project sponsors are encouraged to use landscape professionals who are familiar with and committed to implementing the regenerative practices from the initial plant selection through the long-term maintenance of the site. This section summarizes ReScape’s practices that may be implemented during design, construction, and maintenance of stormwater control measures, as well as information about how these practices can benefit water quality of the Bay and its tributaries.

Regenerative Landscaping is based on the eight principles shown in Figure 8-2 and further described below:

1. **Act Local.** Landscapes designed to be part of the larger ecosystem of the Bay Area can both protect the health, diversity and sustainability of this valuable resource while making the most of the natural processes of a well-functioning ecosystem. By selecting plants appropriate to the climate, exposure, soils, drainage and topography, plantings can be established more successfully with less consumption of resources and intensive maintenance. Landscape designers are also encouraged to use local, well-adapted plant communities as models and to consider the potential for fire when developing the plant palette for a project.
2. **Reduce Waste.** Reducing waste – and thus conserving landfill space and fossil fuel for hauling this material to the landfill - starts with not generating it in the first place. Pruning of plants can be

reduced by selecting plant species that can grow to their natural size in the space allotted them, by avoiding the use of sheared hedges as design elements and not specifying invasive species (go to [www.cal-ipc.org](http://www.cal-ipc.org)). Prune selectively and avoid excessive plant growth by applying water and fertilizer judiciously. The second step is to recognize the value of plant debris, and to keep this organic matter on the site, using it as a gardening resource for mulching and composting.

- 3. Nurture Soil.** Nurturing the soil means creating and protecting conditions for a diversity of beneficial soil organisms. Feeding the soil, not the plant, encourages a thriving community - a food web of microorganisms, worms and other beneficial creatures. One teaspoon of healthy soil can contain billions of beneficial bacteria and fungi. Living soil food web ecosystems can filter pollution, store water, provide plant nutrients, sequester carbon and help plants resist pests naturally. Returning organic matter to the soil, in the form of plant debris, is the link between protecting the soil and protecting the watershed. Healthy soil that is uncompacted and rich in organic matter is full of life and can store water and actively cycle nutrients, regulate and partition water flow, neutralize pollutants, and resist pests. The following practices will encourage a complex soil community of microorganisms, worms, and other beneficial creatures. Base the landscape design on a soil analysis and understanding of soil texture, structure and drainage. The following practices are recommended during construction:

- Protect topsoil in place or remove and store for re-spreading after grading;
- Limit construction traffic to areas that will not be landscaped to avoid soil compaction;
- Avoid soil erosion and manage sediment with compost-based best management practices;
- Amend soils with compost before planting; and
- Specify and maintain an adequate layer of composted wood mulch, taking into account water flow and designing treatment systems to avoid the loss of mulch with runoff.

Maintenance practices to benefit soils and the watershed include allowing grass clippings to remain on the lawn; feeding soils with naturally based products including compost and a water extract of mature compost, instead of synthetic, fast release fertilizers and avoiding pesticides.

- 4. Sequester Carbon.** As the amount of carbon dioxide in the atmosphere reaches new highs, solutions to the climate change crisis must come from every sector. Through photosynthesis, plants draw carbon dioxide out of the air. They use some of that carbon for growth and exude some of it through their roots to feed soil organisms. This process stabilizes the carbon in the soil, where it can reside for centuries. Applying compost to improve soil and plant health jump starts the conversion of atmospheric carbon to soil carbon. Compost increases the stored soil carbon by increasing the soil's water-holding capacity and improving conditions for beneficial soil microorganisms. This leads to greater plant growth and more stable carbon in the soil. Native perennial bunch grasses sequester more carbon in their roots and in the soil than invasive annual grasses.
- 5. Save Water.** Amending the soil with compost and keeping it covered with composted mulch (or other mulch that resists floating) can increase soil permeability and water-holding capacity, reduce water loss through evaporation and decrease the need for irrigation. Planting appropriate, drought-tolerant California natives or Mediterranean plants also reduces water consumption for irrigation, as well as consumption of other resources for mowing, fertilizing, and spraying. Minimize the use of traditional turf grasses for non-functional (decorative) areas as turf requires more irrigation and fertilizing to remain green and turf on slopes or in narrow, irregular hard to water shapes in hard to mow and irrigate efficiently. An exception to the use of turf is the use of "bioretention sod" which

uses native grasses to hold soil in place and treat stormwater. Arrange plants in “hydrozones” of low, medium or high-water demand. Onsite collection systems can allow the use of rainwater, or the reuse of “graywater” – uncontaminated wastewater from sinks, bathtubs, and washing machines. Specify, install and maintain high-efficiency irrigation systems, and train landscaping staff to manage irrigation according to need.

6. **Conserve Energy.** Conventional landscapes are very fossil-fuel consumptive. Selecting plantings that do not require regular mowing, pruning, fertilizing or watering can help reduce this demand and restore our landscapes to those that are more productive than consumptive. Tree plantings can be used to moderate building temperatures, and to shade paved areas and air conditioners. Trees can also intercept, treat and absorb significant amounts of rainfall each year and thus help control stormwater runoff. Specify as large a tree species as possible but be sure that it will be allowed to grow to its natural shape and size in the allotted space and is provided with enough soil volume. Outdoor lighting should be designed to use less energy and minimize “light pollution.” Choose and maintain energy-efficient landscaping equipment to conserve fuel. Specifying local products and suppliers reduces the energy needed to transport products and supports local economies.
7. **Protect Water & Air.** Regenerative landscaping can help protect water quality by increasing on-site infiltration and reducing runoff, reducing pollutants in runoff, and increasing the soil’s ability to remove pollutants from runoff. It can help protect air quality by reducing fossil fuel consumption, recycling plant debris onsite, and planting trees to remove carbon dioxide and absorb air pollutants. Practices such as minimizing decorative lawns, keeping soil covered with mulch, and planting trees play a critical role in protecting water and air quality. **An additional very important component of Regenerative Landscaping is reducing the use of pesticides through integrated pest management, which is described in a separate section, below.**
8. **Create Habitat.** Biodiversity is crucial to the health and resiliency of natural ecosystems. By using native plants and increasing the diversity of plant palettes, our built landscape provides food, water and shelter for birds, butterflies, pollinators, beneficial insects and other creatures - thus helping to conserve precious wildlife and restore damaged bionetworks. Although we tend to rely on parks and open space to preserve wildlife habitat, developed landscapes can also provide food, water, shelter and nesting sites for animals. This can be accomplished by providing a diverse landscape that includes annuals, biennials and perennials of many different sizes, shapes, colors and textures; by choosing California natives first; providing appropriate water and shelter for wildlife; eliminating the use of pesticides; and planning sites to conserve or restore natural areas and wildlife corridors.



*Figure 8-3: Protect pollinators and water quality with IPM (Credit EOA, Inc.)*

### Integrated Pest Management

An element of Regenerative Landscaping, Integrated Pest Management (IPM) is crucial to protecting the Bay Area’s water bodies. Some creeks in the Bay Area exceed water quality toxicity limits, primarily due to pesticides entering urban runoff. Water quality agencies recommend using IPM practices for maintaining stormwater control measures. IPM is a holistic approach to mitigating insects, plant diseases, weeds, and

other pests, therefore it fits well within the Regenerative Landscaping practices. Projects that require a landscaping plan as part of a development project application are required to use IPM, as indicated in each agency's source control measures list. Avoiding pesticides and synthetic fertilizers are particularly important when maintaining stormwater treatment measures, to protect water quality.

IPM involves the use of many strategies for first preventing and then controlling, but not eliminating, pests. It places a priority on fostering a healthy environment in which plants and soils have the strength to resist diseases and insect infestations, and out-compete weeds. These practices are part of Regenerative Landscaping Practices #1, 3, 7 and 8. Using IPM requires an understanding of the life cycles of pests and beneficial organisms, as well as regular monitoring of their populations. When pest problems are identified, IPM considers all viable solutions and uses a combination of strategies to control pests, rather than relying on pesticides alone. The least toxic pesticides are used only as a last resort. IPM features the following practices:

**Prevent Pest Problems.** Fostering a healthy soil and selecting appropriate plant communities for the site helps reduce the susceptibility to disease and other pests. Landscape designs should include a diversity of species that are well-suited to the site; specify resistant varieties and native species, including plants that attract beneficial insects; place plants a proper distance from buildings; avoid over-planting; and include compost in the soil specifications. Cultural methods of avoiding pests during construction and maintenance include the following:

- Selecting plant material that is free from disease and insects;
- Planting at the right depth;
- Watering thoroughly but not over-watering;
- Keeping mulch on the soil surface at all times, keeping it away from root crowns;
- Using slow-release fertilizer, if necessary, and not over-fertilizing;
- Pruning judiciously;
- Eliminating noxious weeds before they go to seed or spread;
- Cleaning equipment after use on infected plants;
- Inspecting and removing invasive plant parts or seeds from clothing, tools and vehicle before leaving an infected site; and
- Cleaning up fruit and plant material that is infected with insects or diseases.

**Watch for and Monitor Problems.** Agencies should provide their landscaping staff and contractors with the time and resources to learn to identify both pest and beneficial organisms, and train property owners to monitor and record pest problems. Plants should be checked often for vigor and signs of pests. Clarify which problems are the result of pests and not the result of other environmental problems. Evaluate the results of any treatments, and check regularly with the Bio-Integral Resource Center ([www.birc.org](http://www.birc.org)) or UC Davis ([www.ipm.ucdavis.edu](http://www.ipm.ucdavis.edu)) for up-to-date resources and information.

**Educate Property Owners.** Many property owners have unrealistic standards for pest control and need to learn how landscapes can tolerate a certain level of pests without resulting in significant, or even noticeable, damage. Landscape professionals should educate their clients and refer them to [www.ourwaterourworld.org](http://www.ourwaterourworld.org) for fact sheets and information on alternative pest control strategies.

**Use Physical and Mechanical Controls.** If pests are identified as the source of unacceptable levels of damage, physical barriers or mechanical techniques are the first line of control. This can include the

carefully timed and conducted pruning of infested plant material or removal of whole plants, spraying aphids with a strong jet of water, using pheromone or sticky traps to keep ants and other insects away or hand-picking large adult insect pests and larvae as they appear.

**Use Biological Controls.** Living organisms can also be used to keep pest populations under control. The most important biological controls appear naturally and will be abundant in a landscape that is not heavily treated with pesticides. Encourage beneficial insects by planting a wide range of plants that flower throughout the year (see the [ReScape website](#) for plant and pollinator resources and information) and introduce natural predators. Buy all biological controls from a reputable source, and do not use pesticides except as a last resort.

**Least Toxic Pesticides are a Last Resort.** The least toxic and least persistent pesticide is used only when monitoring indicates that preventative and non-chemical methods are not keeping pests below acceptable levels. Pesticides are not used on a calendar basis. When used, their efficiency is maximized by understanding the targeted pest and beneficial organism life cycles, by careful timing and targeted application.

## 8.4 Specific Maintenance Activities by Treatment Measure

### 8.4.1 Bioretention Areas (Chapter 6.1) – Common Maintenance Concerns

The primary maintenance requirement for bioretention areas is the regular inspection and repair or replacement of the control measure's components. Generally, the level of effort is similar to the routine, periodic maintenance of any landscaped area. It is recommended that certain maintenance tasks be conducted monthly or quarterly as required, annually before the rainy season, annually after the rainy season, and after large storm events.

Depending on the control measure needs, monthly or quarterly inspections should be conducted as follows:

- Inspect bioretention surface area, inlets and outlets for obstructions and trash; clear any obstructions and remove weeds and trash.
- Inspect bioretention areas for standing water. Presence of algae growth in ponded water is a good indicator of problems. In general, if standing water does not drain within 1 day, there may be a problem with the system. First check the cleanout riser (if there is one) and clean out any underdrains for clogging material. Other causes of standing water can include clogged outlets, faulty irrigation systems, and/or improperly specified or installed biotreatment soil media, mulch, or plant material. If needed, remove problematic materials and replace with approved biotreatment soil media, mulch, new plants and/or other components as needed. Compaction of native soil can also be a cause of standing water; in which case the whole system may need to be reconstructed. If mosquito larvae are observed, contact the San Mateo County Mosquito and Vector Control District through their on-line service request at <http://www.smcmvcd.org/request-service> or call the District at (650) 344-8592. Larvae will breed more quickly in warmer seasons.

Before and after the rainy season, an evaluation of the whole control system should be conducted, including the following activities:

## 8.4 Specific Maintenance Activities by Treatment Measure

- Prune and weed the bioretention area and remove trash. Remove and replace any dead plants.
- Inspect the vegetation to ensure that it is healthy and dense enough to provide filtering and protection from erosion. Do not use pesticides or other chemical applications to treat diseased plants, control weeds or remove unwanted growth.
- Inspect inlets for channels, exposure of soils, or other evidence of erosion. Clear any obstructions and remove any accumulation of sediment.
- Check the irrigation system to ensure that plants are receiving the correct amount of water. Repair or replace any improperly functioning equipment.
- Use compost and other natural soil amendments and fertilizers. Do not use synthetic fertilizers, especially if the system uses an underdrain.
- Inspect the energy dissipater at the inlet to ensure it is functioning adequately, and that there is no scour of the surface mulch. Remove any accumulation of sediment.
- Inspect and, if needed, replace wood or rock mulch depending on the site conditions. It is recommended that Biotreatment Wood Mulch<sup>52</sup> be applied once a year to maintain a 3" depth. Mulch should be added when erosion is evident or when the bioretention area begins to look unattractive. The entire area may need mulch replacement every two to three years, although spot mulching may be sufficient when there are random void areas. Rock mulch can be raked up or manually collected and redistributed after maintenance is performed.



Figure 8-4: Bioretention Area in Daly City (Credit: SMCWPPP)

After large storm events, the system should be inspected for:

- Erosion of biotreatment soil media, loss of mulch, standing water, structural failure, clogged overflows, weeds, trash and dead plants. If using rock mulch, check for 3" of coverage.

---

<sup>52</sup> See Chapter 6 and the [Biotreatment Wood Mulch specification](http://www.flowstobay.org/newdevelopment) on the Flowstobay website: [www.flowstobay.org/newdevelopment](http://www.flowstobay.org/newdevelopment)



For more guidance on how to conduct these maintenance tasks, **see visual aids provided in Section 6.4 of the GI Design Guide**. Specifically for bioretention areas, see detailed examples of: mulch application, hand weeding, plant coverage and health, visual safety, grass trimming, irrigation schedule and irrigation components condition, sediment load management, trash removal, and erosion control.

### *8.4.2 Flow-Through Planters (Chapter 6.2) – Common Maintenance Concerns*

Maintenance objectives include maintaining healthy vegetation at an appropriate size; avoiding clogging; and ensuring the structural integrity of the planter and the proper functioning of inlets, outlets, and the high-flow bypass. It is recommended that certain maintenance tasks be conducted monthly, annually before the rainy season, annually after the rainy season, and after large storm events.

Depending on the system needs, monthly inspections should be conducted as follows:

- Inspect the planter surface area, inlets and outlets for obstructions and trash; clear any obstructions and remove trash.
- Inspect the planter for standing water. Presence of algae growth in ponded water is a good indicator of problems. First check the cleanout riser and clear any underdrains of obstructions or clogging material. In general, if standing water does not drain within 1 day, there may be a problem with biotreatment soil media, mulch, outlets, cleanouts, underdrains, irrigation systems and/or plant material. If needed, remove problematic materials and replace with approved biotreatment soil media, mulch and new plants or appropriate materials. If mosquito larvae are observed, contact the San Mateo County Mosquito and Vector Control District through their on-line service request at [www.smcmvcd.org/online-service-request](http://www.smcmvcd.org/online-service-request) or call the District at (650) 344-8592. Larvae will breed more quickly in warmer seasons.
- Check for eroded or settled biotreatment soil media. Level soil with rake and remove/replant vegetation as necessary.

Before and after the rainy season, a complete evaluation of the system should be conducted:

- Ensure that vegetation is healthy and dense enough to provide filtering and protect soils from erosion. Prune and weed as necessary. Replace dead plants. Remove excessive growth of plants that are too close together to allow water flow and/or causing other issues. Remove trash and sediment. Do not use pesticides or other chemical applications to treat diseased plants, control weeds or remove unwanted growth.
- Use compost and other natural soil amendments and fertilizers. Do not use synthetic fertilizers, especially if the system uses an underdrain.
- Inspect the overflow pipe to make sure that it can safely convey excess flows to a storm drain. Repair or replace any damaged or disconnected piping. Use the cleanout riser to clear underdrains of obstructions or clogging material.
- Inspect the energy dissipater at the inlet to ensure it is functioning adequately, and that there is no scour of the surface mulch. Remove any accumulation of sediment.

- Inspect mulch and, if needed, install new wood or rock mulch depending on site conditions. It is recommended that Biotreatment Wood Mulch<sup>53</sup> be applied once a year to maintain a 3" depth. Rock mulch can be raked up or manually collected and redistributed after maintenance is performed.

After large storm events, the system should be inspected for:

- Erosion of biotreatment soil media, loss of mulch, trash, standing water, and structural integrity of walls, flow spreaders, energy dissipaters, curb cuts, outlets and flow splitters for cracks and breaks. If using rock mulch, check for 3" of coverage.



*Figure 8-5: Flow through planter in Emeryville (Credit: EOA, Inc.)*

For more guidance on how to conduct these maintenance tasks, **see visual aids provided in Section 6.4 of the GI Design Guide**. Specifically, for bioretention areas, see detailed examples of: mulch application, hand weeding, plant coverage and health, visual safety, grass trimming, irrigation schedule and irrigation components condition, sediment load management, trash removal, and erosion control.

### **8.4.3 Tree Well Filters (Chapter 6.3) – Common Maintenance Concerns**

The following maintenance requirements are typical:

- Conduct a biannual (twice yearly) evaluation of the health of trees and any ground cover. Remove any dead, dying, or missing vegetation.
- Do not use pesticides or other chemical applications to control weeds or unwanted growth.
- Use compost and other natural soil amendments and fertilizers instead of synthetic fertilizers, especially if the system uses an underdrain.

---

<sup>53</sup> See Chapter 6 and the [Biotreatment Wood Mulch specification](http://www.flowstobay.org/newdevelopment) on the Flowstobay website: [www.flowstobay.org/newdevelopment](http://www.flowstobay.org/newdevelopment)

- Inspect mulch and, if needed, install new wood or rock mulch depending on site conditions. It is recommended that Biotreatment Wood Mulch<sup>54</sup> be applied once a year to maintain a 3" depth. Rock mulch can be raked up or manually collected and redistributed after maintenance is performed.
- Maintain vegetation and the irrigation system. Prune and weed as needed to keep the tree well filter neat and orderly in appearance. Clean up fallen leaves or debris.
- Before the wet season begins, check that the media is at the appropriate depth. Remove any accumulations of sediment, litter, and debris. Confirm that the tree well filter is not clogging and will drain per design specifications. Till or replace the media as necessary.
- Inspect tree well filter periodically, and after storms, to ensure that it has not clogged.
- Periodically inspect the overflow pipe to make sure that it can safely convey excess flows to a storm drain. Repair or replace any damaged or disconnected piping.

For more guidance on how to conduct these maintenance tasks, **see visual aids provided in Section 6.3 and 6.4 of the GI Design Guide**. Specifically for tree filters, see detailed examples of: mulch application, hand weeding, tree health and pruning, irrigation schedule and irrigation components condition, sediment load management, trash removal, and erosion control.



*Figure 8-6: Tree well filter  
(Source: University of New Hampshire, 2012)*

### **8.4.4 Infiltration Trenches (Chapter 6.4) – Common Maintenance Concerns**

The primary maintenance objective is to prevent clogging, which may lead to trench failure. Typical inspection and maintenance tasks are as follows:

---

<sup>54</sup> See Chapter 6 and the [Biotreatment Wood Mulch specification](http://www.flowstobay.org/newdevelopment) on the Flowstobay website: [www.flowstobay.org/newdevelopment](http://www.flowstobay.org/newdevelopment)

## 8.4 Specific Maintenance Activities by Treatment Measure

- Inspect infiltration trench after large storm events and remove any accumulated debris or material.
- Check the observation well 2 to 3 days after storms to confirm drainage.
- Repair any erosion at inflow or overflow structures.
- Conduct a thorough inspection annually, including monitoring of the observation well to confirm that the trench is draining within the specified time.
- If inspection indicates that the trench is partially or completely clogged, it should be restored to its design condition.
- Mow and trim vegetation around the trench as needed to maintain a neat and orderly appearance.
- Do not use pesticides or other chemical applications to control weeds or unwanted growth of vegetation near the trench.
- Routinely remove trash, grass clippings and other debris along the trench perimeter and dispose of these materials properly. Trees or other large vegetation should be prevented from growing adjacent to the trench to prevent damage to the trench.



*Figure 8-7: Infiltration Trench (Credit: CASQA)*

For more guidance on how to conduct these maintenance tasks, **see visual aids provided in Section 6.4 of the GI Design Guide.**

### 8.4.5 Extended Detention Basins (Chapter 6.5) – Common Maintenance Concerns

Primary maintenance activities include vegetation management and sediment removal, although mosquito control is a concern in extended detention basins that are designed to include pools of standing water. The typical maintenance requirements include:

- Harvest vegetation annually, during the summer.
- Trim vegetation at the beginning and end of the wet season and inspect monthly to prevent establishment of woody vegetation and for aesthetic and mosquito control reasons.
- Do not use pesticides or other chemical applications to control weeds or unwanted growth.
- Conduct a biannual (twice yearly) evaluation of the health of the vegetation and remove and replace any dead or dying plants.
- Conduct semi-annual inspection as follows:
  - Inspect the outlet, embankments, dikes, berms, and side slopes for structural integrity and signs of erosion.
  - Examine outlets and overflow structures and remove any trash or debris plugging the outlets. Identify and minimize any sources of sediment and debris. Check rocks or other erosion control and replace, if necessary.
  - Check inlets to make sure piping is intact and not plugged. Remove accumulated sediment and debris near the inlet.
  - Inspect for standing water and correct any problems that prevent the extended detention basin from draining as designed.
  - If mosquito larvae are observed, contact the San Mateo County Mosquito and Vector Control District through their on-line service request at [www.smcmvcd.org/online-service-request](http://www.smcmvcd.org/online-service-request) or call the District at (650) 344-8592.
  - Check for slope stability and the presence of rodent burrows. Fill in any holes detected in the side slopes.
  - Confirm that any fences around the facility are secure.
- Maintenance activities at the bottom of the basin should not be performed with heavy equipment, which would compact the soil and limit infiltration.
- Remove sediment from the forebay as needed.
- Remove accumulated sediment within the basin area and regrade about every 10 years or when the accumulated sediment volume exceeds 10 percent of the basin volume.



*Figure 8-8: Extended Detention Basin, Palo Alto*

- Remove accumulated trash and debris from the extended detention basin at the middle and end of the wet season (January and April), or as needed.

### 8.4.6 Pervious Pavement (Chapters 6.6 and 6.7) – Common Maintenance Concerns

Types of pervious pavement include pervious concrete, porous asphalt, pervious pavers, permeable pavers, and reinforced grid paving. All pervious pavement can become clogged with sediment over time if routine maintenance is not performed. Sources of sediment include vehicles and eroding soil, leaves, and mulch from adjacent landscaped areas. Regular surface cleaning will help maintain a high surface permeability and keep out vegetation.

#### Routine maintenance (two to four times annually):

- Prevent soil from washing or blowing onto the pavement. Do not store sand, soil, mulch or other landscaping materials on pervious pavement surfaces.
- Conduct preventative surface cleaning, using commercially available regenerative air or vacuum sweepers, to remove sediment and debris.

#### Inspection (two to four times annually):

- Check for sediment and debris accumulation on pervious pavement.
- Check for standing water on the pavement surface within 30 minutes after a storm event if possible. Standing water indicates that restorative cleaning may be required.
- Inspect pervious pavement for any signs of pavement failure.
- Inspect underdrain outlets and cleanouts annually, preferably before the wet season. Remove accumulated trash/debris.



Figure 8-9: Permeable pavers in Berkeley (Credit: EOA Inc.)

### As needed maintenance:

- Remove weeds from pervious pavement as needed. Do not use pesticides or other chemical applications to control weeds or unwanted growth near pavement or between pavers. Vegetation in reinforced grid paving (such as turf block) should be mowed as needed.
- Repair any surface deformations or broken pavers. Replace missing joint filler in permeable pavers.
- If routine cleaning does not maintain the permeability, then restorative surface cleaning with a vacuum sweeper and/or reconstruction of part of the pervious surface may be required. Adjust the vacuum sweeper suction to a level that does not remove portions of the pervious pavement base layer or joint filler.
- Power washing with simultaneous vacuuming also can be used to restore surface permeability to highly clogged areas of pervious concrete, porous asphalt, pervious pavers or permeable pavers, but is not recommended for reinforced grid paving.
- Replenish aggregate in permeable paver joints or grids as needed after restorative surface cleaning.

For more guidance on how to conduct these maintenance tasks, **see Section 6.2 of the GI Design Guide and Section 6.4 for the visual aids provided.** Specifically for pervious pavement, see detailed examples of: sediment load management, trash removal, and pervious pavement sweeping.

### ***8.4.7 Rainwater Harvesting (Chapter 6.9) – Common Maintenance Concerns***

- Conduct annual inspections of all components, including pumps, valves, tanks, and backflow prevention systems, and verify operation.
- Inspect and clean filters and screens every three months and replace when necessary.
- Inspect and verify that disinfection, filters, and other water quality treatment devices are operational, in accordance with manufacturer’s recommendations or local jurisdiction requirements.
- If rainwater is provided for indoor use, conduct annual water quality testing per the requirements of the local jurisdiction.
- Inspect and clear debris from rainwater gutters, roof surfaces, downspouts, roof washers, and first-flush devices every six months, or as needed, to prevent clogging. Remove tree branches and vegetation overhanging roof surfaces to reduce amount of debris.
- Maintenance requirements specific to cisterns:
  - Flush cisterns annually to remove sediment. Flushed water should drain to landscaping or to the sanitary sewer.
  - For buried structures, vacuum removal of sediment is required.
- Maintenance requirements specific to rain barrels:
  - Regularly inspect the gutters and gutter guards, downspouts, spigots, and rain barrels, and clean or replace parts as needed.

- Inspect screens and seals prior to the wet season to make sure debris is not collecting on the surface and that there are not holes allowing mosquitoes to enter the rain barrel. Inspect screens more frequently if there are trees that drop debris on the roof.



*Figure 8-10: Rainwater Harvesting Cistern in Oakland at Mills College  
(Credit EOA, Inc.)*

- Clean the inside of the rain barrel once a year (preferably at the end of the dry season when the rain barrel has been fully drained) to prevent buildup of debris. If debris cannot be removed by rinsing, use vinegar or another non-toxic cleaner. Use a large scrub brush on a long stick, and avoid actually entering the rain barrel. Drain washwater to landscaping.

### **8.4.8 Media Filters (Chapter 6.10) – Common Maintenance Concerns**

Clogging is the primary maintenance concern for media filters, although mosquito control is also an issue. Typical maintenance requirements are as follows:

- During the wet season, inspect periodically for standing water, sediment, trash and debris, and to identify potential problems.
- If mosquito larvae are observed, contact the San Mateo County Mosquito and Vector Control District through their on-line service request at [www.smcmvcd.org/online-service-request](http://www.smcmvcd.org/online-service-request) or call the District at (650) 344-8592
- Remove accumulated trash and debris during routine inspections.
- Replace filter media as needed.
- Complete any other maintenance activities recommended by the manufacturer.



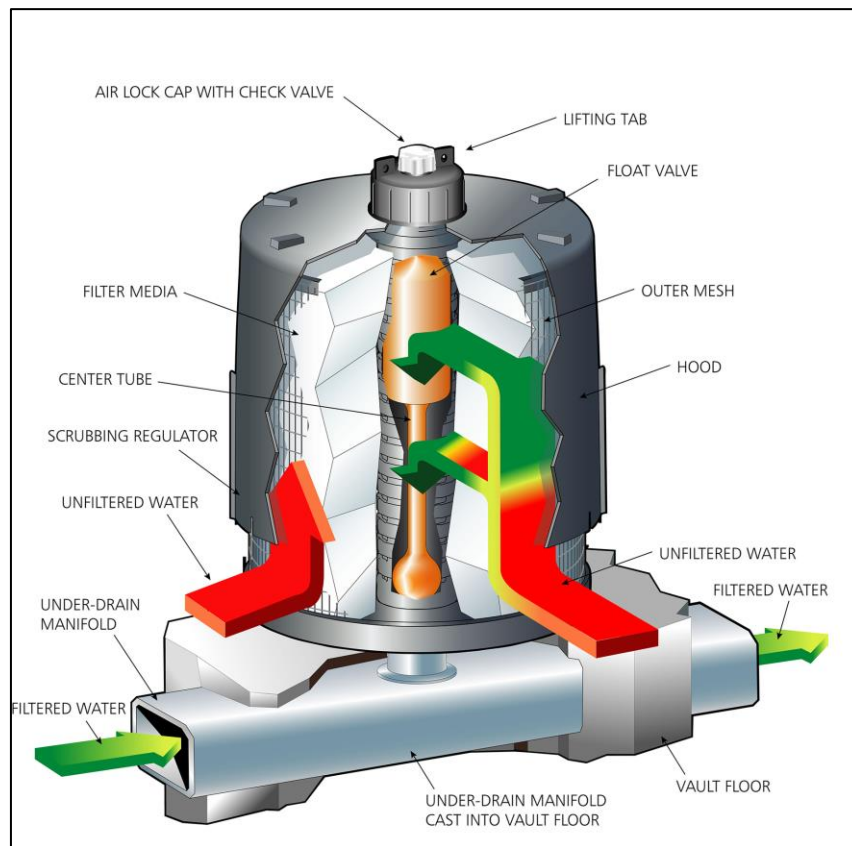


Figure 8-11: Example of a media filter cartridge (Type C, as described in Section 6.10), which is typically used as part of an array (Credit: [www.stormwaterinc.com](http://www.stormwaterinc.com)). This drawing is shown for general information only; its use is not an endorsement of any proprietary product.

# Chapter 9: Alternative Compliance

9.1	<i>What is Alternative Compliance?</i> .....	9-2
9.2	<i>Categories of Alternative Compliance for On-site Portions of Regulated Projects</i> .....	9-3
9.2.1	Option 1: LID Treatment at an Off-Site Location .....	9-3
9.2.2	Option 2: Payment of In-Lieu Fees .....	9-3
9.2.3	Option 3: On-site Alternative Compliance.....	9-4
9.3	<i>Offsite or Regional Project Completion Deadlines</i> .....	9-4
9.3.1	Timeline for Construction of Off-site Project .....	9-4
9.3.2	Timeline for Construction of a Regional Project.....	9-4
9.4	<i>Alternative Compliance Options for Other Areas Requiring Stormwater Management</i> .....	9-4
9.4.1	Areas Fronting Regulated Projects (e.g., in the Public Right of Way) that are Required to be Managed by the MRP .....	9-4
9.4.2	O&M of Alternative Compliance Areas Fronting Regulated Projects in the Public Right of Way .....	9-6
9.5	<i>Alternative Compliance Case Study</i> .....	9-6

## 9.1 What is Alternative Compliance?

Provision C.3.e of the Municipal Regional Stormwater Permit (MRP) allows municipalities to grant “alternative compliance” to new development or redevelopment projects in lieu of requiring full onsite treatment of the Provision C.3.d amount of stormwater runoff and pollutant loads with low-impact development (LID) measures. **Projects that receive alternative compliance must still provide LID treatment in full**, but the treatment does not have to take place onsite. There are no special eligibility criteria for using alternative compliance in the MRP. If the project is required to provide LID treatment, then alternative compliance may be used to meet these requirements. There is no MRP requirement to make LID impracticability or infeasibility findings in order to use alternative compliance. The MRP offers two options for using alternative compliance, described in Section 9.2 and sets deadlines for constructing offsite alternative compliance projects (Section 9.3).

### Definitions

**Joint Treatment Facility:** A stormwater treatment facility built to treat the *combined runoff from two or more regulated projects* at a nearby, offsite location that discharges into the same watershed as the regulated project.

**Regional Project:** A regional or municipal stormwater treatment facility that *treats runoff from a region of the watershed* that discharges into the same watershed as the Regulated Project.

**Offsite Equivalent Treatment Project:** An offsite equivalent treatment project provides off-site LID treatment for a surface area or volume and pollutant loading of storm water runoff, equivalent to that of the proposed new development or redevelopment project for which alternative compliance is sought. Examples of acceptable equivalent treatment projects include the installation of hydraulically-sized LID treatment measures in a nearby parking lot, development project, or street where hydraulically-sized LID treatment measures were not previously installed.

**On-site:** The portion of a construction or development project that **is on** the parcel or property that is the primary development location. For private development projects this is the area of the project’s scope that is on the parcel(s) that are privately owned (e.g., the parcel where a new privately-owned building is being built). For public projects this is defined as the area(s) of a public project that are part of the scope of the municipal project (e.g., the curb-to-curb roadway section of a road reconstruction project.)

**Off-site:** The area adjacent to a construction or development project that **is not on** the parcel or property that is the primary development location. For private development projects this is typically the frontage area that is in the public right of way and not on the private property (e.g., the sidewalk, planter strip and possibly sections of the roadway). For public projects the off-site areas are adjacent to areas that are within the scope of the project (e.g., sidewalks, that are not part of scope of the municipality’s project).

**Watershed:** For Alternative Compliance projects within San Mateo County, there are two watersheds: the San Francisco Bay and the Pacific Ocean. Alternative Compliance areas must drain to the same watershed as the Regulated Project (e.g., an Alternative Compliance area for a Regulated Project in Half Moon Bay must also be built in a location that drains to the Pacific Ocean).

## 9.2 Categories of Alternative Compliance for On-site Portions of Regulated Projects

A Regulated Project may use any of the alternative compliance options listed below to provide treatment for the on-site impervious surfaces that will not be treated on-site. Sections 9.2.1 and 9.2.2 describe the options in Provision C.3.e of the permit, while Section 9.2.3 provides an additional option that is not explicitly described in the MRP, but is nonetheless generally considered an option.

### 9.2.1 Option 1: LID Treatment at an Off-Site Location

Projects may use alternative compliance to treat the required amount of stormwater runoff off-site using LID in three different ways:

- Off-site at a Joint Treatment Facility (all or a portion);
- Off-site at a Regional Project (all or a portion); or
- Off-site at another location (all or a portion).

The off-site treatment must be located ***within the same watershed as the development project using alternative compliance***. Offsite LID treatment measures must provide an equivalent or greater quantity of hydraulically-sized treatment of both stormwater runoff and pollutant loads and ***achieve a net environmental benefit***. The LID measures must follow the same basic design requirements used for on-site treatment and treat the C.3.d amount of runoff.

### 9.2.2 Option 2: Payment of In-Lieu Fees

Projects may treat a portion of the required amount of stormwater runoff using LID on-site or offsite at a joint treatment facility and ***pay equivalent in-lieu fees to treat the remaining amount*** of stormwater runoff with LID treatment measures at a Regional Project.

#### In-Lieu Fees

In-lieu fees provide the monetary amount necessary to treat an equivalent quantity of stormwater runoff and pollutant loading with hydraulically-sized LID treatment measures at a Regional Project ***and*** the monetary amount necessary to share a proportionate amount of the operation and maintenance costs of the Regional Project. Additionally, there is nothing in the MRP that disallows the use of in-lieu fees for payment of O&M costs to be used in combination with ***any*** of the alternative compliance types of projects discussed in this Chapter.

#### Regional Project

A Regional Project is a regional or municipal stormwater treatment facility located in the same watershed as the project seeking alternative compliance. While not explicitly discussed in the MRP, there does not appear to be any reason why a municipality cannot construct a Regional Project and then collect in-lieu fees from regulated projects afterwards to recover the costs for the design, construction, operation and maintenance of that Regional Project.

### **9.2.3 Option 3: On-site Alternative Compliance**

While not explicitly discussed in the MRP, it is generally understood that a third type of alternative compliance is allowed. This type of alternative compliance entails a regulated project that is redeveloping a portion of the site and is therefore only required to treat the runoff from that portion of the site (in other words, the 50% rule has not been triggered which would have required treatment of the whole site). If the project cannot treat a portion of the runoff on the newly redeveloped section of the site with LID, then an equivalent section of the un-redeveloped portion of the site may be treated with LID treatment measures in exchange. An example of this situation is given below:

*A property owner with a 3-acre site is building a half-acre expansion of an existing one-acre impervious parking lot on the site with new impervious pavement. As the new half-acre section of the parking lot is less than 50% of the size of the existing parcel, only the new section of the parking lot is required to install LID treatment. However, the new parking lot section does not have space for any treatment. In exchange, the property owner retrofits an area slightly larger than a half-acre of the original parking lot with C.3.d-sized LID treatment, providing a net water quality benefit for the project and compliance with the MRP.*

## **9.3 Offsite or Regional Project Completion Deadlines**

### **9.3.1 Timeline for Construction of Off-site Project**

Construction of the on-site, off-site or joint LID treatment project must be completed within three years after the end of the construction of the subject project.

### **9.3.2 Timeline for Construction of a Regional Project**

Regional Projects must be completed within three years of the subject project. This can be extended to five years only with prior Regional Water Board Executive Officer approval. In order for the Executive Officer to grant the extension to five years, the applicant must have demonstrated good-faith efforts to implement the Regional Project by applying for the necessary permits and having the necessary funds encumbered for project completion.

## **9.4 Alternative Compliance Options for Other Areas Requiring Stormwater Management**

### **9.4.1 Areas Fronting Regulated Projects (e.g., in the Public Right of Way) that are Required to be Managed by the MRP**

As of July 1, 2023, MRP 3.0 requires stormwater management of runoff from created and/or replaced impervious surfaces that are constructed in the public right of way fronting regulated parcel-based projects and are part of the regulated project scope of work. In some instances, there may be constraints (e.g., utility conflicts) in the public right of way that can make construction of treatment measures in the public

right of way difficult. In these circumstances the permitting agency (municipality) may decide to allow the regulated project applicant (e.g., private developer) to use alternative compliance (AC) options to comply with the MRP. In this situation, some issues for the municipality to consider are:

1. Determine if the regulated project applicant's findings on constraints are significant enough to prevent them from managing the stormwater in the frontage area.
2. Before the alternative compliance option is granted, the project applicant should create drainage management areas specific to any and all frontage areas to calculate how many square feet of impervious area will need to be managed through the AC process.
3. Consider if the AC areas that the applicant is proposing to manage are going to be redeveloped any time soon. If so, another area for AC may be considered to avoid triggering AC for the future regulated project.
4. Determine if the AC areas that the applicant is proposing to manage are going to leverage multiple benefits such as bike and/or pedestrian safety improvements or increased urban forestry canopy (if using tree well filters). The municipality may want to balance several factors to choose where to require the AC to occur. An interdepartmental staff meeting (e.g., planning, public works, transportation, urban forestry, etc.) may be useful to determine areas for AC.

### 9.4.2 O&M of Alternative Compliance Areas Fronting Regulated Projects in the Public Right of Way

It is recommended that the municipality carefully consider several issues regarding the operation and maintenance of treatment measures located in the frontage areas in the public right of way of regulated projects. The considerations can become more complex when alternative compliance (AC) is used by the applicant. Some of the issues to consider are:

1. Determine whether the applicant (e.g., the developer/property owner) or the City will be operating and maintaining the AC area(s) in perpetuity:
  - a. The municipality may require the applicant to construct, operate and maintain the treatment measures in the AC areas; or,
  - b. The municipality may require the applicant to construct the treatment measures in the AC areas and then the municipality can take over maintenance of the treatment measures. The applicant should then pay the municipality an AC in-lieu maintenance fee equivalent to 30-50 years of maintenance costs and that would be documented in the O&M Agreement.
2. If the applicant maintains the treatment measures in the AC Areas:
  - a. It is recommended that the AC areas be located as close as possible to the regulated project as possible for ease of maintenance and clarity in the O&M agreement.
  - b. It is recommended that the municipality require the applicant's treatment measure maintenance contractor to have certifications or credentials establishing that they have the appropriate training and experience to operate and maintain the treatment measures.
3. If the municipality maintains the treatment measures in the AC Areas:
  - a. It is recommended that the applicant construct the treatment measures near other areas that the municipality is maintaining for easier addition to maintenance contracts or municipal staff responsibilities. Also consider the access, difficulty, and expense of operating and maintaining the AC areas over the long term and the burden placed on the municipality. Determine if there are other AC areas where O&M would be less difficult and/or less expensive.
4. The O&M Agreement for the regulated project should document the AC areas in detail in addition to the on-site treatment measures that normally would be documented in an O&M agreement.

## 9.5 Alternative Compliance Case Study

### City of Emeryville

In July 2017, the City Council of the City of Emeryville approved the use of an alternative compliance option for a portion of a private property owner's 14.5-acre mixed use redevelopment project building 674 multi-family residential units, 180,000 square feet of retail, and 120,000 square feet of office space. The majority of the project uses LID to treat on-site stormwater runoff. However, because one four-acre parcel of the site contains several existing buildings and pavement that have been retained and required treatment, the property owner chose to propose to the City the use of an alternative compliance option in MRP 2.0. Several

challenges to constructing LID stormwater treatment measures on this parcel were identified early on in the project design including contaminated soil, a high seasonal groundwater table, conflicts with existing and planned utilities, clayey soils, tidal flows, and limited space.

The City used an “Off-site Stormwater Improvement Agreement” (Improvement Agreement) to detail the requirements of the property owner, who constructed and retrofitted approximately 6,300 square feet of new and existing GI measures (bioretention facilities) in four locations of the City’s public right-of-way and in a City park to treat runoff from an amount of impervious surface greater than what would have been treated on-site providing a net water quality benefit. The model for the Improvement Agreement was the City’s standard improvement agreement that all development projects use for public right-of-way work that is required as a condition of approval. The key purposes of the agreement are to:

- Describe the conditions that led to the approval of off-site stormwater treatment;
- Set forth a process and timeframe for approval of plans and construction; and
- Describe maintenance responsibility and a calculation of cost for maintenance.

The off-site locations for GI were chosen through a consensus-based decision process that provides benefits to both the City and the property owner, including the following:

- Net water quality benefit compared with on-site provision of treatment measures through increases in pollutant of concern type and load reductions and increases of square footage of catchment and treatment area using the C.3.d sizing criteria;
- Increased cyclist and pedestrian safety through the use of stormwater curb extensions as traffic calming measures at intersections and in mid-block areas;
- Replacement of trees in poor health with new trees and improved planting conditions;
- Replacement of turf and other conventional landscapes with new sustainable, Bay-Friendly landscaping with reduced O&M costs, pesticides use, air emissions and carbon footprint;
- Reductions in pollutant (e.g., PCBs, mercury and trash) discharges to the Bay by treating runoff from a larger variety of land uses and roadways as opposed to just roof tops on-site;
- Lower net cost for the property owner; and
- Progress towards meeting MRP 2.0 GI implementation long-term goals.

The developer agreed to bear the costs of design, permitting, construction, and inspection of the improvements as well as 30 years of post-project O&M of the systems. The City chose to require an in-lieu fee for the O&M costs to be paid by the developer in a lump sum after a majority of the installations have been accepted as complete by the City as detailed in the Improvement Agreement.



## 9.5 Alternative Compliance Case Study

In 2018, the developer contracted with design and construction firms and paid the City-required plan check fees, insurance and permits necessary to build the improvements. The system designs were approved by the City in August of 2018. Construction began in December of 2018 and the work is now complete. The City is inspecting the improvements via the normal process for any work in the public right-of-way or on public property and after construction is accepted will be assuming responsibility for the maintenance of the new treatment areas using the funds paid by the developer. The O&M agreement for the on-site LID measures of the parcel at the development project will reference the Improvement Agreement and the approval by the City of the alternative compliance option to document in perpetuity the compliance of the project with the MRP and inform future property owners and the City of the agreement conditions and process that was used. Before and after photos of one of the five GI locations are shown in Figures 9-1 and 9-2 below with the tributary area shown in Figure 9-3:



Figure 9-1: Before: Vehicle parking and high-water-using turf landscape strip with failing trees on east side of street. (Both, Credit: EOA, Inc.)



Figure 9-2: After: Parking moved to the west side of the street and the landscape strip widened into a Bay-Friendly bioretention area with new trees.

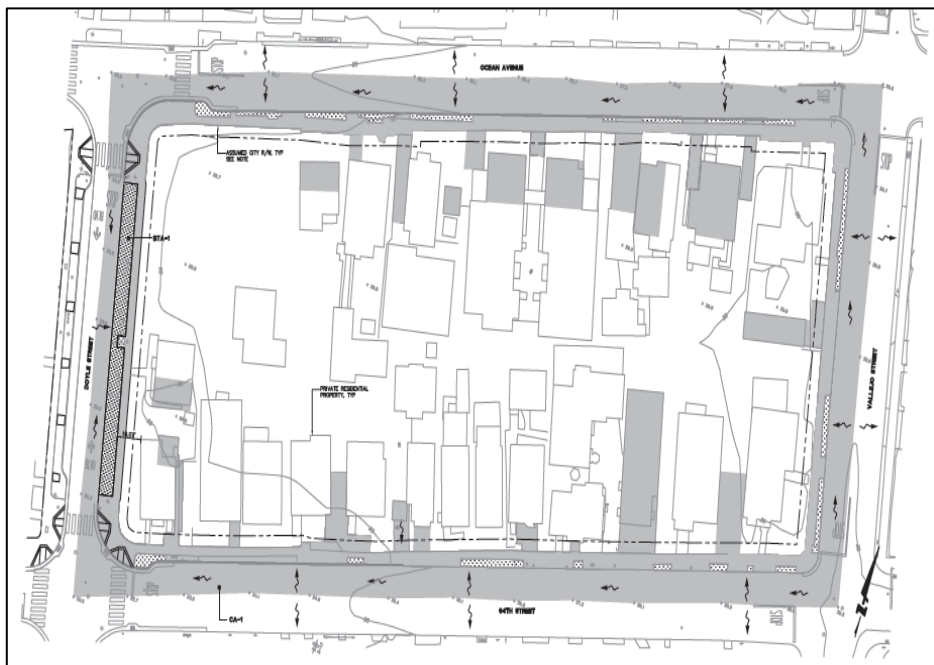


Figure 9-3: Map of the residential streets, parcels and tributary area (shown in gray shading) of the new treatment system shown on the left (west) side of map in the black outlined strip with flow directions. (Courtesy: BKF Engineers and City of Emeryville.)

# Appendix A: Plant List and Planting Guidance for Landscape-Based Stormwater Measures

<i>Introduction</i> .....	A-2
<i>A.1 General Recommendations</i> .....	A-2
Site-Specific Factors .....	A-3
Supplemental Watering Needs.....	A-3
<i>A.2 Plants for Stormwater Measures</i> .....	A-3
<i>A.3 Planting Specifications</i> .....	A-11
Propagation and Planting Methods.....	A-11
Water Level Management and Irrigation for Plant Establishment .....	A-13
<i>A.4 Planting Tips for Single-Family Homes</i> .....	A-14
<i>A.5 Nursery Sources for Native Plants</i> .....	A-15
<i>A.6 Trees, Rootable Soil Volume and Suspended Pavement Systems</i> .....	A-17
<i>A.7 References</i> .....	A-21

## Introduction

The purpose of this appendix is to provide guidance on the planting techniques and selection of appropriate plant materials for the stormwater measures described in this handbook.

The list of plants provided in this appendix is not prescriptive but should serve as a guide. Other appropriate plant species may be selected by a landscape architect or landscape designer with approval by the permitting jurisdiction. In selecting plant materials, it is important to consider factors that influence plant establishment and success, such as microclimate, type of soil, water availability, proximity to saltwater and exposure to sun. Numerous resources are available to assist in selecting appropriate plant species in San Mateo County, including Sunset's *Western Garden Book* and the East Bay Municipal Utility District's *Plants and Landscapes for Summer-Dry Climates of the San Francisco Bay Region*.

In addition, the function of the individual stormwater measure should be carefully considered when selecting plant materials. Factors to be considered include inundation period, expected flow of water, and access and maintenance requirements.

### Key Point

The list of plants provided in this appendix is not prescriptive but should **serve as a guide**. In selecting plant materials, it is important to consider factors that influence plant establishment and success, such as microclimate, type of soil, water availability, proximity to saltwater and exposure to sun.

## A.1 General Recommendations

- **Avoid the use of invasive species.** In selecting plants for stormwater measures, the use of invasive species should be avoided. A complete list of invasive plants can be found at [www.cal-ipc.org](http://www.cal-ipc.org), the California Invasive Plant Council's Invasive Plant Inventory.
- **Minimize or eliminate the use of irrigated turf.** Effort should be made to minimize the use of irrigated turf, which has higher maintenance requirements and greater potential for polluted runoff.
- **Select California natives and/or drought tolerant plants.** Planting appropriate, drought tolerant California natives or Mediterranean-climate plants reduces water consumption for irrigation, and reduces mowing, fertilizing, and spraying. For the purposes of the plant list on the following pages, "drought tolerant" refers to plants that meet any of the following criteria:
  - Are identified as drought tolerant in *California Native Plants for the Garden* (Borstein, et al.).
  - Are identified as requiring no summer water; or occasional or infrequent irrigation in Borstein, et al., or *Plants and Landscapes for Summer Dry Climates* (EBMUD).
  - Are identified as requiring little or no water in the *Sunset Western Garden Book*.
  - Are identified as requiring "low" or "very low" irrigation in the *Guide to Estimating Irrigation Water Needs of Landscape Plantings in California* (University of California Cooperative Extension) or via the Water Use Classifications of Landscape Species ([WUCOLS](#)) database.

- Selection of plants not listed in any of the above references<sup>1</sup> will should be based upon the design professional's successful experience with species on previous projects under similar horticultural conditions. Design professionals should include plant locations (basins, banks, upland, etc.) within the planting legend for reviewer clarity.

### *Site-Specific Factors*

Given San Mateo County spans several Sunset climate zones, with variable humidity, heat, frost, and wind factors, as well as varying soil characteristics, plants should be selected with an understanding of specific climate and microclimate conditions and grouped in appropriate hydrozones.

### *Supplemental Watering Needs*

Many plants listed as drought tolerant per the above references may require more supplemental watering in fast-draining, engineered soils. Water use calculations should consider the specified biotreatment soil media (see Appendix C), which will remain drier than native amended soils and has reduced water holding capacity. Consider the addition of biochar to increase water holding capacity. One study showed that a 9% addition of biochar can double water holding capacity in soil media<sup>2</sup>.

## *A.2 Plants for Stormwater Measures*

Plants play an important role in the function of landscape-based stormwater treatment measures:

- Infiltration and evapotranspiration. Plants aid in the reduction of stormwater runoff by both increasing infiltration, and by returning water to the atmosphere through evapotranspiration.
- Pollutant trapping. Vegetation helps to prevent the resuspension of pollutants associated with sediment particles. It is essential that pollutants removed during small storms are not remobilized during large storms.
- Phytoremediation. Plants for stormwater treatment measures are important for their role in phytoremediation, the uptake of nutrients and the ability to neutralize pollutants. Forbs (herbaceous perennials) and graminoids (grasses) offer optimal opportunity for pollutant capture.
- Soil stabilization. As in any landscaped area, established plantings help control soil erosion. This is important both to keep sediment out of stormwater and to retain the surface soils, which help to remove pollutants from infiltrated runoff.
- Aesthetic benefits. Plants within or adjacent to stormwater facilities provide an aesthetic benefit.

Plants suitable for use in stormwater treatment measures are organized according to the following categories:

---

<sup>1</sup> Please note that the plants identified as drought tolerant per the references/resources above do not take the reduced water holding capacity of standard biotreatment soil media or extended periods of drought into account.

<sup>2</sup> [https://www.researchgate.net/publication/275484594\\_Impact\\_of\\_biochar\\_on\\_the\\_water\\_holding\\_capacity\\_of\\_loamy\\_sand\\_soil](https://www.researchgate.net/publication/275484594_Impact_of_biochar_on_the_water_holding_capacity_of_loamy_sand_soil)

- **Grasses** refer to those species that are monocotyledonous plants with slender-leaved herbage found in the in the Family Poaceae.
- Perennials and groundcovers are typically **herbaceous** plants with soft upper growth rather than woody growth. Some species will die back to the roots at the end of the growing season and grow again at the start of the next season.
- **Shrub** is a horticultural distinction that refers to those species of woody plants which are distinguished from trees by their multiple stems and lower height. A large number of plants can be either shrubs or trees, depending on the growing conditions they experience.
- **Tree** refers to those species of woody plants with one main trunk and a rather distinct and elevated head.

Plants suitable for use in stormwater treatment measures are listed in two ways. First, a comprehensive list of all recommended plant species is provided in Table A-1, which lists the plants in alphabetical order by Latin name, in the categories described above. Second, the columns in Table A-1 indicate stormwater treatment measures for which each plant species may be suitable.

TREES		DESCRIPTION					PLANTING & MAINTENANCE					LANDSCAPE INTEREST/USES	TREATMENT TYPES			COMMENTS
Scientific Name	Common Name	Evergreen (E) or Deciduous (D)	Height (Feet)	Spread (Feet)	Shape: Round (R), Pyramidal (P), Broad (B), Oval (O), Upright (U)	Growth Rate: Fast (F), Moderate (M), Slow (S)	Water Needs: Very Low (VL), Low (L), Moderate (M)	Solar Needs: Full-Sun (FS), Part-Shade (PS), Shade (S)	Maintenance Needs: Low (L), Moderate (M)	CA Native		Bioretention Planter	Flow-Through Planter	Tree Well Filter		
<i>Acer circinatum</i>	Vine Maple	D	15	15-20	R	f	M	PS	M	●	Understory small tree from Pacific NW, avoid direct hot sun, orange-red fall color; adaptable to clay, rocky soils; tolerates moisture, drought tolerant when established.	●	●	●	Best in Sunset Zone 17 in part sunny areas.	
<i>Acer macrophyllum</i>	Big Leaf Maple	D	40 to 80	30 to 50	B	F	M	PS	M	●	Striking fast growing native maple with bright yellow fall color.	●			Best in Sunset Zone 17 in part sunny areas.	
<i>Arbutus 'Marina'</i>	Strawberry Tree	E	20	15	R	M	L	FS to PS	M	●	Red-brown trunks and large branches of mature trees become twisted and gnarled in appearance; can be messy. Clay-tolerant; acid to neutral soil.	●	●	●		
<i>Carpinus betulus</i>	Fastigate European Hornbeam	D	30 - 40	20 - 30	U	S-M	M	FS to PS	L		Upright, dense form; long lived. Tolerates moisture in well-drained soils.	●			Best in Sunset Zone 17 in part sunny areas.	
<i>Celtis reticulata</i>	Western Hackberry	D	30-60	30-60	R	M	L	FS to PS	L	●	Spreading tree canopy. Tolerates poor soils.	●				
<i>Cercis canadensis</i>	Eastern Redbud	D	25-35	25-35	R	F	L-M	FS to PS	L		Deep pink early spring bloom; glossy, heat resistant leaves; short lived	●	●	●	Part sun in hotter microclimates	
<i>Cercis occidentalis</i>	Western Redbud	D	10-18	10-18	R	S	L	FS	M	●	Deep pink early spring bloom; Use multi-trunk where possible; short lived. Clay-tolerant.	●	●	●		
<i>Geijera parviflora</i>	Australian Willow	E	40	30	O	S	M	FS to PS	L		Low, early pruning; train prune longer due to slow growth; long lived. Clay-tolerant.	●				
<i>Ginkgo biloba 'Autumn Gold'</i>	Autumn Gold Maidenhair Tree	D	40	30	O	S	M	FS to PS	L		Low, early pruning; train prune longer due to slow growth; long lived. Clay-tolerant. Prefers moist, well-drained soils. Golden fall color.	●			Best in Sunset Zone 17 in part sunny areas.	
<i>Ginkgo biloba 'Fairmount'</i>	Fairmount Maidenhair Tree	D	50	20	P	F	M	FS to PS	L		Faster growing than other Ginkgos; erect pyramidal form; long lived. Clay-tolerant. Prefers moist, well-drained soils. Golden fall color.	●			Best in Sunset Zone 17 in part sunny areas.	
<i>Ginkgo biloba 'Fastigiata'</i>	Columnar Ginkgo	D	30-50	10-15	U	S	M	FS to PS	L		Columnar. Clay-tolerant. Prefers moist, well-drained soils. Golden fall color.	●			Best in Sunset Zone 17 in part sunny areas.	
<i>Ginkgo biloba 'Magyar'</i>	Magyar Ginkgo	D	50	15	U	M	M	FS to PS	L		Clay-tolerant. Prefers moist, well-drained soils. Golden fall color. Tol. urban conditions.	●			Best in Sunset Zone 17 in part sunny areas.	
<i>Ginkgo biloba 'Princeton Sentry'</i>	Princeton Sentry Maidenhair Tree	D	40	15	P	S	M	FS to PS	L		Erect, pyramidal form; long lived. Clay tolerant. Prefers moist, well-drained soils. Heat tolerant. Golden yellow fall color.	●			Best in Sunset Zone 17 in part sunny areas.	
<i>Koelreuteria bipinnata</i>	Chinese Flame Tree	D	30	30	R	M	M	FS	L		Summer orange, red, or salmon bloom. Clay-tolerant.	●			Best in Sunset Zone 17 in part sunny areas.	
<i>Koelreuteria paniculata 'Fastigiata'</i>	Goldenrain Tree	D	20-25	20-25	R	S	M	FS	L		Yellow bloom; upright habit. Adaptable.	●			Best in Sunset Zone 17 in part sunny areas.	
<i>Lagerstroemia indica (cultivars)</i>	Crape Myrtle	D	15-25	8 to 15	R	S	L	FS	M		Attractive peeling cinnamon bark, excellent winter feature; spec cultivars: 'Muskogee', 'Natchez', 'Osage', 'Tuscarora'. Tolerates most soils; well-drained.	●		●		

TREES		DESCRIPTION					PLANTING & MAINTENANCE					LANDSCAPE INTEREST/USES	TREATMENT TYPES			COMMENTS
Scientific Name	Common Name	Evergreen (E) or Deciduous (D)	Height (feet)	Spread (feet)	Shape: Round (R), Pyramidal (P), Broad (B), Oval (O), Upright (U)	Growth Rate: Fast (F), Moderate (M), Slow (S)	Water Needs: Very Low (VL), Low (L), Moderate (M)	Solar Needs: Full-Sun (FS), Part-Shade (PS)	Maintenance Needs: Low (L), Moderate (M)	CA Native		Bioretention Planter	Flow-Through Planter	Tree Well Filter		
<i>Laurus nobilis</i> 'Saratoga'	Saratoga Bay Laurel	E	12-40	12-40	O	S	L	FS to PS	L			●	●	●	Tolerates many soils and climate conditions. Prefers moist, fast-draining soils.	
<i>Platanus x acerifolia</i> 'Bloodgood'	Bloodgood London Plane Tree	D	70-100	60	B	M/F	L/M	FS	M			●			Withstands high pH, and pollution and grime of cities. Prefers deep, rich, moist, well-drained soils.	
<i>Platanus x acerifolia</i> 'Liberty'	Liberty London Plane Tree	D	70-100	70	B	M/F	L-M	FS	M			●			Allergy concern; long lived; mildew resistant. Tolerates most soils.	
<i>Platanus x acerifolia</i> 'Yarwood'	Yarwood London Plane Tree	D	40-80	30-40	B	M/F	L-M	FS	M			●			Allergy concern; long lived; mildew resistant; 'Yarwood' foliage holds up better than most plane trees in late summer; yellow fall color. Tolerates most soils.	
<i>Platanus x acerifolia</i> 'Columbia'	Columbia London Plane Tree	D	45	40		M-F	L-M	FS	M			●			Allergy concern; long lived. Tolerates most soils.	
<i>Prunus ilicifolia</i>	Holley leaf Cherry	E	15	15	O	M	L	FS	L	●		●	●		Skinny branches with large leaves and cherry looking fruit; can be trained into a small tree. Adaptable to most soils.	
<i>Prunus ilicifolia</i> spp. <i>Lyonii</i>	Catalina Cherry Laurel	E	10	15	O	M	L	FS	L	●		●	●		Shiny green leaves with small white flowers. Adaptable to most soils.	
<i>Quercus agrifolia</i>	Coast Live Oak	E	20-70	70	O	M	VL	FS	L	●					Long-lived; attractive bark; attracts birds and butterflies; deer resistant; drought resilient. Prefers a deep loam. Use only where sufficient room for roots.	
<i>Quercus coccinea</i>	Scarlet Oak	D	70-80	40-50	R	M	L/M	FS	L			●			Foliage is a glossy green in summer turning to scarlet in fall.	
<i>Quercus ilex</i>	Holly Oak	E	30-60	30-60	R	S	L	FS	L			●			Tolerates water. Adaptable.	
<i>Quercus suber</i>	Cork Oak	E	40-70	35-40	R	M	L	FS	L			●			High VOC absorption and CO2 sequestration; long lived; ornamental cork bark. Acidic, dry to medium, well-drained loams.	
<i>Quercus wislizenii</i>	Interior Live Oak	E	25-40	25-40	O	F	VL	FS	L	●					Attractive bark; attractive birds and butterflies; deer resistant; very tough, adaptable tree. Dry, well-drained, loams, clay and gravelly loams.	
<i>Robina x ambigua</i> 'Purple Robe'	Purple Robe Locust	D	30-35	20-25	O	F	L	FS	M			●			Purplish bronze new foliage, showy violet purple flowers. Tolerate poor soils, heat, low water when established.	
<i>Tristania laurina</i> 'Elegant'	Elegant Water Gum	E	45	35	O	M	M	FS to PS	M			●		●	Profuse fragrant yellow flowers April-June. Tolerates damp well-drained soils, drought tolerant, cold tolerant to 28 degrees.	

**Notes:**

Plant selection shall be based upon site-specific conditions.

Consider subsurface infrastructure and provide sufficient growth for root area for larger trees.

Plants requiring moderate water should be planted in part sun and avoid late afternoon sun exposure on the root crowns.

SHRUBS		DESCRIPTION						PLANTING & MAINTENANCE				LANDSCAPE INTEREST/USES	PLANTING ZONES			TREATMENT TYPES			COMMENTS
Scientific Name	Common Name	Flower Color	Height (feet)	Spread (feet)	Shape: Mounding (M), Spreading (S), Upright (U), Round (R)	Growth Rate: Fast (F), Moderate (M), Slow (S)	Water Needs: Very Low (VL), Low (L), Moderate (M)	Solar Needs: Full-Sun (FS), Part-Shade (PS), Shade (S)	Maintenance Needs	CA Native		Basin	Banks	Upland	Bioretention	Flow-Through Planter	Tree Well Filter		
<i>Arctostaphylos densiflora</i> 'McMinn'	Mazanita 'McMinn'	white	5-6	7	M	M	L	FS to PS	L	●	Fine textured bright green foliage and red bark. Well-drained soils.	●	●	●	●				
<i>Arctostaphylos hookeri</i>	Hooker's Manzanita	white	2-8	3-12	M	M	L	FS to PS	L	●	Fine textured bright green foliage and red bark. Well-drained soils.	●	●	●	●		Will not tolerate wet roots		
<i>Callistemon viminalis</i> 'Little John'	Dwarf Bottlebrush	blood red	3-4	4-8	R	M	L/M	FS	L		Can be pruned up to small trees; heat tolerant. Clay tolerant.	●	●	●	●				
<i>Cistus</i> spp.	Rockrose	varies	varies 3-5 x 3-5		R	L	L	FS	M		neat, compact shrub with showy white, pink or rose-purple blooms. Adaptable.	●	●	●	●		Sensitive to excess water		
<i>Cotinus coggygria</i>	Smoke Tree	purple	12-15	up to 25	U	M	L	FS	L		Deciduous small tree/large shrub; flowers form smoke-like look around the plant; slow growing. Well-drained soils. Cold and heat tolerant.	●	●	●	●				
<i>Garrya elliptica</i>	Silk Tassel	white	10-20	10-20	R	M	L	FS to PS	L	●	Interesting flowers hang in tassels; large shrub/small tree. Well-drained soil.	●	●	●	●				
<i>Grevillea</i> spp.	Grevillea	varies				M	L	FS to PS	L		Very heat tolerant; attracts hummingbirds. Tolerant of poor soils.	●	●	●	●		Does not tolerate wet roots		
<i>Heteromeles arbutifolia</i>	Toyon	white	6-15	15-20	R	F	VL	FS to PS	M	●	Large shrub/small tree; red berries; green leaves with white flowers; takes pruning well, but flowers only on second year growth. Adaptable.	●	●	●	●				
<i>Mahonia aquifolium</i> 'Compacta'	Oregon Grape	yellow	1.5-2	3-4	S	S	L	PS	L	●	Yellow flowers in spring. Berries attract birds. Well-drained soil.	●	●	●	●				
<i>Mahonia aquifolium</i> var. <i>repens</i>	Creeping Barberry	yellow	2-3	3-4	S	S	L	PS	L	●	Yellow flowers in spring. Berries attract birds. Well-drained soil.	●	●	●	●				
<i>Mahonia nevinii</i>	Nevin Mahonia	yellow	6-10	6-12	U	M	L	PS	L	●	Rigid branches covered with gray-blue foliage. Adaptable; tolerates clay and alkaline	●	●	●	●				
<i>Mahonia pinnata</i>	California Holly Grape	yellow	4-5	4-5	U	M	L	PS	L	●	Reddish orange new growth.	●	●	●	●				
<i>Nerium oleander</i>	Oleander	red/ pink/ white	varies		R	M	L	FS	L		Very heat tolerant. Poisonous: eating flowers or chewing leaves or stems.		●			●	Size varies with varieties; Standard form for tree well filters. Can develop mildew in Zone 17 - prefers moisture only at root zone.		
<i>Photinia x fraseri</i>	Fraser Photinia	white	8-12	8-10	R	F	M	FS	L								Standard form for tree well filters; bright red-bronze spring foliage		
<i>Pittosporum tenuifolium</i>	Tawhiwhi	purple	15-25	10-15	U	F	M	FS - PS	L								Standard form for tree well filters; bright red-bronze spring foliage		
<i>Rhamnus californica</i> 'Little Sur'	Little Sur Coffeeberry	inconspicuous	3-4	3-4	R	M	L/M	FS-PS	M	●	Grey-green leaves, red bark, and showy berries in fall. Adaptable.		●	●	●		Partial shade inland		
<i>Ribes sanguineum</i> (incl cultivars)	Red-Flowering Currant	pink	6	6	U	F	L	PS	M	●	Red-pink showy flower clusters. Adaptable.	●	●	●	●				
<i>Symphoricarpos albus</i>	Snowberry	white	6	8	S	M	L/M	PS	M	●	Large white berries in the fall; berries are not edible. Adaptable.	●	●	●	●		Best with regular moisture		

**Notes:**

Plant selection shall be based upon site-specific conditions.  
Taller shrubs and perennials with more substantial roots systems can be grown on green roofs with 18" growing medium.  
Plants requiring moderate water should be planted in part sun and avoid late afternoon sun exposure on the root crowns.  
Trees/Tall shrubs planted in tree well filters shall provide sufficient vertical clearance for the location.



GRASSES		DESCRIPTION						PLANTING & MAINTENANCE				LANDSCAPE INTEREST/USES	PLANTING ZONES			TREATMENT TYPES			COMMENTS
Scientific Name	Common Name	Flower Color	Height (feet)	Spread (feet)	Shape: Mounding (M), Spreading (S), Upright (U), Round (R)	Growth Rate: Fast (F), Moderate (M), Slow (S)	Water Needs: Very Low (VL), Low (L), Moderate (M)	Solar Needs: Full-Sun (FS), Part-Shade (PS), Shade (S)	Maintenance Needs	CA Native	Basin		Banks	Upland	Bioretention	Flow-Through Planter	Tree Well Filler	Green Roof*	
<i>Aristida purpurea</i>	Purple Three-Awn	white	2-3	2	U	F	VL	FS	L	●				●	●			Purple seed heads that wave gracefully in the wind; recommended for erosion control on slopes, hillsides, and in canyons. Well-drained soil.	
<i>Bouteloua gracilis</i> 'Blonde Ambition'	Blonde Ambition Blue Grama	chartreuse turning to blonde	1.5-2	1	M	M	L	FS	L	●				●	●			Can be grown from seed; no irrigation needed once established. Adaptable to many soils, prefers well-draining. Showy flowers last summer through winter.	
<i>Calamagrostis x acutiflora</i> 'Karl Foerster'	Feather Reed Grass	light tan	2-3	2-3	U	F	L	PS	L	●				●	●			Background plant. Well-draining.	
<i>Carex barbarae</i>	Santa Barbara Sedge		1-3	1	M	M	L/M	FS	L	●	●	●	●	●	●			Rich green leaves; good for erosion control; little or no summer water. Tolerates damp soil.	
<i>Carex divulsa</i> (C. tumulicola)	Berkeley Sedge		2	2	U	F	L	FS to PS	L	●	●	●	●	●	●			Greenish flowers age to brown in winter and spring. Clay-tolerant; tolerates damp, well-drained soil.	
<i>Carex pansa</i>	Dune Sedge		1	1	M	F	L/M	FS to PS	L	●	●	●	●	●	●			Creeping meadow sedge, good on slopes. Tolerates variety of soil and climate conditions.	
<i>Chandropetalum elephantinum</i>	Large Cape Rush	brown	3-5	4-6	U	M	L/M	FS to PS	L	●	●	●	●	●	●			Tolerates wet well-draining soils and drought. Large striking upright form.	
<i>Chandropetalum tectorum</i>	Small Cape Rush	brown	2-3	3-4	U	M	L	FS	L	●	●	●	●	●	●			Small, unique plant forms broad clumps of thin erect jointed stems; evergreen; good for erosion control. Accepts both dry and wet conditions	
<i>Deschampsia caespitosa</i>	Tufted Hairgrass	creamy white	1-2	2 (flr stalk to 3')	U	M	L	FS to PS	L	●	●	●	●	●	●			green to greenish gold, turning straw color in the winter; they generally maintain good color through the summer, but won't grow much when it is hot. tolerates most soils	
<i>Deschampsia caespitosa</i> ssp. <i>Holciformis</i>	Pacific Hairgrass		1-2	2	U	M	L	FS to PS	L	●	●	●	●	●	●			dense dark green foliage; good choice for erosion control near constant moisture such as marsh, vernal pool or seeps. tolerates most soils	
<i>Festuca californica</i>	California Fescue		2	2	U	M	L	FS to PS	L	●	●	●	●	●	●			Cool season bunchgrass with flower stalks that reach 5 ft. tall and create fountain-like clumps. Beneficial insect plant.	
<i>Festuca glauca</i> 'Elijah Blue'	Blue Fescue		>1	>1	R	F	L	PS	L	●	●	●	●	●	●			Forms clumps of silver-blue leaves; long lived; use as edging, well-drained	
<i>Festuca idahoensis</i>	Blue Bunchgrass		1	1	R	F	L	FS to PS	L	●	●	●	●	●	●			Well-drained	
<i>Helictotrichon sempervirens</i>	Blue Oat Grass	light blue	1-2	1-2	U	M	L	PS	L	●	●	●	●	●	●			Attractive symmetrical form and blue color with straw-colored flower. well-drained	
<i>Juncus patens</i>	Californis Grey Rush	brown	2	1	U	M	L	FS to PS	L	●	●	●	●	●	●			Accepts both dry and wet conditions	
<i>Muhlenbergia rigens</i>	Deer Grass	yellow	4	4-6	R	M	L	FS	L	●	●	●	●	●	●			Clean, dependable form; very rugged. Adaptable.	
<i>Muhlenbergia capillaris</i>	Pink Muhly Grass	pink	4	3-4	R	M	L	PS	L	●	●	●	●	●	●			Showy pink panicles in late summer. well-drained	
<i>Sisyrinchium bellum</i>	Blue-Eyed Grass	blue, yellow	1-1.5	0.5	U	F	VL/L	FS to PS	L	●	●	●	●	●	●	●		Dies back in summer; use as a small accent plant; long green leaves with blue and purple flowers with yellow center; goes dormant in summer. Adaptable	
<i>Stipa arundinacea</i>	New Zealand Wind Grass	NA	3	3	M	F	M*	S to FS	L	●	●	●	●	●	●			Arching olive, amber & gold foliage; cut to 12" in winter. *Some sources state low water req/mt. adaptable.	
<i>Stipa pulchra</i>	Purple Needlegrass		4-6	4-6	U	F	L	FS	L	●	●	●	●	●	●			Long-lived native bunch grass. Adaptable.	

**Notes:**  
Plant selection shall be based upon site-specific conditions.  
\*Greenroof plants require a minimum of 4" growing medium and automatic irrigation with inline drip unless otherwise noted.  
Plants requiring moderate water should be planted in part sun and avoid late afternoon sun exposure on the root crowns.

GROUNDCOVERS & TURF ALTERNATIVES		DESCRIPTION					PLANTING & MAINTENANCE				LANDSCAPE INTEREST/USES	PLANTING ZONES			TREATMENT TYPES				COMMENTS	
Scientific Name	Common Name	Flower Color	Height (feet)	Spread (feet)	Shape: Mounding (M), Spreading (S), Upright (U), Round (R)	Growth Rate: Fast (F), Moderate (M), Slow (S)	Water Needs: Very Low (VL), Low (L), Moderate (M)	Solar Needs: Full-Sun (FS), Part-Shade (PS), Shade (S)	Maintenance Needs	CA Native		Basin	Banks	Upland	Bioretention	Flow-Through Planter	Tree Well Filler	Green Roof*	Turf Block Pavers	
GROUNDCOVERS																				
<i>Arctostaphylos 'Emerald Carpet'</i>	Emerald Carpet Manzanita	white	1-1.5	3-6	S	M	L	FS	L	●	Neat, green, spreader. Adaptable, prefers well-drained	●	●	●	●				Spreads best with even moisture	
<i>Arctostaphylos uva-ursi</i>	Bearberry, Kinnikinnick	blood red	3-12	4-9	S	M	Low	FS	L	●	Set out plants 2' apart for solid cover. Clay-tolerant.	●	●	●	●					
<i>Baccharis pilularis 'Twin Peaks'</i>	Dwarf Coyote Brush	white	1-2	6-10	S	F	L/M	FS	M	●	Small dark green leaves; excellent for erosion control; very important shrub for wildlife. Tolerates most soils.	●	●	●	●					
<i>Fragaria chiloensis</i>	Beach Strawberry	white	6-12"	1-2'	S	F	M	FS to PS	L	●	Spreading groundcover, prefers light, well-drained soils and moisture, partial shade in hotter climates. Flowers in spring followed by edible fruit.	●	●	●	●			●	Prefers 6" growing medium and additional moisture on greenroofs	
<i>Fragaria vesca</i>	Mountain Strawberry; Woodland Strawberry	white	6-12"	1-2'	S	F	M	FS to PS	L	●	Similar to <i>F. chiloensis</i> with smaller leaves and tiny edible and tasty fruit.	●	●	●	●			●	Prefers 6" growing medium and additional moisture on greenroofs	
<i>Grindelia stricta platyphylla</i>	Coastal Gum Plant	yellow	6"	3'	S	M	L	FS	L	●	2" blooms from May thru Fall. Clay, sand & salt tolerant.	●	●	●	●				Prefers 6" growing medium and additional moisture on greenroofs	
<i>Mahonia repens</i>	Creeping Oregon Grape	yellow	2.5'	3-5'	S	M	L/M	PS	M	●	Fall color; Well-draining soil.	●	●	●	●					
<i>Salvia sonomensis</i>	Creeping Sage	purple	2	6-8	S	M	L	FS	M	●	Nice mounding and spreading groundcover with purple/blue flowers; fragrant leaves, especially in summer. Adaptable.	●	●	●	●			●	Prefers 6" growing medium	
<i>Verbena peruviana</i>	Peruvian Verbena	scarlet, white	>1	2-3	S	M	L	FS	M		Set out plants 2' apart for solid cover; offers super vibrant red flowers with small white centers. Well-drained; adaptable.	●	●	●	●					
TURF ALTERNATIVES																				
<i>Bouteloua gracilis</i>	Blue Gramma Grass		1.5-2	1	S	F	L	FS	L	●	irrigate to 1ft to establish; after established needs no irrigation; nice as border planting; okay to mow down to 1.5in	●	●	●	●			●	●	
<i>Buchloe dactyloides</i>	Buffalograss		<1	<1	S	F	VL	FS	L		requires little or no mowing; grows to 4" tall; start from sod or plugs. Adaptable to soil types.	●	●	●	●				●	
<i>Festuca rubra 'molate'</i>	Molate Fescue		1	-	S	F	M/L	FS/PS	M		Prefers part shade, regular water in hot areas, lawn alternative.				●	●		●	●	
<i>Dymondia margaritae</i>	Dymondia, Silver Carpet	yellow	1-3"	1-2'	S	M	M/L	FS	L		Tight ground-hugging groundcover good as turf substitute in small areas. Tolerates heat, sun and cold to 28 degrees.	●	●	●	●				●	
<i>Lippia nodiflora</i>	Kurapia	white	1"-3"	-	S	M	L	FS/PS	L		Spreading groundcover from Japan. Tolerates periodic inundation. Flowers can attract bees.	●	●	●	●			●	Prefers 6" growing medium	
NA	Biofiltration Sod		<1	<1	S	F	M	FS	L		Tolerates periodic inundation.	●			●	●				
NA	Native, No-Mow Sod		<1	<1	S	S	M/L	FS/PS	L	●	Slow growing, narrow leafed grass with blades that are very lax and flexuous. Provides soil stabilization for sloped areas. Can be mowed as turf lawn, or left unmowed.	●	●	●	●			●	●	

**Notes:**  
Plant selection shall be based upon site-specific conditions.  
\*Greenroof plants require a minimum of 4" growing medium and automatic irrigation with inline drip unless otherwise noted.  
Plants requiring moderate water should be planted in part sun and avoid late afternoon sun exposure on the root crowns.

PERENNIALS		DESCRIPTION					PLANTING & MAINTENANCE					LANDSCAPE INTEREST/USES	PLANTING ZONES			TREATMENT TYPES			COMMENTS
Scientific Name	Common Name	Flower Color	Height (feet)	Spread (feet)	Shape: Mounding (M), Spreading (S), Upright (U), Round (R)	Growth Rate: Fast (F), Moderate (M), Slow (S)	Water Needs: Very Low (VL), Low (L), Moderate (M)	Solar Needs: Full-Sun (FS), Part-Shade (PS), Shade (S)	Maintenance Needs	CA Native		Basin	Banks	Upland	Bioretention	Flow-Through Planter	Green Roof*		
<i>Achillea millefolium</i>	Common Yarrow	white	3	2	S	F	L	FS	L	●		●	●	●	●	●		Maintenance challenges; longevity issues	
<i>Achillea filipendulina</i>	Fern-Leaf Yarrow	golden	3-4	2-3	U	M	L	FS	M			●	●	●	●	●			
<i>Armeria maritima</i>	Sea Pink	pink	1	1	M	S	L-M	FS	L			●	●	●	●	●		Maintenance challenges; longevity issues	
<i>Anigozanthus spp.</i>	Kangaroo Paw	red, purple, green, yellow	to 6	to 3	U	F	L	FS	L			●	●	●	●			Unattractive if subject to freezing or standing water	
<i>Coreopsis grandiflora</i>	Coreopsis	purple-blue	1.5-2.5	2-3	S	M	L	FS	L			●	●	●	●	●			
<i>Dietes iridioides</i>	Fortnight Lily	pale yellow; light blue; white	up to 3	1-1.5	U	M	L	FS	L			●	●	●	●			Disruptive to planting/soil when pulled up and divided every 5 years	
<i>Echeveria spp.</i>	Hens and Chicks	pink	varies			M	L/VL	FS	L			●	●	●	●	●			
<i>Epilobium bowman</i>	Bowman California Fuchsia	orange	varies	1.5-3	S	F	L	FS	L	●		●	●	●	●				
<i>Epilobium canum</i>	California Fuchsia	orange-red	varies	1.5-3	S	F	L	FS	L	●		●	●	●	●				
<i>Erigeron glaucus</i> 'Wayne Roderick'	Wayne Roderick Daisy	lavender	1	3	M	M	M	FS to PS	L	●		●	●	●	●				
<i>Erigeron karwinskianus</i>	Santa Barbara Daisy	white with pink tinge	10-18"	2-3'	M	F	L-M	FS to PS	L	●		●	●	●	●			Reseeds	
<i>Eriogonum grande var. rubescens</i>	Red-Flowered Buckwheat	rosy red	1-2'	1-2'	S	F	L	FS to PS	L	●		●	●	●	●			Reseeds	
<i>Eriogonum latifolium</i>	Coast Buckwheat	pink, white	6	6	S	F	Low	FS	Low	●		●	●	●	●	●			
<i>Eschscholzia californica</i>	California Poppy	orange	1.5	1.5-2	S	F	VL	FS	L	●		●	●	●	●	●		Maintenance challenges; longevity issues	
<i>Gaillardia grandiflora</i>	Blanket Flower	varies	2-3	1-2	U	M	L	FS	L			●	●	●	●	●		Prefers 6" planting medium	
<i>Gaura lindheimeri</i>	Gaura	white	2.5-4	2-3	U	M	L/M	FS	M			●	●	●	●			More drought tolerant in Zone 17; Can self-sow	
<i>Heuchera maxima</i>	Island Alum Root	white, pink	1-2	3-4	S	M	L	PS	L	●		●	●	●	●				
<i>Iris douglasiana</i>	Douglas Iris	varies	1.5	1.5	S	M	L	PS	L	●		●	●	●	●			Maintenance challenges; longevity issues	
<i>Mimulus aurantiacus</i>	Sticky Monkey Flower	varies	3-4	3-4	M	M	L	FS to PS	L	●		●	●	●	●			Can be short-lived, 3 years; Maintenance challenges; longevity issues	
<i>Mimulus aurantiacus var. puniceus</i>	Red Monkey Flower	red	3-4	3-4	M	M	L	FS to PS	L	●		●	●	●	●			Can be short-lived, 3 years; Maintenance challenges; longevity issues	
<i>Monardella villosa</i>	Coyote Mint	light purple	2	2	M	F	VL	FS to PS	L	●		●	●	●	●	●		Prefers 6" growing medium; Maintenance challenges; longevity issues	
<i>Penstemon heterophyllus</i> 'Blue Springs'	Foothill Penstemon	Iridescent blue-purple	1-2	2	M	F	L	FS	M	●		●	●	●	●	●		Prefers 6" planting medium	
<i>Sedum sp. (many)</i>	Stone Crop	varies	varies		S	M	L	FS	L			●	●	●	●	●			
<i>Tulbaghia violacea</i>	Society Garlic	pink	2	1	M	F	L	FS	L			●	●	●	●				
<i>Verbena lilacina</i>	De La Mina Lilac	purple	3	3	S	M	L	S to PS	L			●	●	●	●				

**Notes:**  
Plant selection shall be based upon site-specific conditions.  
\*Greenroof plants require a minimum of 4" growing medium and automatic irrigation with inline drip unless otherwise noted.  
Taller shrubs and perennials with more substantial roots systems can be grown on green roofs with 18" growing medium.

## A.3 Planting Specifications

Planting plans and specifications should be prepared by a qualified professional and coordinated with other site development details and specifications including earthwork, soil preparation and irrigation (if used). Plans indicating a planting layout, with species composition and density, should be prepared on a site-specific basis. Reference the Bay-Friendly Landscaping Guidelines (available at [www.ReScapeCa.org](http://www.ReScapeCa.org)), which outline principles and practices to minimize waste, protect air and water quality, conserve energy and water, and protect natural ecosystems, including:

- Evaluate site and assess the soil;
- Consider potential for fire;
- Select plants for appropriate size upon maturity, do not over-plant;
- Irrigation, if required, should be designed as a high efficiency, water conserving system; and
- Utilize compost (see the specification in the Bay-Friendly Landscaping Guidelines) and mulch to build healthy soils and increase the water holding capacity of the soil.

### *Propagation and Planting Methods*

The propagation methods for different species will vary, depending upon type of plant and stormwater adaptation. In general, container stock will be utilized most commonly for green roofs, flow-through planters, tree well filters, vegetated swales and infiltration trenches. Bioretention areas and extended detention basins will generally utilize native plants available as transplants (plugs), pole cuttings and seed mixes.

**Container Stock.** Planting holes for container stock should be twice as wide and only as deep as the container size. Plant spacing should be determined on a site-specific basis. When planting, the root collar and base of the stem should be 1" above the adjacent soil surface. Soils should be backfilled and tamped down to assure contact with the roots. Ensure that supplemental water has direct contact with the root ball of the plant. The planting should be watered-in promptly to promote the settling of soil. Planting berms for water retention and mulch should be used to enhance plant establishment, but berms should not touch or be within 6" of the trunk or trunk flare of trees. Trees should be staked or guyed to provide interim support until established.

**Transplants (Plugs).** Transplanted plant divisions, referred to here as "plugs", should be planted during the fall dormant period, preferably between October 1 and November 15 after first soaking rain. Temporary supplemental irrigation may be necessary to help plants withstand dry periods until they are established. Plugs should be collected from a suitable collection site in the vicinity of the constructed basins. Plugs are clumps of plant roots, rhizomes or tubers combined with associated soil that can be manually removed, or salvaged with an excavator or backhoe. The maximum recommended size is 1 foot x 1 foot. Whole plants or plant divisions can be utilized. The plugs should be from healthy specimens free of insects, weeds and disease. The plugs should be spaced from 1 foot to 6 feet apart, depending on the size of the plug. Smaller plugs can be planted at the minimum distance to promote faster spreading and cover. Larger plugs from cattail and bulrush species should be planted at 3-foot to 6-foot intervals.

To plant a plug, a hole slightly wider than the diameter of the plug should be prepared and the roots system of the plug placed in the hole. Do not over-excavate the hole depth or the plant will settle below grade. A shovel could be used to create the planting hole. Manual planting with a spade is recommended for wet soils. Power augers can be used for creating holes in dry soils. Alternatively, a trench could be created along the narrow axis of the extended detention basin, and planting material manually placed at specified elevations in relation to the proximity of permanently saturated soils. To plant a plug with an established root system, the base of the stem and top of the root collar should be level with the ground surface. Tubers should be secured to prevent floating. Rhizomes should be placed in the soil with a slight upward angle.

The hole or trench containing the plug(s) should be backfilled with soil and the soil tamped down to assure good soil contact and secure the plug. The vegetative portion of the plant should be cut back to prevent water loss and wilting and encourage the growth of roots and new shoots. Plugs of wetland plants should be grown in saturated soil. The soil should not be allowed to dry out after planting. Plugs should be planted immediately, when possible. When necessary, plugs can be stored in a cool, moist, shaded location for a maximum of one day. Plants must be thoroughly watered. See “Water Level Management and Irrigation for Plant Establishment” section below for more information.

**Pole Cuttings.** Pole cuttings should be collected from the 1-year old wood of dormant trees and have a minimum of 5 viable nodes. The parent material should be healthy and free of diseases. The basal area of the pole cutting should be a minimum of one to two inches in diameter; however, the diameter at the base should not exceed 2 inches. The optimum diameter width of the base is 1 inch. The length of the cutting should be a minimum of 2 feet and should not exceed a maximum of 4 feet in length. Generally, 75 percent of the length of the cutting should be planted beneath the soil surface.

Pole cuttings should be collected no more than 2 days prior to planting. Cuttings should be placed in cool water to promote swelling of the nodes. Water should be kept fresh by aeration and/or by daily replacement. The pole cuttings should be placed in a hole approximately 3 feet deep (as determined by the length of the cutting) and backfilled with native soil, or a rich organic medium mixed with native soil. Soil should be tamped down to remove air pockets and assure soil contact with the cutting. See “Water Level Management and Irrigation for Plant Establishment” section below for more information.

**Seeding.** Seeding should be conducted after plugs, container stock and pole cuttings are installed. Hydroseeding or broadcast method should be utilized as appropriate for the size and accessibility of the area. The soil surface should be scarified prior to seeding. Do not damage previously planted vegetation. The seeds should be planted in fall, ideally in October.

Seeds should be broadcast or hydroseeded over the specified planting area. With broadcast seeding, the seed should be applied with hand-held spreaders to scarified soil. The soil surface should then be raked to cover the seeds with about one-eighth to one-quarter inch of soil to discourage predation, and tamped or rolled to firm soil surface.

Seeds should be planted at the ratios and rates specified by the supplier. The seed should be free of weeds and diseases. The certified germination percentage should be provided by the supplier. Temporary supplemental irrigation may be necessary to assist germination until rain events occur and/or until plant material is established. See “Water Level Management and Irrigation for Plant Establishment” section below for more information.

## *Water Level Management and Irrigation for Plant Establishment*

All newly planted material will need careful attention to watering requirements to ensure proper establishment. As mentioned in the introduction, it is important to select plants based on specific site conditions, which will affect the availability of water for plant use. In addition, grouping plants with similar water requirements can help reduce irrigation needs. The specific approach will vary for irrigated and non-irrigated conditions, and for each stormwater application. In most cases, stormwater applications will require a permanent irrigation system which should be designed to maximize water conservation. Irrigation specifications and design plans should be provided. Refer to the local agency's WELO or the State of California's Model Water Efficient Landscape Ordinance (MWELO) for guidance on irrigation requirements.

Biotreatment soil media is very permeable, so water will not spread out as it moves downward through the media, as is typical with regular soil, therefore place irrigation emitters close to plant roots. Replacement or subdivided plants may also need to have irrigation emitters relocated.

Plants such as shrubs and trees grown in naturalized areas that are not saturated to the surface or inundated should be irrigated with drip irrigation or low volume bubblers. The irrigation system should remain in place for a minimum of three years and should continue until it is demonstrated that the plantings can survive on annual rainfall and/or groundwater. Seeded areas do not need irrigation in years of normal rainfall. If a period of drought occurs after seeding, supplemental watering may be needed for germination in the first year.

The plants on the bottom and edge of the constructed basins should be allowed to become established for one growing season prior to the onset of significant flooding that will inundate the plantings for extended periods. The types of plants recommended for these locations are rushes, sedges, grasses and herbaceous species. Initially, saturated soils are required for the bioretention areas and extended detention basins during the establishment period of the plantings. After the plants have become established, inundation with a surface depth of 1 cm to 2 cm alternating with short dry periods is recommended for the basins during the first year. Periodic shallow flooding of these basins can slow the growth of non-native weedy terrestrial species in the wetland system; however, the water depth should not be greater than the height of the plants. This initial irrigation regime will prevent plant mortality from dry periods or excessive flooding in the first year and reduce the growth of non-native weedy species.

Emergent species should be planted in saturated soil so the plants will become established. For emergent species, the water level in the first year should be maintained to allow for soil saturation or shallow inundation around the base of the plants. Significant flooding and inundation of stems and leaves of the plants should be avoided during the first year. Tall plugs and plantings can tolerate greater depths of inundation if a significant portion of the stems and leaves of the plantings remain above the water surface.

## *A.4 Planting Tips for Single-Family Homes*

It is recommended that homeowners and builders follow the practices of Bay-Friendly Landscaping and Integrated Pest Management (see Section A.6) to minimize pesticide usage and over-watering. Planting tips for single-family homes include:

- Avoid using invasive species such as iceplant and eucalyptus;
- Minimize turf grass areas to reduce need for fertilizer and excessive watering;
- Use appropriate species for soil and climate conditions; and
- Use compost instead of fertilizer.

Please review Chapter 8 for complete information on ReScape’s eight regenerative landscaping principles and Integrated Pest Management.

## A.5 Nursery Sources for Native Plants

It is recommended that the native plants used in treatment controls be grown by a qualified nursery. Seed collection should be conducted by a qualified botanist and/or nursery staff. Seed should be collected locally from selected sites to maintain the genetic integrity of the native plant species. The seeds should be propagated by the nursery for planting during the fall dormant season. The appropriate container size for each species should be used by the nursery. An asterisk (\*) indicates a nursery with a dedicated native plant section.

### California Native Plant Society Nursery List

[www.cnps-scv.org/index.php/gardening/39-gardening-with-natives/356-where-to-buy-native-plants](http://www.cnps-scv.org/index.php/gardening/39-gardening-with-natives/356-where-to-buy-native-plants)

#### Berkeley Horticultural Nursery\*

1310 McGee Ave., Berkeley, CA

510-526-4704

[www.berkeleyhort.com/](http://www.berkeleyhort.com/)

#### Clyde Robin Seed Company

Castro Valley, CA

510-785-0425

[www.clyderobin.com](http://www.clyderobin.com)

#### Devil Mountain Wholesale Nursery

9885 Alcosta Boulevard, San Ramon, California 94583

(925) 829-6006

<https://devilmountainnursery.com>

#### East Bay Nursery\*

2332 San Pablo Ave., Berkeley, CA

510- 845-6490

[www.eastbaynursery.com/](http://www.eastbaynursery.com/)

#### Golden Nursery

1122 2<sup>nd</sup> Street, San Mateo, CA 94401

(650) 348-5525

[www.goldennursery.com](http://www.goldennursery.com)

#### Larner Seeds

PO Box 407, Bolinas, California

415-868-9407

info@larnerseeds.com

[webmaster@larnerseeds.com](mailto:webmaster@larnerseeds.com)

#### Mines Road Natives

17505 Mines Road, Livermore, CA

925-371-0887

Note: by appointment only.



Mostly Natives Nursery  
27235 Highway 1, Tomales, CA  
707-878-2009  
[www.mostlynatives.com](http://www.mostlynatives.com)

Mountain States Wholesale Nursery  
(626) 274-1956  
<https://mswn.com/>

Native Here Nursery  
101 Golf Course Road, Berkeley, CA  
510-549-0211  
[www.nativeherenursery.org/](http://www.nativeherenursery.org/)

Oaktown Native Plant Nursery  
702 Channing Way, Berkeley, CA  
510-387-9744  
[www.oaktownnativenursery.info/](http://www.oaktownnativenursery.info/)

Pacific Coast Seed  
533 Hawthorne Place, Livermore, CA  
925- 373-4417  
[www.pcseed.com](http://www.pcseed.com)

Redwood City Nursery  
2760 El Camino Real, Redwood City, CA 94061  
(650) 368-0357  
[www.rcnursery.com](http://www.rcnursery.com)

Watershed Nursery  
601 A Canal Blvd., Richmond, CA 94804  
(510) 234-2222  
[www.watershednursery.com](http://www.watershednursery.com)

Wegman's Nursery  
492 Woodside Road, Redwood City, CA 94061  
(650)368-5821  
[www.wegmansnursery.com/](http://www.wegmansnursery.com/)

Yerba Buena Nursery  
19500 Skyline Blvd., Woodside, CA 94062  
(650) 851-1668  
[www.yerbabuenanursery.com](http://www.yerbabuenanursery.com)

## A.6 Trees, Rootable Soil Volume and Suspended Pavement Systems

**Rootable soil volume** is one of the most important metrics to use for achieving tree health and growth. At the average planting site, street trees and trees in parking lots are often dropped into holes with 30-100 cubic feet of soil volume for roots to grow in. Around the hole, compacted soil supports pavement. This tiny hole with compacted soil all around it is woefully inadequate for tree growth and explains why so many trees either die, become stunted or heave adjacent pavement and curbs in order to find places to grow. In order to thrive, trees need soil that can provide oxygen, water, nutrients, microbial life, and structural support.

More and more developers (and public agencies) around the world are realizing that a minimum volume of soil must be provided in order to allow trees to have healthy and long lives without impacting surrounding infrastructure. Pavement lifted by roots is a tripping hazard which can result in expensive lawsuits. Therefore, standards that require the provision of minimum amounts of soil volume at the time of planting based on the size of the tree species at maturity, space available, and/or other metrics have been developed. A Bay Area example of a typical new tree planting requirement is that used in the City of Emeryville, which requires a minimum of 600, 900, and 1200 cubic feet of soil volume per new tree for small, medium and large species respectively. A minimal depth of 3 feet is also typically recommended (see GI Design Guide).

By requiring minimum rootable soil volumes, a key aspect of the long-term growth of a tree is planned for, which reduces the risk of it becoming a liability. In fact, if proper planting standards are met and strategic pruning is provided, trees can yield a net positive triple bottom line benefit instead of a negative one – even with the increased up-front costs of providing more soil volume for a new tree. In one study<sup>3</sup> by DeepRoot Green Infrastructure, the costs and benefits of planting trees in the standard way were compared with the costs and benefits of planting trees with increased soil volumes and then the results were modeled over a 50-year period. In the standard case, the model assumed that the trees would be replanted three times over the 50-year period using an average tree life expectancy of 13 years. The model yielded a net cost of \$3,094 per tree, compared to a net benefit of \$25,427 per tree in the alternative case with increased soil volumes, over the 50-year period. This is despite the much higher upfront costs for the new tree with more soil volume. The study used a cost of \$1,000 per standard new tree and \$14,000 per tree with increased soil volume using suspended pavement systems to provide the increase. The study shows that large species trees that are planted correctly at the beginning of their lives will reap long-term benefits far surpassing the upfront costs.

Strategies for planting small, medium and large species of trees with different soil volume amounts are shown in Figure 4-2. The image is taken from Washington D.C.'s District Department of Transportation (DDOT) and its Greening DC Streets Manual. The figure illustrates examples of how rootable (85% or less compaction) soil volumes can be achieved in three different scenarios:

1. An open soil area in a typical planter strip;
2. A combination of open soil area and partial underground area using suspended pavement systems; and

---

<sup>3</sup> [www.deeproot.com/silvapdfs/resources/articles/LifecycleCostAnalysis.pdf](http://www.deeproot.com/silvapdfs/resources/articles/LifecycleCostAnalysis.pdf)

## A.6 Tree, Rootable Soil Volume and Suspended Pavement Systems

3. A combination of open soil area with the majority of soil volume provided underground using suspended pavement systems.

The typical depth of the soil volume provided is 3 to 4 feet. The soil volume quantities of 600, 1,000 and 1,500 cubic feet are the required amounts for DDOT (local permitting jurisdiction standards may vary). Narrow canopy trees are not recommended for stormwater interception and treatment systems. Adjacent trees may also be allowed to share soil volumes in some jurisdictions resulting in a lower total amount of soil volume needing to be provided per tree.

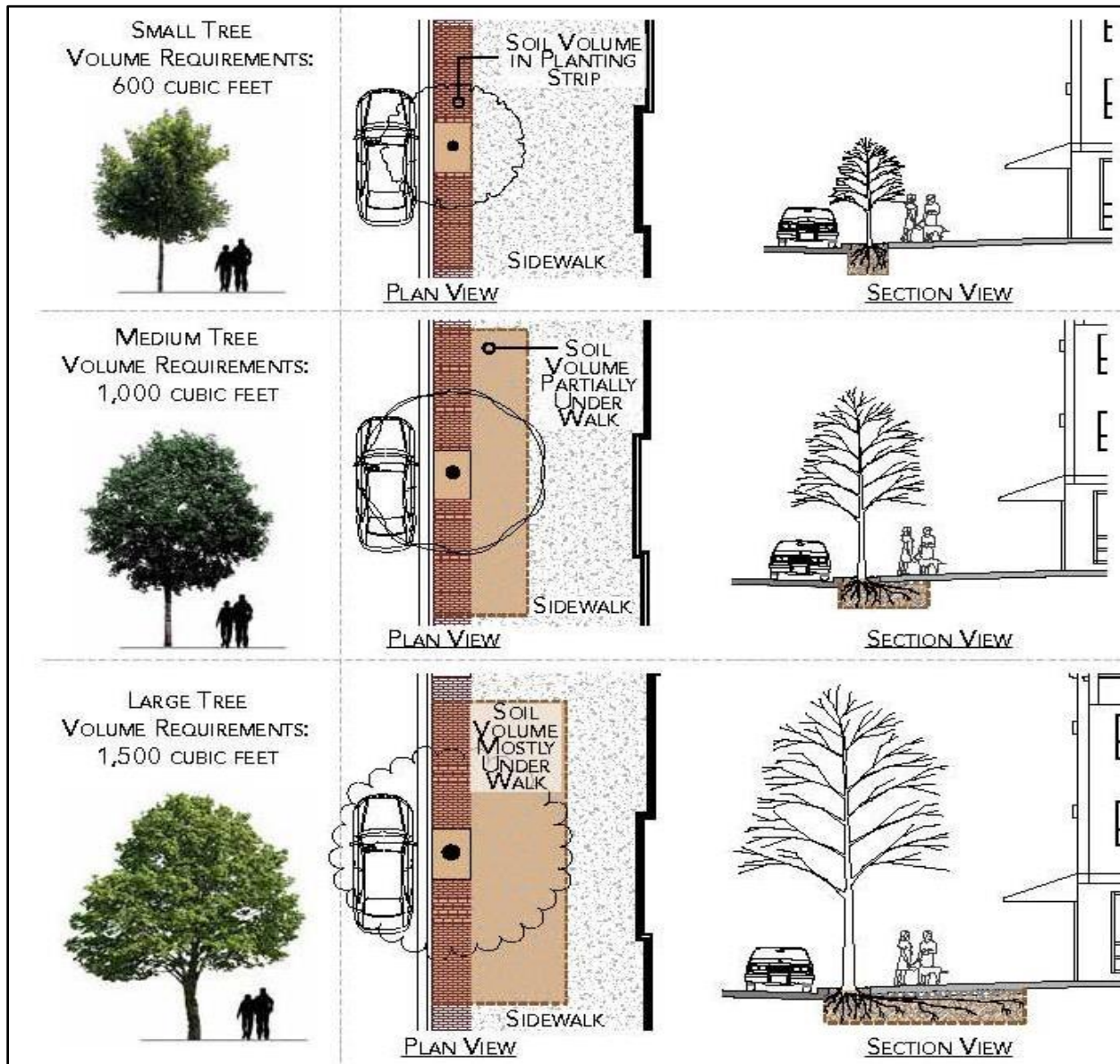


Figure 5-28. Strategies for small, medium and large tree species. (Courtesy of DDOT)

Soil volumes can be provided using open landscaped areas such as planting strips (as long as the soil is not overly compacted and is a good quality soil to a depth of at least three feet). Where limited open space is available for planting trees and roots may damage hardscape, consider the use of **suspended pavement systems**. One type of suspended pavement system is **structural soil**. It is a planting medium that consists of a stone skeleton structure for strength and clay soil for water retention, which allows trees to grow under pavement. The structural soil system creates a load-bearing matrix with voids filled with soil and air - essential for tree health. Increased void space and reduced compaction allows for larger amounts of oxygen in the soil, improved tree growth rates, better overall health of trees, and reduced pavement uplifting by tree roots. The voids that benefit the tree roots also provide increased stormwater storage capacity, allowing tree pits in paved areas to serve as a series of small detention basins<sup>4</sup>. However, structural soils provide minimal (approximately 20%) amounts of soil because the majority of the space is taken up by the rock and void space.

**Modular suspended pavement systems** (also known as load-bearing modular grid products), use modules such as the Silva Cell and Stratavault systems, to support pavement and provide improved tree rooting conditions. These products were developed to allow the planting of trees in lightly compacted topsoil or biotreatment soil media (BSM), extending under sidewalks and other areas of pavement. With the Silva Cell product, each cell is composed of a base, six posts and a deck (see Figure 4-3). The posts come in different heights depending on the design and depth of soil to be achieved. The posts are placed on the base, filled with soil and topped with a deck to create a maximum amount of soil volume for tree root growth and stormwater treatment under pavement. Modules can be installed laterally as wide as necessary. Modules can also be designed to accommodate utilities.

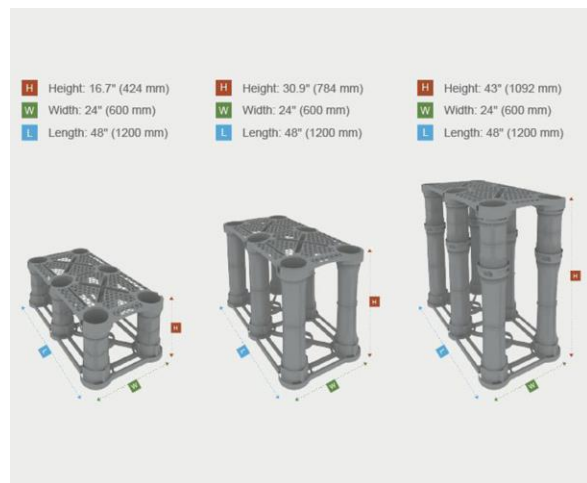


Figure 5-29: Silva Cells, in three heights.  
(Credit: DeepRoot Green Infrastructure)

An additional strategy used to provide trees with adequate soil volumes is related to the planting of trees in places where there is an adjacent landscaped area. If the adjacent area is separated from the tree planting location by impervious surfaces such as sidewalks or parking areas, then suspended pavement systems can be used to provide an uncompacted soil “bridge” or “root channel” between the two landscaped areas allowing roots to grow through and under that pavement to the adjacent landscaped area without heaving of the pavement over time. This strategy can be even more important if the adjacent landscaped area contains a clayey/loamy soil with good water retention compared to the sandy BSM used in bioretention areas. With the expectation of recurrent droughts in the future, loamy soils are a good option for retaining water for trees during the dry season, thereby reducing the need for irrigation. This is important to consider in areas where irrigation with potable water and other types of water such as recycled water, harvested rainwater and graywater may be limited and needed for other purposes.

<sup>4</sup> See <https://blogs.cornell.edu/urbanhort/outreach/cu-structural-soil/> for more information on structural soils.

Stormwater treatment landscapes can be more resilient if they are not dependent on irrigation alone – especially irrigation with potable water. Techniques to reduce or eliminate irrigation using potable water should be considered. For more information on how to integrate trees and bioretention, refer to Section 6.3.

## A.7 References

[www.StopWaste.Org](http://www.StopWaste.Org) and [www.ReScapeCa.org](http://www.ReScapeCa.org)

- Bay-Friendly Landscape Guidelines
- A Landscaper’s Guide to Grasscycling
- A Landscaper’s Guide to Mulch

A Guide to Estimating Irrigation of Water Needs of Landscape Plantings, California Dept of Water Resources, <http://cdec.water.ca.gov>.

Irrigation water audits, Irrigation Association, [www.irrigation.org](http://www.irrigation.org), and the Irrigation Technology Research Center, [www.itrc.org](http://www.itrc.org).

California Irrigation Management Information System, [www.cimis.water.ca.gov](http://www.cimis.water.ca.gov), Waste management and recycling, [www.calrecycle.ca.gov](http://www.calrecycle.ca.gov).

The Weed Worker’s Handbook, A Guide to Techniques for Removing Bay Area Invasive Plants, the Watershed Council, (510) 231-5655

Pests of Landscape Trees and Shrubs: An Integrated Pest Management Guide, 2nd ed., UC Publication 3359, [www.ipm.ucdavis.edu](http://www.ipm.ucdavis.edu).

A Field Guide to Compost Use, The Composting Council, Alexandria, VA. [www.compostingcouncil.org/index.cfm](http://www.compostingcouncil.org/index.cfm).

City of Santa Rosa. 2005. Appendix A. Landscaping and Vegetation for Storm Water Best Management Practices in New Development and Redevelopment in the Santa Rosa Area.

Hogan, E.L., Ed. 1994. Sunset Western Garden Book, Sunset Publishing Corporation, Menlo Park, CA.

California Stormwater Quality Association (CASQA). Stormwater BMP Handbook: New Development and Redevelopment. January 2003.

California Invasive Plant Council (510) 843-3902, [www.CAL-IPC.org](http://www.CAL-IPC.org)

Calscape, A database of plants native to California, California Native Plant Society, <https://calscape.org/>

Calflora, A database of wild California plants, <https://www.calflora.org/>

Water Use Classification of Landscape Species, UC Davis, <https://wucols-frontend.ucdavis.edu/#/search>

# Appendix B: Example Scenarios

<i>B.1 Parking-Lot Example</i> .....	B-2
<i>B.2 Podium Type Building Example</i> .....	B-4
<i>B.3 Sizing Worksheets</i> .....	B-7

### B.1 Parking-Lot Example

#### Introduction

This example shows a proposed parking lot in San Mateo County with bioretention as the method of stormwater treatment, and demonstrates the use of the “4 percent method” (see Chapter 5, Section 5.1) for sizing bioretention facilities.



Figure B-1: Aerial view of a parking-Lot

#### Summary of Stormwater Controls

##### Site Design Measures

- Some of the landscaped areas are designed to function as self-treating (S-T) areas

##### Source Control Measures

- Stenciling storm drain inlets
- Parking lot sweeping
- Landscape architect will be asked to select drought tolerant plants and specify maintenance with IPM techniques

##### Treatment Measures

- Bioretention facilities

#### Example Parking Lot Site Description

- The project site is 1.2 acres with 1% slope from edge of lot to street.
- Sidewalks will be graded toward landscaped areas.
- The parking lot will have some landscaping as an amenity (not used for stormwater treatment).
- All areas will be graded to drain to bioretention facilities along the perimeter of the site. There are two drainage management areas.



## B.1 Parking-Lot Example

The site was divided into drainage management areas (DMAs). DMAs A and B each drain to one bioretention facility. The self-treating (S-T) areas do not need to drain to a treatment measure. The DMA data is as follows:

DMA	Impervious Area (sf)	Pervious Area (sf)	Total Area (sf)
A	6,788	7,868	14,656
B	24,491	0	24,491
S-T Areas	0	13,125	13,125
Totals	31,279	20,993	52,272



Figure B-2: Examples of Bioretention Areas

### Procedure for BMP Sizing (4 Percent Method)

Use the following procedure for sizing bioretention facilities using the 4 percent method (perform for each DMA and treatment measure):

1. List the area of impervious surface and the area of pervious surface (if any) that drains to the treatment measure.
2. Multiply the pervious area by a factor of 0.1.
3. Add the product obtained in Step 2 to the area of impervious surface to obtain the “effective impervious area.”
4. Multiply the effective impervious area by a factor of 0.04. This is the required surface area of the bioretention facility.

## B.2 Podium-Type Building Example

Results of Steps 1 through 4 for the example DMAs are shown below:

DMA	Impervious Area (sf)	Pervious Area (sf)	Pervious Area x 0.1 (sf)	Effective Impervious Area (EIA) (sf)	EIA * 0.04 (sf)
A	6,788	7,868	786.8	7,575	303
B	24,491	0	0	24,491	980

## B.2 Podium-Type Building Example

### Introduction

This example consists of a proposed podium type building in San Mateo County, with flow-through planters as the method of stormwater treatment. The flow-through planters are sized using the combination flow and volume sizing method.



Figure B-3: Building with opportunities for podium-type treatment measures

### Summary of Stormwater Controls

#### Site Design Measures

- Multistory building above covered parking structure (minimized surface parking)

#### Source Control Measures

- Covered trash storage areas
- Landscape architect will be asked to select drought tolerant plants and specify maintenance with IPM techniques

#### Treatment Measures

- Flow-through planters

### Example Podium Type Development Description

- The project site is approximately 25,000 square feet.
- Lot line is assumed to be to the edge of city right-of-way (sidewalks).

## B.2 Podium-Type Building Example

- The podium building is a mixed-use building with residential units on the top floors, retail space on the second floor and parking on the bottom floor.
- The ground floor is a concrete slab with buildings and a covered parking structure. There is no potential for infiltration.
- The podium building roof area is 15,000 square feet.
- There is a 9,000 square foot concrete patio on the top of the podium in the center of the building.
- Treatment will be provided using flow-through planters in the center of the building around the concrete patio and down at ground level.
- Runoff will be conveyed to the treatment measures via roof leaders and sheet flow.
- Flow-through planters will be designed per the guidelines in Section 6.2 of the C.3 Technical Guidance Manual.
- Off-site sidewalks and driveways will be graded toward street (stormwater treatment not required).



Figure B-4: Typical Flow-Through Planters on-grade (left) and on podium level (right)

### Procedure for BMP Sizing (Combination Flow and Volume Method):

For bioretention areas and flow-through planters, the following approach may be used to take into consideration both the flow of stormwater through the planting media and the volume of stormwater in the surface ponding area. This treatment system design approach meets both the flow-based and volume-based criteria in MRP Provision C.3.d. Note that the approach assumes that all of the design rainfall becomes runoff, and thus it is appropriate for use where the drainage area to the bioretention area is mostly impervious (contributing pervious area should be converted to effective impervious areas by multiplying by a runoff coefficient of 0.1).

The steps below describe the calculations for sizing the example podium building treatment measures, using the combination flow and volume method described in Chapter 5, Section 5.1, and the following assumptions:

- Design flow criterion: rainfall intensity = 0.2 in/hr
- Design volume criterion: capture 80% of the average annual runoff

## B.2 Podium-Type Building Example

- The project site is located in Rainfall Region 4, per the rainfall region map in Appendix C, and has a mean annual precipitation (MAP) of 16 inches
  - The surface loading rate for the biotreatment soil is 5 in/hr
  - Desired ponding depth is approximately 6 inches
1. List the DMAs draining to each treatment measure (note that for this example, it is assumed that all the runoff drains to one large flow-through planter):
    - Impervious Patio Surfaces: 9,000 square feet
    - Roof Surfaces: 15,000 square feet
    - Total Impervious Area: 24,000 square feet**
  2. Determine the unit basin storage volume for 80 Percent Capture with 48-hour drawdown using Table 5-2 of Chapter 5 based on an effective impervious area runoff coefficient of 1.0. Adjust this volume based on the ratio of the MAP at the site to the MAP at the nearest rain gage.

Region 4 (Palo Alto gage) has a MAP of 14.6 inches and a unit basin storage volume of 0.64 inches. The MAP at the site is 16 inches. Therefore, the unit basin storage volume at the site =  $(0.64 \text{ in.} \times 16/14.6) = \mathbf{0.7 \text{ inches}}$ .
  3. Calculate the water quality design volume by multiplying the total impervious area from Step 1 times the adjusted unit basin storage volume from Step 2.  $(24,000 \text{ sq. ft.} \times 0.7'' \times 1/12 \text{ feet per inch} = \mathbf{1,403 \text{ cubic feet.}}$ )
  4. Assume that the rain event that generates the design volume of runoff determined in Step 3 occurs at a constant intensity of 0.2 in/hr from the start of the storm (i.e., assume a rectangular hydrograph). Calculate the duration of the rain event by dividing the adjusted unit basin storage volume from Step 2 by the intensity. In other words, determine the amount of time required for the adjusted unit basin storage volume to be achieved at a rate of 0.2 in/hr.

For this example, with an adjusted unit basin storage volume of 0.7 inches, the rain event duration =  $(0.7 \text{ in.} \div 0.2 \text{ in/hr}) = \mathbf{3.5 \text{ hours}}$ .
  5. Make a preliminary estimate of the surface area of the bioretention facility or flow-through planter by using the 4% method (i.e., multiplying the area of impervious surface in Step 1 by a sizing factor of 0.04).

For this example,  $24,000 \text{ sq. ft.} \times 0.04 = \mathbf{960 \text{ square feet}}$  of surface area
  6. Assume a surface area that is about 25% smaller than the area calculated in Step 5. Using the example above,  $960 - (0.25 \times 960) = \mathbf{720 \text{ square feet}}$ .

## B.3 Sizing Worksheets

7. Calculate the volume of runoff that filters through the treatment soil at a rate of 5 inches per hour (the design surface loading rate), for the duration of the rain event calculated in Step 4.

For this example, with a surface area of 720 square feet and an infiltration rate of 5 in/hr for a duration of 3.5 hours:

Volume of treated runoff = 720 sq. ft. × 5 in/hr × (1 ft/12 in) × 3.5 hrs = **1,052 cubic feet**.

8. Calculate the portion of the water quality design volume remaining after treatment is accomplished by filtering through the treatment soil. The result is the amount that must be stored in the ponding area above the reduced surface area assumed in Step 6.

For this example, the amount remaining to be stored comparing Step 3 and Step 7 is 1,403 cu. ft. – 1,052 cu. ft. = **351 cubic feet**.

If this volume is stored over a surface area of 720 square feet, the average ponding depth would be 351 cu. ft. ÷ 720 sq. ft. × 12 in/ft = **5.8 inches**.

9. The final step is to check if the average ponding depth is between 6 and 12 inches, which is the recommended range for ponding in a flow-through planter. (Check with the local municipality to determine what is allowed.) If the ponding depth is less than 6 inches, the bioretention design can be optimized with a smaller surface area (i.e., repeat Steps 7 and 8 with a smaller area). If the ponding depth is greater than 12 inches, a larger surface area will be required.

In this example, the recommended size of the flow-through planter is 715 square feet with a ponding depth of 6 inches.

## B.3 Sizing Worksheets

The Countywide Program has developed Excel-based worksheets for sizing treatment measures using the volume-based method and the combination flow and volume-based method. The worksheets are available for download from the Countywide Program's website at the following link:

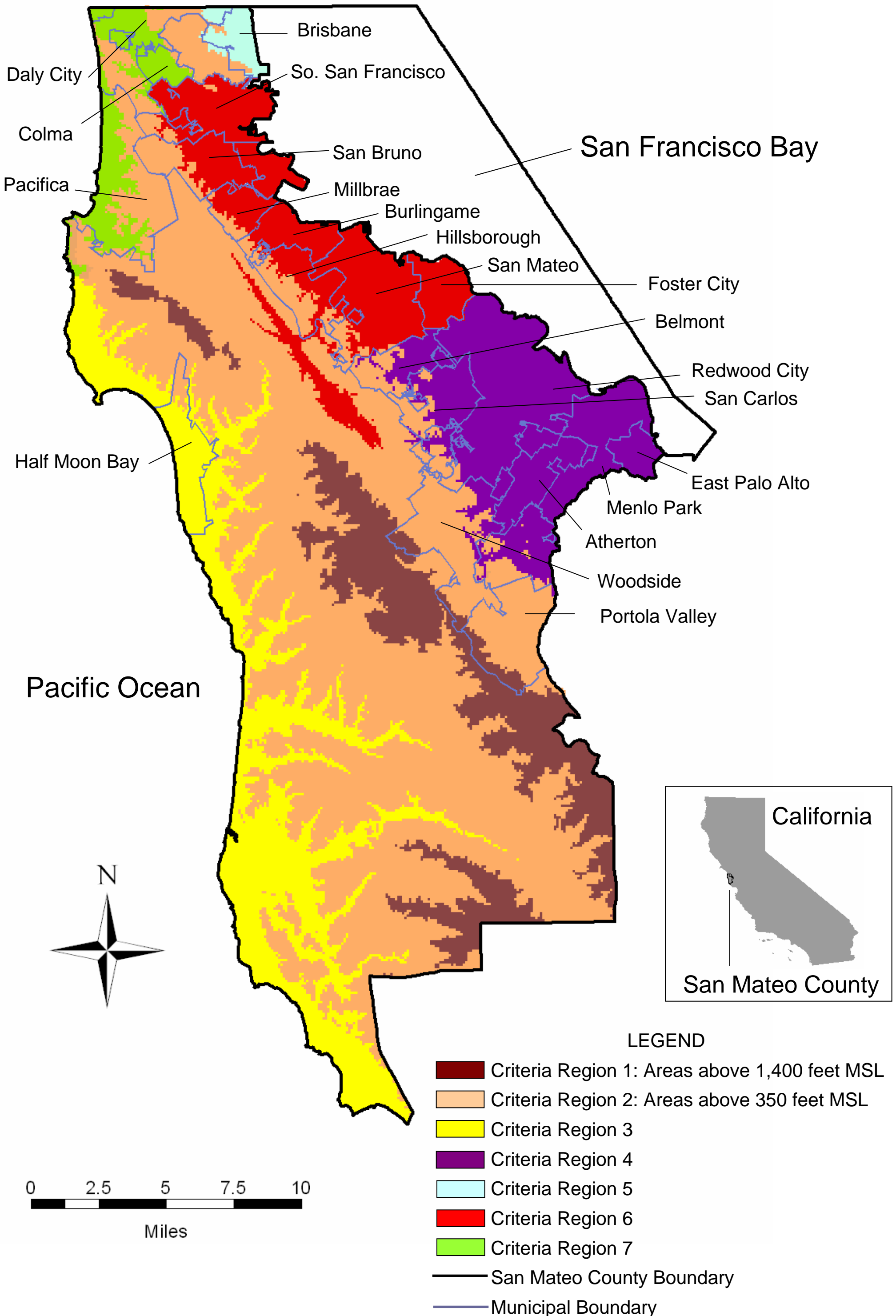
<http://flowstobay.org/newdevelopment>

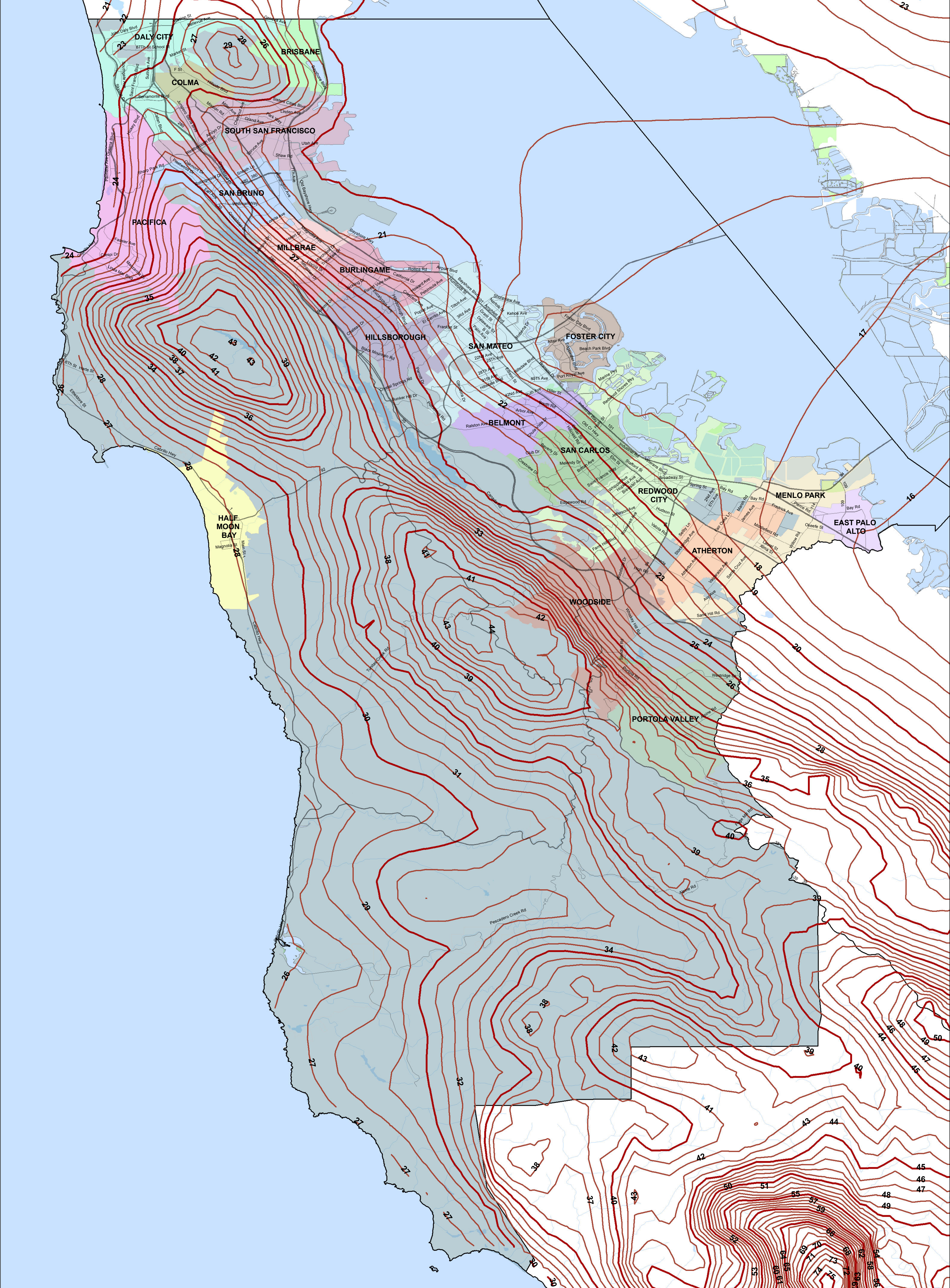
# Appendix C: Treatment Measure Design Criteria Rainfall Regions and Mean Annual Precipitation for San Mateo County

<i>Figure 1. BMP Design Criteria Regions for San Mateo County.....</i>	<i>C-1</i>
<i>Figure 2. San Mateo County Mean Annual Precipitation .....</i>	<i>C-2</i>

# Figure 1

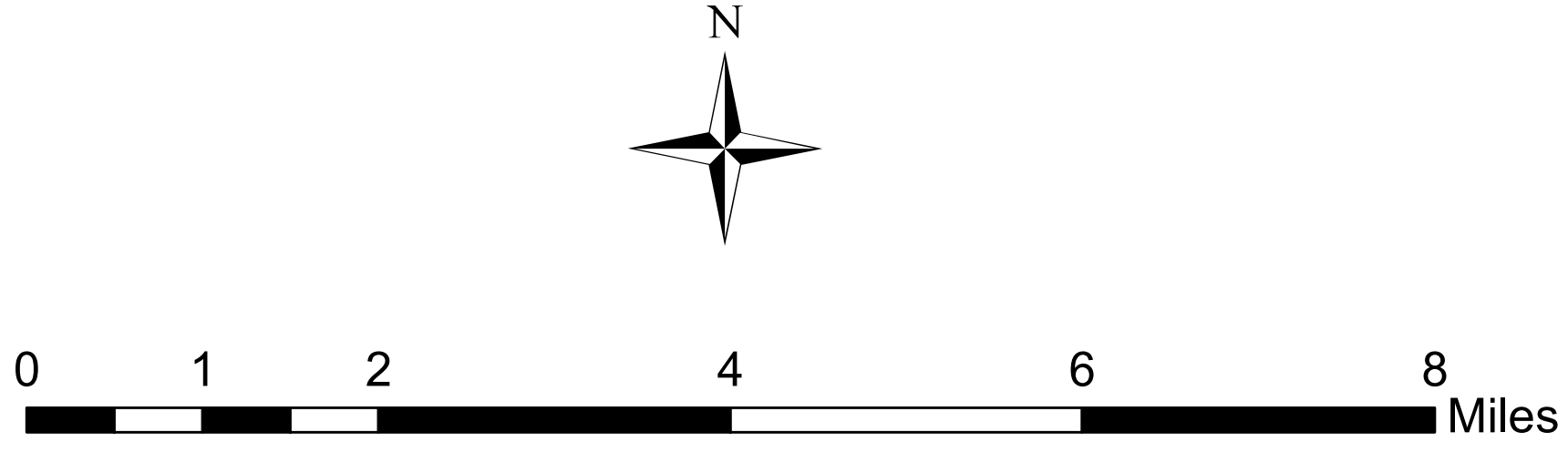
## BMP Design Criteria Regions for San Mateo County





**Figure 2**  
**SAN MATEO COUNTY**  
**MEAN ANNUAL PRECIPITATION**  
 (VALUES IN INCHES)

Precipitation Data Source: PRISM Climate Group,  
 Oregon State University  
 Map Created By: EOA, Inc.  
 Date: June 2013





# Appendix D: Applicability of Inlet Filters, Oil/Water Separators, Hydrodynamic Separators, and Media Filters

<i>Introduction</i> .....	D-1
D.1 <i>Inlet Filters</i> .....	D-2
D.2 <i>Oil/Water Separators</i> .....	D-2
D.3 <i>Hydrodynamic Separators</i> .....	D-3
D.4 <i>Media Filters</i> .....	D-3
D.5 <i>Water Board Staff's Letter</i> .....	D-4

## Introduction

As described in Section 5.2, beginning December 1, 2011, no underground vault systems are allowed for use, except in certain types of “Special Projects,” in which media filters may be allowed. Special Projects criteria are included in Appendix J. Three types of underground systems have been shown to have particular difficulty meeting the NPDES stormwater permit standard of removing pollutants to the maximum extent practicable (MEP). These three systems – inlet filters (also called manufactured drain inserts), oil/water Separators (also called water quality inlets), and hydrodynamic separators – are described below. The Water Board staff’s August 2004 letter that describes issues associated with these treatment measures is included at the end of this Appendix. A discussion of media filters precedes the attached letter.

As described below, some of these devices can be extremely effective in removing trash and other gross solid pollutants, as well as sediment and oil. While not adequate to meet the MEP standard alone, their use may be worth considering if used as part of a treatment train.

### D.1 Inlet Filters

The California Stormwater Quality Association’s (CASQA) New Development BMP Handbook describes storm drain inlet filters (which are also called manufactured drain inserts) as manufactured filters or fabric that are placed in a storm drain inlet to remove sediment and debris. In a letter dated August 5, 2004, the Water Board’s Executive Officer described its assessment of studies and literature reviews for this type of treatment measure. The letter reported that these filters are subject to clogging, have very limited ability to remove dissolved pollutants, need very frequent maintenance, and are likely to receive inadequate maintenance. The following conclusion was made regarding inlet filters:

“Based on our review of these references and experience in the Bay Area, it would be very unlikely for a proposal using inlet filters as the sole treatment measures to meet the MEP standard.”<sup>50</sup>

Based on the Water Board staff’s statements, municipalities may not approve proposals for the use of inlet filters as permanent, post-construction treatment measures on regulated projects, unless they are part of a stormwater “treatment train” approach that includes other, more effective types of stormwater treatment measures. For example, inlet filters may be used as trash capture devices in combination with other treatment systems. See the list of acceptable full trash capture devices on the State Water Board’s website<sup>51</sup>. The use of treatment trains is discussed in Section 5.1.4.

### D.2 Oil/Water Separators

Oil/water separators, also called water quality inlets, are described in CASQA’s New Development BMP Handbook as consisting of one or more chambers that promote sedimentation of coarse materials and

---

<sup>50</sup> Letter from Bruce H. Wolfe, Executive Officer of the San Francisco Bay Regional Water Quality Control Board to the Bay Area Stormwater Management Agencies Association (BASMAA), dated August 5, 2004, [www.cleanwaterprogram.org/uploads/RWQCB\\_letter\\_re\\_inlet\\_filters\\_etc.pdf](http://www.cleanwaterprogram.org/uploads/RWQCB_letter_re_inlet_filters_etc.pdf).

<sup>51</sup> Certified Full Capture Systems, List of Trash Treatment Control Devices, updated by the State Water Board in October 2018: [https://www.waterboards.ca.gov/water\\_issues/programs/stormwater/docs/trash\\_implementation/a1\\_certified\\_fcd.pdf](https://www.waterboards.ca.gov/water_issues/programs/stormwater/docs/trash_implementation/a1_certified_fcd.pdf)

separation of free oil (as opposed to emulsified or dissolved oil). The Water Board’s August 5, 2004, letter described oil/water separators as originally developed for industrial uses and recognized as generally ineffective in removing the types of pollutants normally found in urban stormwater. The letter included the following summary statement regarding oil/water separators:

“With the exception of projects where oil and grease concentrations are expected to be very high, and other measures are included in a ‘treatment train’ approach, Board staff is unlikely to consider oil/water separators as a means of meeting the MEP standard.”

As with inlet filters, based on the Water Board staff’s statements, the municipalities do not approve proposals for the use of oil/water separators to treat stormwater, unless they are used to treat high concentrations of oil and grease and the stormwater receives further treatment for fine-particulates associated with pollutants.

### *D.3 Hydrodynamic Separators*

The US Environmental Protection Agency (USEPA) has described hydrodynamic separators as “flow-through structures with a settling or separation unit to remove sediments”.<sup>52</sup> The energy from the flowing water allows sediments to settle, so no outside power source is needed.

The Contra Costa Clean Water Program conducted a literature review that found that hydrodynamic separators were substantially less effective than various landscape-based treatment measures for removing pollutants that are associated with very fine particles and are identified as pollutants of concern in the Contra Costa Countywide NPDES municipal stormwater permit. Contra Costa’s technical memorandum also described local experience successfully applying a variety of landscape-based treatment measures to development projects in Contra Costa County, as well as operation and maintenance concerns and mosquito generation potential associated with hydrodynamic separators. Effective December 1, 2011, the stand-alone use of hydrodynamic separators is no longer allowed to meet stormwater treatment requirements.

Hydrodynamic separators can be very effective at removing trash and gross solids from runoff, and may be included as part of a treatment train in order to remove large solids before the stormwater is routed to a treatment measure that is more effective at removing fine particulates. Note that HDS units have been approved as trash full capture systems by the State Water Board<sup>53</sup>.

### *D.4 Media Filters*

A technical description of media filters is provided in Section 6.11. Effective December 1, 2011, the stand-alone use of media filters to meet stormwater treatment requirements is no longer allowed, except for use in Special Projects, as described in Appendix J. While media filters have been demonstrated to remove suspended solids more effectively than the manufactured treatment systems described above, concerns remain about the maintenance of these systems. Media filters have more intensive maintenance requirements than low impact development treatment measures, and, since they are located underground,

---

<sup>52</sup> USEPA, Hydrodynamic Separators Fact Sheet, 1999. <https://www.epa.gov/nscep>

<sup>53</sup> Certified Full Capture Systems, List of Trash Treatment Control Devices, updated by the State Water Board in October 2018: [https://www.waterboards.ca.gov/water\\_issues/programs/stormwater/docs/trash\\_implementation/a1\\_certified\\_fcd.pdf](https://www.waterboards.ca.gov/water_issues/programs/stormwater/docs/trash_implementation/a1_certified_fcd.pdf)

tend to be “out of sight, out of mind,” and often do not receive the maintenance required to function properly. When used in Special Projects, it will be important for municipal staff to conduct regular maintenance verification inspections to verify that these systems are maintained properly and operating as designed.

### *D.5 Water Board Staff's Letter*

A copy of the Water Board staff's August 2004 letter discussing the use of inlet filers and oil/water separators is included in the following pages.



# California Regional Water Quality Control Board

## San Francisco Bay Region



**Terry Tamminen**  
Secretary for  
Environmental  
Protection

1515 Clay Street, Suite 1400, Oakland, California 94612  
(510) 622-2300 • Fax (510) 622-2460  
<http://www.swrcb.ca.gov/rwqcb2>

**Arnold Schwarzenegger**  
Governor

Date: August 5, 2004  
File No. 1538.09 (KHL, JBO)

BASMAA Managers  
c/o Geoff Brosseau  
BASMAA Executive Director  
1515 Clay Street,  
Suite 1400  
Oakland, CA 94612

**Subject: Use of Storm Drain Inlet Filters and Oil/Water Separators to Meet the Requirements of NPDES Municipal Stormwater Permits**

Dear BASMAA Managers:

This letter responds to your requests to clarify the Water Board's review of an aspect of municipal stormwater permittee compliance with requirements to include treatment controls in new development and significant redevelopment projects. Please assist us in distribution of this letter to BASMAA member agencies and other interested parties.

The Board regularly receives inquiries regarding the inclusion of stormwater treatment control measures to remove pollutants from new development and redevelopment project runoff. As a state agency, the Board does not endorse specific treatment control products. Also, there is currently no State certification program that would certify the effectiveness of a particular product.

However, the Board's role does include determining permittees' compliance with their NPDES stormwater permits. This includes determining that municipalities have reduced the discharge of pollutants in storm water to the Maximum Extent Practicable (MEP). While not specifically defined within federal clean water law, MEP refers to implementing best management practices (BMPs) that are effective in addressing pollutants, generally accepted by the public, of reasonable cost, and technically feasible.

When reviewing compliance with permit requirements for new development and redevelopment projects, Board staff looks to see that permittees have required projects to incorporate appropriate source controls to prevent the discharge of pollutants, design measures to reduce impervious surface, and treatment controls to remove pollutants from runoff. We review whether these measures have been appropriately designed to be effective, given the existing state

of knowledge. For example, is a vegetated swale designed within parameters specified in existing literature as being effective? Such parameters include minimum residence times, maximum flow depths and velocities, limits on swale longitudinal and side slopes, inclusion of a subdrain if in very tight soils, and similar considerations.

### **Oil/Water Separators**

Another example, vault-based oil-water separators, also known as water quality inlets, was originally designed for industrial use. These have been recognized to be generally ineffective at removing pollutants at concentrations seen in urban stormwater runoff, because removal rates are low and those pollutants that are removed are often flushed out by subsequent storms, especially when a separator is not frequently maintained. With the exception of projects where oil and grease concentrations are expected to be very high, and other controls are included in a “treatment train” approach, Board staff is unlikely to consider oil/water separators as a means of meeting the MEP standard.

### **Storm Drain Inlet Filters**

Storm drain inlet filters, also known as drain inlet inserts, also have been shown to have limited effectiveness in removing pollutants from urban stormwater runoff, due to the nature of their design. Inlet filters are typically either bags or trays of filter media that are designed to catch and treat runoff as it enters the storm drain. They are manufactured stormwater treatment controls, and are typically popular because they have a low capital cost relative to other controls and can be placed into a traditional engineered storm drain design without altering that design.

In determining whether drain inlet filters meet the MEP standard, we reviewed the existing state of knowledge. Board staff’s assessment of studies and literature reviews for this class of controls has found the following:

- Filters are subject to clogging and/or blinding by sediment, trash, and vegetation, resulting in runoff bypassing the filter and/or flooding;
- Maintaining filter performance requires very frequent maintenance (as often as during and after every storm). Manufacturers in practice understate the maintenance requirements for this class of devices. In practice, maintenance is not completed at an effective frequency, particularly to avoid bypass of the filter element clogged with debris;
- Inlet filters, by virtue of their location below a storm drain grate, are out of sight. This can lead to reduced maintenance resulting from the filters being out-of-sight, and thus out-of-mind;
- Filter performance may decay rapidly over a time frame that is significantly shorter than typically recommended replacement or maintenance intervals;
- Filters appear to have very limited ability to remove dissolved pollutants, smaller particulates, and emulsified oil and grease, and may have a limited ability to remove

oil and grease as it is found in urban runoff. The filter element in inlet filters is small and easily bypassed if fouled to prevent flooding.

The limited space within a storm drain inlet appears to preclude highly effective treatment. To the extent that treatment is accomplished, it appears that these controls require an intensive maintenance regime—one that is expensive and which, based on our experience in the Bay Area, is ultimately not completed once the controls have been installed.

A list of references reviewed is attached and includes reports prepared by Bay Area municipal stormwater programs that found the effectiveness of existing inlet filter products to be very limited. Based on our review of these references and experience in the Bay Area, it would be very unlikely for a proposal using inlet filters as the sole treatment measures to meet the MEP standard.

Fortunately, there are a variety of effective controls available to project proponents and designers as alternatives to inlet inserts. These include a range of landscape-based controls (e.g., vegetated swales, bioretention areas, planter/tree boxes, ponds, and stormwater wetlands) and a series of manufactured controls (e.g., vault-based hydrodynamic separators, vault-based media filters, and other solids removal devices). With few exceptions, these controls appear to function more reliably to remove pollutants, and thus would better represent “MEP.”

Each type of BMP should be used in situations for which it is appropriate. For example, the City of Oakland is working to limit trash discharged into Lake Merritt. For that project, controls that primarily remove trash may be most appropriate. For most new development projects, however, BMPs that address the broad spectrum of urban runoff pollutants, from trash to fine particulates and soluble pollutants, are needed.

We recognize that inlet filter products with substantially improved performance may be developed in the future. Also, certification programs like Washington State’s “Evaluation of Emerging Stormwater Treatment Technologies,” which reviews technologies to determine whether they are at least as good as existing non-proprietary measures, may establish viable treatment measures. As with any aspect of the NPDES stormwater program, we anticipate that the municipal stormwater programs and the Board will continue to review information as it is developed so as to best determine what constitutes MEP, and to help ensure the reasonable cost in implementation of effective BMPs.

If you have any questions or further comments, please contact Dale Bowyer at (510) 622-2323 or via email to [dcb@rb2.swrcb.ca.gov](mailto:dcb@rb2.swrcb.ca.gov), or Keith Lichten via email to [khl@rb2.swrcb.ca.gov](mailto:khl@rb2.swrcb.ca.gov), or at (510) 622-2380.

Sincerely,

*--original signed by--*

Bruce H. Wolfe  
Executive Officer

Attachment: References Reviewed



**ATTACHMENT: REFERENCES REVIEWED**

<b>Author</b>	<b>Title</b>	<b>Date</b>	<b>Notes</b>
McDonald, Jonathan / Kristar	Letter & Attachments	September 19, 2003	
Santa Clara Valley Urban Runoff Pollution Prevention Program (SCVURPPP)	Application of Water-Quality Engineering Fundamentals to the Assessment of Stormwater Treatment Devices	August 28, 2002	
SCVURPPP	An Update of the 1999 Catch Basin Retrofit Feasibility Study Technical Memorandum	June 26, 2002	
SCVURPPP	Catch Basin Retrofit Feasibility Study Technical Memorandum	July 12, 1999	
Woodward-Clyde for SCVURPPP	Parking Lot Monitoring Report	June 11, 1996	
Woodward-Clyde for SCVURPPP	Parking Lot BMP Manual	June 11, 1996	
Minton, Gary R./Abtech Industries	Technical Review of the AbTech Ultra-Urban Filter	January 4, 2002	
URS Greiner Woodward Clyde (now URS) / Alameda County Urban Runoff Clean Water Program (now ACCWP)	Stormwater Inlet Insert Devices Literature Review	April 2, 1999	
USEPA/NSF International	ETV Joint Verification Statement: Hydro-Kleen Filtration System	September 2003	
USEPA/NSF International	Environmental Technology Verification Report; In-Drain Treatment Technologies Equipment Verification; Hydro Compliance Management, Inc., Hydro-Kleen Filtration System	September 2003	

Othmer, Friedman, Borroum, and Currier / Caltrans	Performance Evaluation of Structural BMPs: Drain Inlet Inserts (Fossil Filter and StreamGuard) and Oil/Water Separator	2001	
Woodward-Clyde Consultants / Alameda County Urban Runoff Clean Water Program	Street Sweeping/Storm Inlet Modification Literature Review	December 21, 1994	
Woodward-Clyde in association with UCLA and Psomas & Associates.	Santa Monica Bay Municipal Storm Water/Urban Runoff Pilot Project—Evaluation of Potential Catchbasin Retrofits	September 24, 1998	Prepared for Santa Monica Cities Consortium
Interagency Catch Basin Insert Committee	Evaluation of Commercially-Available Catch Basin Inserts for the Treatment of Stormwater Runoff from Developed Sites	October 1995	ICBIC is comprised of: King County Surface Water Mgmt. Div.; King County Dept. of Metropolitan Svcs.; Snohomish County Surface Water Mgmt. Div.; Seattle Drainage and Wastewater Utility; and Port of Seattle.
Caltrans	BMP Retrofit Pilot Program: Final Report (Report ID CTSW-RT-01-050)	January 2004	
Elizabeth Miller Jennings, Senior Staff Counsel, Office of Chief Counsel, State Water Resources Control Board	Memorandum on Maximum Extent Practicable	February 11, 1993	

# Appendix E: Infiltration Guidelines

<i>Introduction</i> .....	<i>E-2</i>
<i>E.1 Stormwater Controls that Promote Infiltration</i> .....	<i>E-2</i>
<i>E.2 Factors Affecting Feasibility of Infiltration</i> .....	<i>E-4</i>
<i>E.3 Dealing with Common Site Constraints</i> .....	<i>E-5</i>
<i>E.4 Infiltration Devices and Class V Injection Well Requirements</i> .....	<i>E-6</i>

## Introduction

As a stormwater management method, infiltration means retaining or detaining water within soils to reduce runoff. Infiltration can be a cost-effective method to manage stormwater – if the conditions on the project site allow. These infiltration guidelines identify categories of stormwater infiltration methods, and describe factors that affect the feasibility of their use.

### E.1 Stormwater Controls that Promote Infiltration

A wide-range of site-design measures and stormwater treatment measures allow stormwater infiltration and can be categorized as described below and illustrated in Figure E-1.

- A. **Site design measures** -- such as clustering development or otherwise laying out the site to reduce impervious area, routing drainage from building roofs to landscaped areas, and using pervious pavement.
- B. **Indirect infiltration methods**, which allow stormwater runoff to percolate into surface soils. The infiltrated water may either percolate down into subsurface soils and eventually reach groundwater, or it may be underdrained into subsurface pipes. Examples of indirect infiltration methods include bioretention areas (formerly described as “vegetated swales” as in Figure E-1 below).
- C. **Direct infiltration methods**, which are designed to bypass surface soils and transmit runoff directly to subsurface soils and eventually groundwater. These devices must be designed with a pretreatment system to limit the potential for groundwater contamination. Examples of direct infiltration methods include infiltration trenches, infiltration basins, and dry wells.
- D.

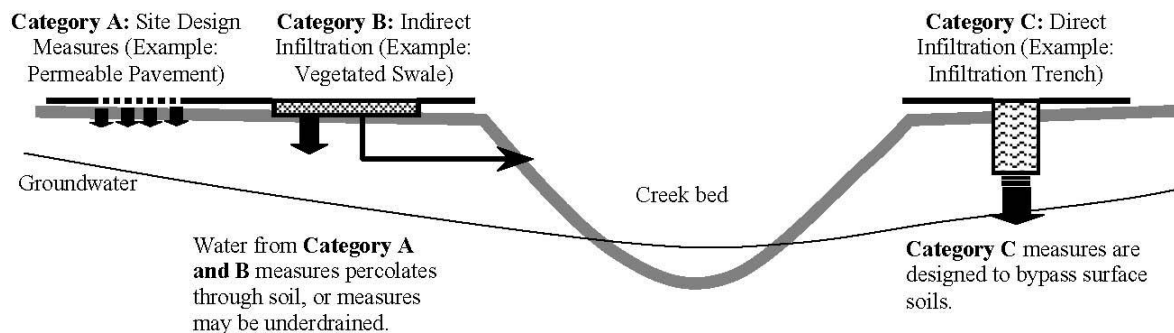


Figure E-1: Stormwater Infiltration Methods (Source: Contra Costa County Clean Water Program, 2005)

Table E-1 describes common stormwater controls and groups them according to whether they meet the above definitions of categories A, B and C. References to the applicable section of Chapter 4 or 6 are given for stormwater controls that have specific technical guidance included in this C3 Guide.

*Table E-1: Infiltration Methods in Commonly-Used Stormwater Controls*

Stormwater Control	Description	Guidance in Section
<b>Category A: Site Design Measures</b>		
<i>Disconnected Downspouts</i>	Instead of connecting directly to storm drains, roof runoff is directed away from the building to nearby landscaped areas.	4.3, 4.6
<i>Site Grading</i>	Using gentler slopes and concave areas to reduce runoff and encourage infiltration.	4.2, 4.3, 4.6
<i>Site Layout Practices</i>	Examples: Use compact, multi-story buildings to reduce building footprint, cluster buildings to reduce street length and protect sensitive areas, design narrow streets, use sidewalks on one side of street.	4.2, GI Design Guide – 3.2
<i>Pavers</i>	Traditional bricks, natural stones or other pavers over a bed of fine crushed aggregate with a reduced load-bearing surface.	4.2, 4.6
<i>Green Roofs</i>	May be “extensive” with a 3-7 inch lightweight substrate and a few types of low-profile plants; or may be “intensive” with a thicker substrate, more varied plantings, and a more garden-like appearance.	4.2, 6.8
<b>Category B: Indirect Infiltration (“Infiltration Measures”)</b>		
<i>Bioretention Area</i>	Briefly ponds stormwater on the surface of a shallow depression and allows it to percolate through permeable soil. Underdrain is typically required, but is elevated to maximize infiltration to underlying soils, where conditions allow.	6.1
<i>Pervious Pavements</i>	Special mixes of concrete and asphalt. Require a base course of crushed aggregate and installation by experienced crews.	6.6
<i>Permeable Paver</i>	A load-bearing, durable surface of impermeable concrete unit pavers separated by joints with crushed aggregate in the joints as well as underneath. A sub-type is constructed of pavers which are themselves permeable and separated by smaller joints with fine aggregate.	6.6
<i>Reinforced Grid Paving</i>	A load-bearing, durable surface of a grid of plastic cells or blocks separated by joints with aggregate or in which soil is planted with turf or other plants.	6.7
<i>Rainwater Harvesting and Use</i>	Rain barrels and cisterns act as storage vessels, sometimes with a manually operated valve, to provide infiltration if runoff is stored for post-storm discharge to landscaping or other infiltration-type systems.	6.9

	<i>Category C: Direct Infiltration (“Infiltration Devices”)</i>	
<i>Infiltration Trench</i>	A trench filled with rock or open graded aggregate.	6.4
<i>Infiltration Basin</i>	An excavation that exposes relatively permeable soils and impounds water for rapid infiltration.	
<i>Dry Well</i>	An excavation, underground storage facility, or drilled shaft filled with open graded aggregate.	
Sources: CCCWP, 2005; CASQA, 2003; ACCWP, 2006; SCVURPPP 2016.		

## E.2 Factors Affecting Feasibility of Infiltration

The Harvest and Use, Infiltration and Evapotranspiration Feasibility/Infeasibility Criteria Report (Feasibility Report) submitted to the Regional Water Board by BASMAA on April 29, 2011, identified the factors listed below that affect the feasibility of infiltration. These factors are grouped according to whether they apply to both indirect and direct infiltration, or whether they apply only to direct infiltration.

As indicated in Table E-1, “*infiltration measures*” are stormwater treatment measures that provide indirect infiltration. Examples of infiltration measures include bioretention areas, self-treating and self-retaining areas and pervious pavement.

“*Infiltration devices*”<sup>54</sup> are designed to bypass surface soils and transmit runoff directly to subsurface soils and eventually groundwater. These types of devices must be located and designed to limit the potential for groundwater contamination and include pretreatment devices for that purpose. Examples of direct infiltration methods include dry wells, injection wells, and infiltration trenches (includes French drains).

Infiltration measures and infiltration devices are referred to collectively as “*infiltration facilities*.”

### E.2.1 Factors Affecting Feasibility of Both Indirect and Direct Infiltration

The following factors are used to determine the feasibility of any infiltration facility, whether it provides indirect infiltration (infiltration measures) or direct infiltration (infiltration devices):

- The permeability of the underlying soil;
- Whether the development site has underlying soil or groundwater contamination;
- Whether the site has potential geotechnical hazards;
- Whether there are conflicts with the location of existing or proposed underground utilities or easements.

<sup>54</sup> The reissued MRP defines “infiltration device” as any structure that is designed to infiltrate stormwater into the subsurface and, as designed, bypass the natural groundwater protection afforded by surface soil.

### E.2.2 Sites Suitable for Direct Infiltration

Factors and design measures that make sites suitable for direct infiltration (infiltration devices) include the following:

- Policies of local water districts or other applicable agencies do not preclude infiltration and there are no known contamination sites.
- A minimum of 100 feet horizontally away from any known water supply wells, septic systems, and underground storage tanks (or greater if the site has highly porous soils or there are other concerns for groundwater protection).
- Vertical distance from the base of any infiltration device to the seasonal high groundwater mark of at least 10 feet (or greater if the site has highly porous soils or there are other concerns for groundwater protection);
- Appropriate pollution prevention and source control measures, including a minimum of two feet of suitable soil to achieve a maximum of 5 inches/hour infiltration rate (or an equivalent pretreatment system to remove pollutants that could affect groundwater quality); and
- Adequate maintenance practices provided to minimize risk to groundwater quality and maximize pollutant removal capabilities;

Unless stormwater is first treated by a method other than infiltration, infiltration devices are not allowed to be used as a treatment measure for stormwater runoff from areas of industrial areas, areas of high vehicular traffic or land uses that pose a high threat to water quality;

## E.3 Dealing with Common Site Constraints

The following tips are intended to help manage constraints to infiltration that are common in San Mateo County.

- Where infiltration of the C.3.d amount of runoff is infeasible, bioinfiltration or bioretention areas may be used if drainage is sufficient or underdrains are provided. The design should maximize infiltration to the underlying soil, as shown in Section 6.1. Some indirect infiltration to groundwater will occur and will enhance the effectiveness of these treatment measures. Site design measures such as disconnected downspouts and pervious paving may be used if soils are amended and positively drained.
- Infiltration is generally infeasible on steep or unstable slopes. Site design measures that limit impervious area may be appropriate if approved by a geotechnical engineer. Consider detaining runoff in green roofs and cisterns, or using stormwater treatment measures that do not infiltrate water into the natural ground, such as flow-through planters or tree well filters.
- Green roofs, cisterns, flow-through planters, lined tree well filters, and other stormwater controls that are isolated from underlying soils are also appropriate for areas with high ground water and/or groundwater contamination.
- A variety of site design measures can often be used even on sites with the constraints described above, including (but not limited to) amended soils, structural soils, grading

landscaping to a concave form, designing taller buildings with smaller footprints, and concentrating development on less sensitive portions of the site.

### *E.4 Infiltration Devices and Class V Injection Well Requirements*

In order to protect underground sources of drinking water, the USEPA regulates some infiltration devices as Class V wells under its Underground Injection Control (UIC) Program. A **Class V injection well** is defined as "... any bored, drilled, or driven shaft, or dug hole that is deeper than its widest surface dimension, or an improved sinkhole, or a subsurface fluid distribution system."<sup>55</sup> Infiltration trenches are typically not considered Class V injection wells because they are longer than they are wide. The USEPA's regulations state that stormwater drainage wells are "authorized by rule" (40 CFR 144), which means they do not require a permit from USEPA if they do not endanger underground sources of drinking water, and they comply with federal UIC requirements. (However, a permit may be required from San Mateo County Environmental Health – see box below.) For more information, see the USEPA's fact sheet, "When Are Storm Water Discharges Regulated as Class V Wells?" is included at the end of this appendix.

If the project includes one or more infiltration devices that are regulated as Class V injection wells, then basic inventory information about the device(s) will need to be submitted to the regional office of the USEPA. Instructions for submitting this information are available on the USEPA Region 9 website at <https://www.epa.gov/uic/underground-injection-control-regulations-and-safe-drinking-water-act-provisions>. Project sponsors are responsible for constructing, operating and closing the drainage well in a manner that does not risk contaminating underground sources of drinking water. The USEPA may place additional requirements on the infiltration device. Project sponsors should contact the appropriate USEPA staff, identified on the Internet link provided above, to learn what inventory information should be submitted, and when the submittal should be made.

In San Mateo County, the County Environmental Health Department issues well installation permits (except for the City of Daly City, which has local permitting authority). If a dry well or injection well depth exceeds 10 feet or if groundwater is encountered when installing the well, the well is required to be permitted by County Environmental Health. The requirement for a minimum 10-foot separation between the bottom of the well and seasonal high groundwater also applies. For more information, see: <https://www.smchealth.org/gpp>

---

<sup>55</sup> USEPA Office of Ground Water and Drinking Water, "When Are Storm Water Discharges Regulated as Class V Wells?" June 2003.



# Appendix F: Mosquito Control Guidelines

<i>F.1 Design Guidance for Mosquito Control.....</i>	<i>F-2</i>
<i>F.2 Maintenance Guidance for Mosquito Control .....</i>	<i>F-6</i>

This appendix presents guidance from the Countywide Program’s Vector Control Plan for designing and maintaining stormwater treatment measures to control mosquitoes. Project sponsors are responsible for incorporating in their treatment measure designs and maintenance plans the design and maintenance guidance, presented below. Project plans that include stormwater treatment measures (and their maintenance plans) will be routed by the municipality to the San Mateo County Mosquito Abatement District (SMCMAD) for review. Project applicants may wish to consult with SMCMAD staff for guidance at (650) 344-8592.

### *F.1 Design Guidance for Mosquito Control*

The following design considerations were adapted from guidance prepared by the California Department of Health Services,<sup>56</sup> and are provided for project sponsors to use when selecting, designing, and constructing stormwater treatment measures.

#### General Design Principles

- Preserve natural drainage. Use site design measures to reduce the amount of stormwater runoff and provide for natural on-site runoff control. This will reduce the number of treatment measures required.
- In flat areas, where standing water may occur for more than 72 hours under existing conditions, consider grading to make minor increases in slope to improve surface drainage and prevent standing water.
- Select stormwater management measures based on site-specific conditions. Designs that take into account site conditions tend to improve drainage and limit the occurrence of stagnant water.
- Attend to ponds that temporarily impound water. Careful consideration should be made before intermittently flooded stormwater treatment measures are selected for handling stormwater. Facilities that pond water for an extended period (e.g., extended detention basins and constructed wetlands) must be designed to drain water completely within 72 hours of a storm event. Avoid placement of extended detention basins and underground structures in areas where they are likely to remain wet (i.e., high water tables). The principal outlet should have positive drainage.
- When a new stormwater treatment measure is being installed, a selection of a type that does not require a wet pond or other permanent pool of water should be considered.
- Properly design storm drain systems. The sheltered environment inside storm drains can promote mosquito breeding. Pipes should be designed and constructed for a rate of flow that flushes the system of sediment and prevents water backing up in the pipe. Storm drains should be constructed so that the invert out is at the same elevation as the interior bottom to prevent standing water.
- Use grouted rock energy dissipaters instead of loose rock.
- In practice, many stormwater treatment measures, not only wet ponds, hold water for over 72 hours, sometimes due to their outdated designs, and possibly due to improper construction and

---

<sup>56</sup> Metzger, Marco, Vector-Borne Disease Section, California Department of Health Services. “Managing Mosquitoes in Stormwater Treatment Devices,” 2004.

maintenance. To ensure that public health and safety are maintained, the following suggestions should be considered for any structure that holds water for over 72 hours:

- Select or design an alternative (or modified) device that provides adequate -pollutant removal and complete drainage in 72 hours. This is the most reliable and cost-effective choice.
- Contact state or local public health or vector control agencies to determine whether local mosquito species and local factors may preclude rapid mosquito emergence, thus safely allowing water residence times to exceed 72 hours. In some areas this may require a detailed study that should be funded by the soliciting party.
- Provide adequate funds necessary to support routine mosquito monitoring and control and maintenance.
- Per the Vector Control Plan, project plans that include stormwater treatment measures (and their maintenance plans), will be routed to the San Mateo County Mosquito Abatement District for review. Project applicants may wish to consult with Mosquito Abatement District staff for guidance.

### General Access Requirements for Mosquito Control

The following requirements are necessary to provide mosquito abatement personnel access to treatment measures for inspection and abatement activities.

- Design stormwater treatment devices to be easily and safely accessible without the need for special requirements (e.g., OSHA requirements for “confined space”).
- If utilizing covers, include in the design spring-loaded or light-weight access hatches that can be opened easily for inspection.
- Provide all-weather road access (with provisions for turning a full-size work vehicle) along at least one side of large above-ground structures that are less than 25 feet wide. For structures that have shoreline-to-shoreline distances in excess of 25 feet, a perimeter road is required for access to all sides.

### Dry System Design Principles for Mosquito Control

- Design structures so they do not hold standing water for more than 72 hours.
- Incorporate features that prevent or reduce the possibility of clogged discharge orifices (e.g., debris screens). The use of weep holes is not recommended due to rapid clogging - except in bubble-up inlet systems.
- Use the hydraulic grade line of the site to select a treatment measure that allows water to flow by gravity through the structure. Pumps are not recommended because they are subject to failure and often require sumps that hold water.
- Design distribution piping and containment basins with adequate slopes to drain fully and prevent standing water. The design slope should take into consideration buildup of sediment between maintenance periods. Compaction during grading may also be needed to avoid slumping and settling.
- Avoid the use of loose riprap or concrete depressions that may hold standing water.
- Avoid barriers, diversions, or flow spreaders that may retain standing water.

- Use mosquito net to cover sand media filter pump sumps.
- Use aluminum “smoke proof” covers for any vault sedimentation basins.
- Properly design storm drain systems. The sheltered environment inside storm drains can promote mosquito breeding. Pipes should be designed and constructed for a rate of flow that flushes the system of sediment and prevents water backing up in the pipe.

### Sumps, Wet Vaults, and Catch Basin Design Principles for Mosquito Control

- Completely seal structures that retain water permanently or longer than 72 hours to prevent entry of adult mosquitoes. Adult female mosquitoes may penetrate openings as small as 1/16 inch (2 mm) to gain access to water for egg laying. Screening (24 mesh screens) can exclude mosquitoes, but it is subject to damage and is not a method of choice.
- If covers are used, they should be tight fitting with maximum allowable gaps or holes of 1/16 inch (2 mm) to exclude entry of adult mosquitoes. Gaskets are a more effective barrier when used properly.
- Any covers or openings to enclosed areas where stagnant water may pool must be large enough (2 feet by 3 feet) to permit access by vector control personnel for surveillance and, if necessary, abatement activities.
- If the sump, vault, or basin is sealed against mosquitoes, with the exception of the inlet and outlet, use a design that will submerge the inlet and outlet completely to reduce the available surface area of water for mosquito egg-laying (female mosquitoes can fly through pipes).
- Creative use of flapper or pinch valves, collapsible tubes and “brush curtains” may be effective for mosquito exclusion in certain designs.
- Design structures with the appropriate pumping, piping, valves, or other necessary equipment to allow for easy dewatering of the unit, if necessary.

### Wet Ponds and Wetlands Design Principles for Mosquito Control

- If a wet pond or constructed, modified, or restored wetland must be built, appropriate and adequate funds must be allocated to support long-term site maintenance as well as routine monitoring and management of mosquitoes by a qualified agency.
- Before approving a wet pond or wetland system, evaluate the long-term costs and jurisdictional and maintenance issues associated with the potential establishment of special-status species. If any doubt exists, consider alternate stormwater treatment measures.
- Long-term management of mosquitoes in wet ponds and wetlands should integrate biological control, vegetation management and other physical practices, and chemical control as appropriate.
- Provide for regular inspection of sites for detection of developing mosquito populations. Local factors may influence the overall effectiveness of certain approaches for mosquito reduction.
- Wet ponds and wetlands should maintain water quality sufficient to support surface-feeding fish such as mosquito fish (*Gambusia affinis*), which feed on immature mosquitoes and can aid significantly in mosquito control.

## F.1 Design Guidance for Mosquito Control

- If large predatory fish are present (e.g., perch and bass), mosquito fish populations may be negatively impacted or eradicated. In this case, careful vegetation management remains the only nonchemical mosquito control measure.
- Where mosquito fish are not allowed, careful vegetation management remains the only nonchemical mosquito control measure. Other predators such as dragonflies, diving beetles, birds, and bats feed on mosquitoes when available, but their effects are generally insufficient to preclude chemical treatment.
- Perform routine maintenance to reduce emergent plant densities. Emergent vegetation provides mosquito larvae with refuge from predators, protection from surface disturbances, and increased nutrient availability while interfering with monitoring and control efforts.
- Whenever possible, maintain wet ponds and wetlands at depths in excess of 4 feet to limit the spread of invasive emergent vegetation such as cattails (*Typha* spp.). Deep, open areas of exposed water are typically unsuitable for mosquito immatures due to surface disturbances and predation. Deep zones also provide refuge areas for fish and beneficial macroinvertebrates should the densely vegetated emergent zones be drained.
- Build shoreline perimeters as steep and uniform as practicable to discourage dense plant growth.
- Use concrete or liners in shallow areas to discourage unwanted plant growth where vegetation is unnecessary.
- Eliminate floating vegetation conducive to mosquito production, such as water hyacinth (*Eichhornia* spp.), duckweed (*Lemna* and *Spirodela* spp.), and filamentous algal mats.
- Make shorelines accessible to maintenance and vector control crews for periodic maintenance, control, and removal of emergent vegetation, as well as for routine mosquito monitoring and abatement procedures, if necessary.
- Design and obtain necessary approvals for all wet ponds and wetlands to allow for complete draining when needed.
- Improve designs of permanent pools. Minimize shallow depths and increase circulation in ponds. Do not plant dense stands of vegetation that impede flow circulation. Permanently flooded systems should be stocked with native *Gambusia* minnows to foster biological predation on mosquito larvae.
- Do not use stormwater structures to meet endangered species mitigation requirements. Aquatic habitat for endangered species should not be created near areas populated by humans.

### F.2 Maintenance Guidance for Mosquito Control

Routine and timely maintenance is critical for suppressing mosquito breeding as well as for meeting local water quality goals. If maintenance is neglected or inappropriate for a given site, even structures designed to be the least “mosquito friendly” may become significant breeding sites. Although general principles of vector control are described here, maintenance guidelines for individual treatment measures are often site-specific.

The maintenance principles given below are intended to reduce the mosquito population. These principles should be incorporated, as appropriate, in maintenance plans developed for stormwater treatment control measures and in the ongoing maintenance and inspection of treatment measures.

#### General Maintenance Principles

- Minimize stagnant water (i.e., maintain constant exchange of water in systems). See **section 6.2 of the GI Design Guide** for more guidance on standing water.
- Minimize surface area (i.e., deeper water habitat is preferable).
- With the exception of certain treatment measures designed to hold permanent water, all treatment measures should drain completely within 72 hours to effectively suppress vector production.
- Build perimeter access roads or trails to access wet ponds. Without proper access avenues, the “barbed wire” effect can result where sharp vines prevent vector monitoring and abatement.
- Site inspections of newly constructed projects should be routinely conducted by municipalities to avoid the inadvertent approval of improperly constructed systems.
- Any circumstances that restrict the flow of water from a system as designed should be corrected. Debris or silt build-up obstructing an outfall structure should be removed. Under drains and filtration media should be inspected periodically and cleaned out or replaced as needed.
- Conduct maintenance activities regularly, in accordance with a municipality-approved maintenance plan.

#### Vegetation Management Maintenance Principles

- Conduct annual vegetative management, such as removing weeds and restricting growth of aquatic vegetation to the periphery of wet ponds.
- Remove grass cuttings (unless using a mulching mower), trash and other debris, especially at outlet structures
- Avoid producing ruts when mowing (water may pool in ruts).

#### Dry System Maintenance Principles for Mosquito Control

- Extended detention basins are usually designed to detain water for periods less than 72 hours. If they detain water for longer than five days, they are poorly maintained.
- If a detention basin has been installed at an inappropriate location (e.g., on a site where the water table is too close to the surface), if elimination of the system isn’t possible then mosquitoes must

be controlled with larvicides. The larvicide operation, in order to be effective, must be supported by a quality inspection program.

### Underground Structure Maintenance Principles for Mosquito Control

- Prevent mosquito access to underground systems that may have standing water (i.e., seal openings that are 1/16-inch in diameter or greater).
- Provide SMCMAAD access to underground systems that may have standing water.

### Infiltration and Filtration Device Maintenance Principles for Mosquito Control

- Infiltration trenches and sand filter structures should not hold water for longer than 24 hours. If they retain water for longer than 48 hours, they are poorly maintained.

# Appendix G: Operation and Maintenance Document Templates

Example templates are provided to assist project applicants in preparing the following documents, which municipalities may require as exhibits to a stormwater treatment measure maintenance agreement:

- G1 Standard Treatment Measure O&M Report Form*
- G2 Maintenance Plan for Bioretention Area (includes bioinfiltration area)*
- G3 Maintenance Plan for Flow-through Planter*
- G4 Maintenance Plan for Tree Well Filter*
- G5 Maintenance Plan for Infiltration Trench*
- G6 Maintenance Plan for Extended Detention Basin*
- G7 Maintenance Plan for Pervious Pavement*
- G8 Maintenance Plan for Media Filter*
- G9 Maintenance Plan for Rainwater Harvesting*

Requirements vary from one municipality to the next. Contact the local jurisdiction to obtain electronic files for use in preparing these documents, and to obtain information on municipality-specific requirements.



**Stormwater Treatment Measure Operation and Maintenance  
Inspection Report to the [[== Insert Name of Municipality==]], California**

This report and attached Inspection and Maintenance Checklists document the inspection and maintenance conducted for the identified stormwater treatment measure(s) subject to the Maintenance Agreement between the City and the property owner during the annual reporting period indicated below.

**I. Property Information:**

Property Address or APN: \_\_\_\_\_

Property Owner: \_\_\_\_\_

**II. Contact Information:**

Name of person to contact regarding this report: \_\_\_\_\_

Phone number of contact person: \_\_\_\_\_ Email: \_\_\_\_\_

Address to which correspondence regarding this report should be directed:  
\_\_\_\_\_  
\_\_\_\_\_

**III. Reporting Period:**

This report, with the attached completed inspection checklists, documents the inspections and maintenance of the identified treatment measures during the time period from \_\_\_\_\_ to \_\_\_\_\_.

**IV. Stormwater Treatment Measure Information:**

The following stormwater treatment measures (identified treatment measures) are located on the property identified above and are subject to the Maintenance Agreement:

Identifying Number of Treatment Measure	Type of Treatment Measure	Location of Treatment Measure on the Property

**V. Summary of Inspections and Maintenance:**

Summarize the following information using the attached Inspection and Maintenance Checklists:

Identifying Number of Treatment Measure	Date of Inspection	Operation and Maintenance Activities Performed and Date(s) Conducted	Additional Comments

**VI. Sediment Removal:**

Total amount of accumulated sediment removed from the stormwater treatment measure(s) during the reporting period: \_\_\_\_\_ cubic yards.

How was sediment disposed?

- landfill
- other location on-site as described in and allowed by the maintenance plan
- other, explain \_\_\_\_\_

**VII. Inspector Information:**

The inspections documented in the attached Inspection and Maintenance Checklists were conducted by the following inspector(s):

Inspector Name and Title	Inspector's Employer and Address

**VIII. Certification:**

I hereby certify, under penalty of perjury, that the information presented in this report and attachments is true and complete:

\_\_\_\_\_  
Signature of Property Owner or Other Responsible Party

\_\_\_\_\_  
Date

\_\_\_\_\_  
Type or Print Name

\_\_\_\_\_  
Company Name

\_\_\_\_\_  
Address

Phone number: \_\_\_\_\_ Email: \_\_\_\_\_

**Bioretention Area<sup>1</sup> Maintenance Plan for  
[[= Insert Project Name =]]**

[[= Insert Date =]]



*Bioretention areas function as soil and plant-based filtration devices that remove pollutants through a variety of physical, biological, and chemical treatment processes. These facilities normally consist of a ponding area, mulch layer, vegetation and biotreatment soil mix.*

Project Address and Cross Streets

\_\_\_\_\_

\_\_\_\_\_

Assessor's Parcel No. \_\_\_\_\_

Property Owner: \_\_\_\_\_

Phone No.: \_\_\_\_\_

Designated Contact: \_\_\_\_\_

Phone No.: \_\_\_\_\_

Mailing Address: \_\_\_\_\_

The property contains [[= insert number =]] bioretention area(s), located as described below and as shown in the attached site plan<sup>2</sup>.

- **Bioretention Area No. 1** is located at [[= describe location =]].
- [[= Add descriptions of other bioretention areas, if applicable. =]]

**I. Routine Maintenance Activities**

The principal maintenance objective is to prevent sediment buildup and clogging, which reduces pollutant removal efficiency and may lead to bioretention area failure. Routine maintenance activities, and the frequency at which they will be conducted, are shown in Table 1.

Table 1 Routine Maintenance Activities for Bioretention Areas		
No.	Maintenance Task	Frequency of Task
1	Remove obstructions, accumulated sediment, debris and trash from bioretention area and dispose of properly.	Monthly, or as needed after storm events
2	Inspect bioretention area to ensure that it drains between storms and within five days after rainfall. If ponded water does not drain within five days, check if drains are clogged or consider removing the surface biotreatment soil media and replacing with the approved soil media, plants and mulch. <sup>3</sup>	Monthly, or as needed after storm events

<sup>1</sup> Bioretention areas include linear treatment measures designed to filter water through biotreatment soil media. A bioretention area that has no waterproof liner beneath it and has a raised underdrain in the underlying rock layer to promote infiltration, as shown in Section 6.1 of the C.3 Regulated Projects Guide, may also be called a "bioinfiltration area".

<sup>2</sup> Attached site plan must match the site plan exhibit to Maintenance Agreement.

<sup>3</sup> Plant lists, Specifications for Biotreatment Soil Media and Mulch and Supplier lists can be found here:  
[www.flowstobay.org/preventing-stormwater-pollution/with-new-redevelopment/c-3-regulated-projects/](http://www.flowstobay.org/preventing-stormwater-pollution/with-new-redevelopment/c-3-regulated-projects/)

<b>Table 1</b> <b>Routine Maintenance Activities for Bioretention Areas</b>		
3	Inspect inlets for channels, soil exposure or other evidence of erosion. Clear obstructions and remove sediment.	Monthly, or as needed after storm events
4	Evaluate health of trees, shrubs and small plants. Remove and replace all dead and diseased vegetation. <sup>3</sup>	Twice a year
5	Maintain vegetation and the irrigation system. Prune and weed to keep bioretention area neat and orderly in appearance.	Before wet season begins, or as needed
6	Inspect and, if needed, add mulch before the wet season begins. It is recommended that composted arbor mulch be applied once a year to maintain a 3" depth of mulch over all bare soil areas except within six inches of tree trunks. <sup>3</sup>	Before wet season begins, or as needed
7	Inspect bioretention area using the attached inspection checklist.	Monthly, or after large storm events, and after removal of accumulated debris or material

**II. Prohibitions**

Do not use pesticides or other chemical applications to treat diseased plants, control weeds or removed unwanted growth. Employ non-chemical controls (biological, physical and cultural controls) to treat a pest problem. Prune plants properly and at the appropriate time of year. Provide adequate irrigation for landscape plants. Do not over water.

**III. Mosquito Abatement**

Standing water should not remain in the treatment measures for more than five days, to prevent mosquito generation. Should any mosquito issues arise, contact the San Mateo County Mosquito and Vector Control District (SMCMVCD), as needed for assistance. Mosquito larvicides should be applied only when absolutely necessary, as indicated by the SMCMVCD, and then only by a licensed professional or contractor. Contact information for SMCMVCD is provided below.

San Mateo County Mosquito Vector Control District  
 1351 Rollins Road  
 Burlingame, CA 94010  
 PH: (650) 344-8592  
 FAX: (650) 344-3843  
[Email: info@smcmvcd.org](mailto:info@smcmvcd.org)

**IV. Inspections**

The attached Bioretention Area Inspection and Maintenance Checklist should be used to conduct inspections monthly (or as needed), identify needed maintenance, and record maintenance that is conducted.

## Bioretention Area Inspection and Maintenance Checklist

Property Address: \_\_\_\_\_

Property Owner: \_\_\_\_\_

Treatment Measure No.: \_\_\_\_\_ Date of Inspection: \_\_\_\_\_ Type of Inspection:  Monthly  Pre-Wet Season

After heavy runoff  End of Wet Season

Inspector(s): \_\_\_\_\_

Other: \_\_\_\_\_

Defect	Conditions When Maintenance Is Needed	Maintenance Needed? (Y/N)	Comments (Describe maintenance completed and if needed maintenance was not conducted, note when it will be done)	Results Expected When Maintenance Is Performed
1. Standing Water	When water stands in the bioretention area between storms and does not drain within five days after rainfall.			There should be no areas of standing water once inflow has ceased. Any of the following may apply: sediment or trash blockages removed, improved grade from head to foot of bioretention area, or added underdrains.
2. Trash and Debris Accumulation	Trash and debris accumulated in the bioretention area.			Trash and debris removed from bioretention area and disposed of properly.
3. Sediment	Evidence of sedimentation in bioretention area.			Material removed so that there is no clogging or blockage. Material is disposed of properly.
4. Erosion	Channels have formed around inlets, there are areas of bare soil, and/or other evidence of erosion.			Obstructions and sediment removed so that water flows freely and disperses over a wide area. Obstructions and sediment are disposed of properly.
5. Vegetation	Vegetation is dead, diseased and/or overgrown.			Vegetation is healthy and attractive in appearance.
6. Mulch	Mulch is missing or patchy in appearance. Areas of bare earth are exposed, or mulch layer is less than 3 inches in depth.			All bare earth is covered, except mulch is kept 6 inches away from trunks of trees and shrubs. Mulch is even in appearance, at a depth of 3 inches.
7. Miscellaneous	Any condition not covered above that needs attention in order for the bioretention area to function as designed.			Meet the design specifications.

**Flow-Through Planter Maintenance Plan for**  
**[[= Insert Project Name =]]**  
 [[= Insert Date =]]



*Flow-through planters are designed to treat and temporarily detain runoff without allowing seepage into the underlying soil. They typically receive runoff via downspouts leading from the roofs of adjacent buildings.*

Project Address and Cross Streets

\_\_\_\_\_

\_\_\_\_\_

Assessor's Parcel No. \_\_\_\_\_

Property Owner: \_\_\_\_\_

Phone No.: \_\_\_\_\_

Designated Contact: \_\_\_\_\_

Phone No.: \_\_\_\_\_

Mailing Address: \_\_\_\_\_

The property contains [[= insert number =]] flow-through planter(s), located as described below and as shown in the attached site plan<sup>1</sup>:

- **Flow-Through Planter No. 1** is located at [[= describe location =]].
- [[= Add descriptions of other flow-through planters, if applicable. =]]

**I. Routine Maintenance Activities**

The principal maintenance objectives are to ensure that water flows unimpeded into the flow-through planter and landscaping remains attractive in appearance. Table 1 shows the routine maintenance activities, and the frequency at which they will be conducted.

<b>Table 1</b>		
<b>Routine Maintenance Activities for Flow-Through Planters</b>		
<b>No.</b>	<b>Maintenance Task</b>	<b>Frequency of Task</b>
1	Evaluate health of trees, shrubs and small plants. Remove and replace all dead and diseased vegetation. <sup>2</sup>	Twice a year
2	Maintain vegetation and the irrigation system. Prune and weed to keep flow-through planter neat and orderly in appearance.	As needed
3	Check that mulch is 3" deep and replenish as necessary. It is recommended that composted arbor mulch be applied once per year to maintain the 3" depth in all bare soil areas except within six inches of tree trunks. <sup>2</sup>	Before wet season and as needed

<sup>1</sup> Attached site plan must match the site plan exhibit to Maintenance Agreement.

<sup>2</sup> Plant lists, Specifications for Biotreatment Soil Media and Mulch and Supplier lists, can be found here: [www.flowstobay.org/preventing-stormwater-pollution/with-new-redevelopment/c-3-regulated-projects/](http://www.flowstobay.org/preventing-stormwater-pollution/with-new-redevelopment/c-3-regulated-projects/)

<b>Table 1</b> <b>Routine Maintenance Activities for Flow-Through Planters</b>		
4	Check that soil is at appropriate depth. Till or replace soil with the approved biotreatment soil media as necessary to maintain a minimum of 6 inches between the top of the biotreatment soil media and overflow outlet. <sup>2</sup>	Before wet season and as necessary
5	Remove obstructions, accumulated sediment, litter/trash and debris and dispose of properly. Confirm that no clogging will occur and that planter will drain within one day.	Before wet season and as necessary
6	Inspect flow-through planter to ensure that there are no clogs. Test with garden hose to confirm that the planter will drain within three to four hours.	Before wet season and after large storm events
7	Inspect downspouts from rooftops and sheet flow from paved areas to ensure flow to planter box is unimpeded. Remove debris and repair damaged pipes. Check splash blocks or rocks and repair, replace and replenish as necessary.	Monthly during the wet season, and as needed after storm events
8	Inspect overflow pipe to ensure that it will safely convey excess flows to storm drain. Repair or replace any damaged or disconnected piping.	Before the wet season, and as necessary
9	Inspect flow-through planter to ensure that box is structurally sound (no cracks or leaks). Repair as necessary.	Annually
10	Inspect flow-through planter using the attached inspection checklist.	Monthly, or after large storm events, and after removal of accumulated debris or material

**II. Prohibitions**

Do not use pesticides or other chemical applications to treat diseased plants, control weeds or removed unwanted growth. Employ non-chemical controls (biological, physical and cultural controls) to treat a pest problem. Prune plants properly and at the appropriate time of year. Provide adequate irrigation for landscape plants. Do not over water.

**III. Mosquito Abatement**

Standing water shall not remain in the treatment measures for more than five days, to prevent mosquito generation. Should any mosquito issues arise, contact the San Mateo County Mosquito and Vector Control District (SMCMVCD), as needed for assistance. Mosquito larvicides shall be applied only when absolutely necessary, as indicated by the SMCMVCD, and then only by a licensed professional or contractor. Contact information for SMCMVCD is provided below.

San Mateo County Mosquito Abatement District  
 1351 Rollins Road  
 Burlingame, CA 94010  
 PH: (650) 344-8592  
 FAX: (650) 344-3843  
[Email: info@smcmvcd.org](mailto:info@smcmvcd.org)

**IV. Inspections**

The attached Flow-Through Planter Inspection and Maintenance Checklist shall be used to conduct inspections monthly (or as needed), identify needed maintenance, and record maintenance that is conducted.



## Flow-Through Planter Inspection and Maintenance Checklist

Property Address: \_\_\_\_\_

Property Owner: \_\_\_\_\_

Treatment Measure No.: \_\_\_\_\_ Date of Inspection: \_\_\_\_\_ Type of Inspection:  Monthly  Pre-Wet Season  
 After heavy runoff  End of Wet Season  
 Other: \_\_\_\_\_

Inspector(s): \_\_\_\_\_

Defect	Conditions When Maintenance Is Needed	Maintenance Needed? (Y/N)	Comments (Describe maintenance completed and if needed maintenance was not conducted, note when it will be done)	Results Expected When Maintenance Is Performed
1. Vegetation	Vegetation is dead, diseased and/or overgrown.			Vegetation is healthy and attractive in appearance.
2. Soil	Soil too deep or too shallow.			Soil is at proper depth (per soil specifications) for optimum filtration and flow.
3. Mulch	Mulch is missing or patchy in appearance. Areas of bare earth are exposed, or mulch layer is less than 3 inches in depth.			All bare earth is covered, except mulch is kept 6 inches away from trunks of trees and shrubs. Mulch is even in appearance, at a depth of 3 inches.
4. Sediment, Trash and Debris Accumulation	Sediment, trash and debris accumulated in the flow-through planter. Planter does not drain as specified.			Sediment, trash and debris removed from flow-through planter and disposed of properly. Planter drains within 3-4 hours.
5. Clogs	Soil too deep or too shallow. Sediment, trash and debris accumulated in the flow-through planter. Planter does not drain within three days after rainfall.			Planter drains per design specifications.
6. Downspouts and Sheet Flow	Flow to planter is impeded. Downspouts are clogged or pipes are damaged. Splash blocks and rocks in need of repair, replacement or replenishment.			Downspouts and sheet flow is conveyed efficiently to the planter.
7. Overflow Pipe	Does not safely convey excess flows to storm drain. Piping damaged or disconnected.			Overflow pipe conveys excess flow to storm drain efficiently.
8. Structural Soundness	Planter is cracked, leaking or falling apart.			Cracks and leaks are repaired and planter is structurally sound.
9. Miscellaneous	Any condition not covered above that needs attention in order for the flow-through planter to function as designed.			Meet the design specifications.

**Tree Well Filter Maintenance Plan for  
[[= Insert Project Name =]]**

[[= Insert Date =]]



*Proprietary Tree Well Filters typically consist of a pre-cast concrete box with a small tree or shrub planted in engineered media with surface mulch.*

Project Address and Cross Streets

\_\_\_\_\_

Assessor's Parcel No. \_\_\_\_\_

Property Owner: \_\_\_\_\_

Phone No.: \_\_\_\_\_

Designated Contact: \_\_\_\_\_

Phone No.: \_\_\_\_\_

Mailing Address: \_\_\_\_\_

The property contains [[= insert number =]] tree well filter(s), located as described below and as shown in the attached site plan:

- **Tree Well Filter No. 1** is located at [[= describe location =]].
- [[= Add descriptions of other tree well filters, if applicable. =]]

**I. Routine Maintenance Activities**

The principal maintenance objective is to prevent sediment buildup and clogging, which reduces pollutant removal efficiency and may lead to tree well filter failure. Routine maintenance activities, and the frequency at which they will be conducted, are shown in Table 1.

<b>Table 1 Routine Maintenance Activities for Tree Well Filters</b>		
No.	Maintenance Task	Frequency of Task
1	Evaluate health of trees and groundcover. Remove and replace all dead and diseased vegetation. <sup>1</sup>	Twice a year
2	Maintain vegetation and the irrigation system. Prune and weed to keep tree well filter neat and orderly in appearance.	As needed
3	Check that soil media is at appropriate depth and replenish as necessary.	Before wet season and as necessary
4	Check that mulch is at appropriate depth (3 inches per soil specifications) and replenish as necessary. <sup>1</sup>	Before wet season and as necessary

<sup>1</sup> Plant lists, Guidance and Specifications for Biotreatment Soil Media and Mulch and Supplier lists can be found here: [www.flowstobay.org/preventing-stormwater-pollution/with-new-redevelopment/c-3-regulated-projects/](http://www.flowstobay.org/preventing-stormwater-pollution/with-new-redevelopment/c-3-regulated-projects/)

Tree Well Filter Maintenance Plan  
 Property Address: \_\_\_\_\_

Date of Inspection: \_\_\_\_\_  
 Treatment Measure No.: \_\_\_\_\_

<b>Table 1</b> <b>Routine Maintenance Activities for Tree Well Filters</b>		
5	Remove obstructions, accumulated sediment, litter and debris from tree well filter. Confirm that no clogging will occur and that the filter will drain per the design specifications. Dispose of sediment, litter and debris properly.	Before wet season and after large storm events
6	Inspect Tree Well Filter to ensure that it drains between storms and within five days after rainfall.	Before wet season and after large storm events
7	Inspect overflow pipe to ensure that it will safely convey excess flows to storm drain. Repair or replace any damaged or disconnected piping.	As necessary
8	Inspect tree well filter using the attached inspection checklist.	Monthly, or after large storm events, and after removal of accumulated debris or material

**II. Prohibitions**

Do not use pesticides or other chemical applications to treat diseased plants, control weeds or removed unwanted growth. Employ non-chemical controls (biological, physical and cultural controls) to treat a pest problem. Prune plants properly and at the appropriate time of year. Provide adequate irrigation for landscape plants. Do not over water.

**III. Mosquito Abatement**

Standing water shall not remain in the treatment measures for more than five days, to prevent mosquito generation. Should any mosquito issues arise, contact the San Mateo County Mosquito and Vector Control District (SMCMVCD), as needed for assistance. Mosquito larvicides shall be applied only when absolutely necessary, as indicated by the SMCMVCD, and then only by a licensed professional or contractor. Contact information for SMCMVCD is provided below.

San Mateo County Mosquito and Vector Control District  
 1351 Rollins Road  
 Burlingame, CA 94010  
 PH: (650) 344-8592  
 FAX: (650) 344-3843  
[Email: info@smcmvcd.org](mailto:info@smcmvcd.org)

**IV. Inspections**

The attached Tree Well Filter Inspection and Maintenance Checklist shall be used to conduct inspections monthly (or as needed), identify needed maintenance, and record maintenance that is conducted.

## Tree Well Filter Inspection and Maintenance Checklist

Property Address: \_\_\_\_\_

Property Owner: \_\_\_\_\_

Treatment Measure No.: \_\_\_\_\_ Date of Inspection: \_\_\_\_\_ Type of Inspection:  Monthly  Pre-Wet Season

After heavy runoff  End of Wet Season

Inspector(s): \_\_\_\_\_

Other: \_\_\_\_\_

Defect	Conditions When Maintenance Is Needed	Maintenance Needed? (Y/N)	Comments (Describe maintenance completed and if needed maintenance was not conducted, note when it will be done)	Results Expected When Maintenance Is Performed
1. Vegetation	Vegetation is dead, diseased and/or overgrown.			Vegetation is healthy and attractive in appearance.
2. Planting Mix	Planting mix too deep or too shallow.			Planting mix is at proper depth for optimum filtration and flow.
3. Mulch	Mulch is missing or patchy in appearance. Areas of bare earth are exposed, or mulch layer is less than 3 inches in depth.			All bare earth is covered, except mulch is kept 6 inches away from trunks of trees and shrubs. Mulch is even in appearance, at a depth of 3 inches.
4. Trash and Debris Accumulation	Trash and debris accumulated in the tree well filter. Filter does not drain as specified.			Trash and debris removed from tree well filter and disposed of properly. Filter drains per design specifications.
5. Sediment	Evidence of sedimentation in tree well filter.			Material removed so that there is no clogging or blockage. Sediment is disposed of properly.
6. Standing Water	When water stands in the tree well filter between storms and does not drain within five days after rainfall.			There should be no areas of standing water once inflow has ceased. Any of the following may apply: sediment or trash blockages removed, overflow pipe repaired.
7. Overflow Pipe	Does not safely convey excess flows to storm drain. Piping damaged or disconnected.			Overflow pipe conveys excess flow to storm drain efficiently.
8. Miscellaneous	Any condition not covered above that needs attention in order for the tree well filter to function as designed.			Meet the design specifications.

## Infiltration Trench Maintenance Plan for [[== Insert Project Name ==]]

[[== Insert Date ==]]



*An infiltration trench is a long, narrow, excavated trench backfilled with a stone aggregate, and lined with a filter fabric. Runoff is stored in the void space between the stones and infiltrates through the bottom and into the soil matrix.*

Project Address and Cross Streets

\_\_\_\_\_

\_\_\_\_\_

Assessor's Parcel No. \_\_\_\_\_

Property Owner: \_\_\_\_\_

Phone No.: \_\_\_\_\_

Designated Contact: \_\_\_\_\_

Phone No.: \_\_\_\_\_

Mailing Address: \_\_\_\_\_

The property contains [[== insert number ==]] infiltration trench(es), located as described below and as shown in the attached site plan.

- **Infiltration Trench No. 1** is located at [[== describe location ==]].
- [[== Add descriptions of other infiltration trenches, if applicable. ==]]

### I. Routine Maintenance Activities

The principal maintenance objective is to prevent sediment buildup and clogging, which reduces pollutant removal efficiency and may lead to trench failure. Routine maintenance activities, and the frequency at which they will be conducted, are shown in Table 1.

<b>Table 1</b>		
<b>Routine Maintenance Activities for Infiltration Trenches</b>		
No.	Maintenance Task	Frequency of Task
1	Remove obstructions, debris and trash from infiltration trench and dispose of properly.	Monthly, or as needed after storm events
2	Inspect trench to ensure that it drains between storms, and within 5 days after rainfall. Check observation well 2-3 days after storm to confirm drainage.	Monthly during wet season, or as needed after storm events
3	Inspect filter fabric for sediment deposits by removing a small section of the top layer.	Annually
4	Monitor observation well to confirm that trench has drained during dry season.	Annually, during dry season
5	Mow and trim vegetation around the trench to maintain a neat and orderly appearance.	As needed
6	Remove any trash, grass clippings and other debris along the trench perimeter and dispose of properly.	As needed
7	Check for erosion at inflow or overflow structures.	As needed
8	Confirm that cap of observation well is sealed.	At every inspection
9	Inspect infiltration trench using the attached inspection checklist.	Monthly, or after large storm events, and after removal of accumulated debris or material

Infiltration Trench Maintenance Plan  
Property Address: \_\_\_\_\_

Date of Inspection: \_\_\_\_\_  
Treatment Measure No.: \_\_\_\_\_

**II. Prohibitions**

Trees and other large vegetation shall be prevented from growing adjacent to the trench to prevent damage.

**III. Mosquito Abatement**

Standing water shall not remain in the treatment measures for more than five days, to prevent mosquito generation. Should any mosquito issues arise, contact the San Mateo County Mosquito and Vector Control District (SMCMVCD), as needed for assistance. Mosquito larvicides shall be applied only when absolutely necessary, as indicated by the SMCMVCD, and then only by a licensed professional or contractor. Contact information for SMCMVCD is provided below.

San Mateo County Mosquito and Vector Control District  
1351 Rollins Road  
Burlingame, CA 94010  
PH: (650) 344-8592  
FAX: (650) 344-3843  
[Email: info@smcmvcd.org](mailto:info@smcmvcd.org)

**IV. Inspections**

The attached Infiltration Trench Inspection and Maintenance Checklist shall be used to conduct inspections monthly (or as needed), identify needed maintenance, and record maintenance that is conducted.

## Infiltration Trench Inspection and Maintenance Checklist

Property Address: \_\_\_\_\_

Property Owner: \_\_\_\_\_

Treatment Measure No.: \_\_\_\_\_

Date of Inspection: \_\_\_\_\_

Type of Inspection:  Monthly

Pre-Wet Season

After heavy runoff  End of Wet Season

Other: \_\_\_\_\_

Inspector(s): \_\_\_\_\_

Defect	Conditions When Maintenance Is Needed	Maintenance Needed? (Y/N)	Comments (Describe maintenance completed and if needed maintenance was not conducted, note when it will be done)	Results Expected When Maintenance Is Performed
1. Standing Water	When water stands in the infiltration trench between storms and does not drain within 5 days after rainfall.			There should be no areas of standing water once inflow has ceased. Any of the following may apply: sediment or trash blockages removed, improved grade from head to foot of infiltration trench, removed clogging at check dams, or added underdrains.
2. Trash and Debris Accumulation	Trash and debris accumulated in the infiltration trench.			Trash and debris removed from infiltration trench and disposed of properly.
3. Sediment	Evidence of sedimentation in trench. Less than 50% storage volume remaining in sediment traps, forebays or pretreatment swales.			Material removed and disposed of properly so that there is no clogging or blockage.
4. Inlet/Outlet	Inlet/outlet areas clogged with sediment or debris, and/or eroded.			Material removed and disposed of properly so that there is no clogging or blockage in the inlet and outlet areas.
5. Overflow Spillway	Clogged with sediment or debris, and/or eroded.			Material removed and disposed of properly so that there is no clogging or blockage, and trench is restored to design condition.
6. Filter Fabric	Annual inspection, by removing a small section of the top layer, shows sediment accumulation that may lead to trench failure.			Replace filter fabric, as needed, to restore infiltration trench to design condition.
7. Observation Well	Routine monitoring of observation well indicates that trench is not draining within specified time or observation well cap is missing.			Restore trench to design conditions. Observation well cap is sealed.
8. Miscellaneous	Any condition not covered above that needs attention in order for the infiltration trench to function as designed.			Meet the design specifications.

# Extended Detention Basin Maintenance Plan for [[= Insert Project Name =]]

[[= Insert Date =]]



*Extended detention ponds are basins whose outlets have been designed to detain the stormwater runoff from a water quality design storm for some minimum time (e.g., 48 hours) to allow particles and associated pollutants to settle.*

Project Address and Cross Streets

\_\_\_\_\_

Assessor's Parcel No. \_\_\_\_\_

Property Owner: \_\_\_\_\_

Phone No.: \_\_\_\_\_

Designated Contact: \_\_\_\_\_

Phone No.: \_\_\_\_\_

Mailing Address: \_\_\_\_\_

The property contains [[= insert number =]] extended detention basins, located as described below and as shown in the attached site plan.

- **Extended Detention Basin No. 1** is located at [[= describe location =]].
- [[= Add descriptions of other extended detention basins, if applicable. =]]
- [[= Identify Extended Detention Basin(s) designed for Hydromodification Management (HM). =]]

## I. Routine Maintenance Activities

Primary maintenance activities include vegetation management and sediment removal, although mosquito abatement is a concern if the extended detention basin is designed to include permanent pools of standing water. Routine maintenance activities, and the frequency at which they will be conducted, are shown in Table 1.

<b>Table 1</b> <b>Routine Maintenance Activities for Extended Detention Basins</b>		
No.	Maintenance Task	Frequency of Task
1	Conduct annual vegetation management during the summer, removing weeds and harvesting vegetation. Remove all grass cuttings and other green waste.	Once a year
2	Trim vegetation at beginning and end of wet season to prevent establishment of woody vegetation, and for aesthetics and mosquito control.	Twice a year (spring and fall)
3	Evaluate health of vegetation and remove and replace any dead or dying plants. Remove all green waste and dispose of properly.	Twice a year
4	If turf grass is included in basin design, conduct regular mowing and remove all grass cuttings. Avoid producing ruts when mowing.	[[= insert frequency, if applicable =]]



<b>Table 1</b> <b>Routine Maintenance Activities for Extended Detention Basins</b>		
5	Remove sediment from forebay when the sediment level reaches the level shown on the fixed vertical sediment marker and dispose of sediment properly.	As needed
6	Remove accumulated sediment and regrade when the accumulated sediment volume exceeds 10% of basin volume and dispose of sediment properly.	Every 10 years, or as needed [[to maintain 2 in. clearance below low-flow orifice for HM design]]
7	Remove accumulated trash and debris from the extended detention basin at the middle and end of the wet season and dispose of trash and debris properly.	Twice a year (January and April)
8	Irrigate during dry weather.	[[= insert frequency =]]
9	Inspect extended detention basin using the attached inspection checklist.	Quarterly, or as needed

**II. Prohibitions**

Do not use pesticides or other chemical applications to treat diseased plants, control weeds or removed unwanted growth. Employ non-chemical controls (biological, physical and cultural controls) to treat a pest problem. Prune plants properly and at the appropriate time of year. Provide adequate irrigation for landscape plants. Do not over water.

**III. Mosquito Abatement Contact Information**

Standing water shall not remain in the treatment measures for more than five days, to prevent mosquito generation. Should any mosquito issues arise, contact the San Mateo County Mosquito and Vector Control District (SMCMVCD), as needed for assistance. Mosquito larvicides shall be applied only when absolutely necessary, as indicated by the SMCMVCD, and then only by a licensed professional or contractor. Contact information for SMCMVCD is provided below.

San Mateo County Mosquito and Vector Control District  
 1351 Rollins Road  
 Burlingame, CA 94010  
 PH: (650) 344-8592  
 FAX: (650) 344-3843  
[Email: info@smcmvcd.org](mailto:info@smcmvcd.org)

**IV. Inspections**

The attached Extended Detention Basin Inspection and Maintenance Checklist shall be used to conduct inspections monthly (or as needed), identify needed maintenance, and record maintenance that is conducted.

## Extended Detention Basin Inspection and Maintenance Checklist

Property Address: \_\_\_\_\_

Property Owner: \_\_\_\_\_

Treatment Measure No.: \_\_\_\_\_ Date of Inspection: \_\_\_\_\_ Type of Inspection:  Monthly  Pre-Wet Season  
 After heavy runoff  End of Wet Season  
 Other: \_\_\_\_\_

Inspector(s): \_\_\_\_\_

Defect	Conditions When Maintenance Is Needed	Maintenance Needed? (Y/N)	Comments (Describe maintenance completed and if any needed maintenance was not conducted, note when it will be done.)	Results Expected When Maintenance Is Performed
<b>General</b>				
Trash & Debris	<ul style="list-style-type: none"> <li>• Trash and debris accumulated in basin.</li> <li>• Visual evidence of dumping.</li> </ul>			Trash and debris cleared from site and disposed of properly.
Poisonous Vegetation and noxious weeds	Poisonous or nuisance vegetation or noxious weeds, e.g., morning glory, English ivy, reed canary grass, Japanese knotweed, purple loosestrife, blackberry, Scotch broom, poison oak, stinging nettles, or devil's club.			Use Integrated Pest Management techniques to control noxious weeds or invasive species.
Contaminants and Pollution	Any evidence of oil, gasoline, contaminants or other pollutants.			No contaminants or pollutants present.
Rodent Holes	If facility acts as a dam or berm, any evidence of rodent holes, or any evidence of water piping through dam or berm via rodent holes.			The design specifications are not compromised by holes. Any rodent control activities are in accordance with applicable laws and do not affect any protected species.
Insects	Insects such as wasps and hornets interfere with maintenance activities.			Insects do not interfere with maintenance activities.

Defect	Conditions When Maintenance Is Needed	Maintenance Needed? (Y/N)	Comments (Describe maintenance completed and if any needed maintenance was not conducted, note when it will be done.)	Results Expected When Maintenance Is Performed
Tree/Brush Growth and Hazard Trees	<ul style="list-style-type: none"> <li>• Growth does not allow maintenance access or interferes with maintenance activity.</li> <li>• Dead, diseased, or dying trees.</li> </ul>			<ul style="list-style-type: none"> <li>• Trees do not hinder maintenance activities.</li> <li>• Remove hazard trees as approved by the City. (Use a certified Arborist to determine health of tree or removal requirements).</li> </ul>
Drainage time	Standing water remains in basin more than five days.			Correct any circumstances that restrict the flow of water from the system. Restore drainage to design condition. If the problem cannot be corrected and problems with standing water recur, then mosquitoes should be controlled with larvicides, applied by a licensed pesticide applicator.
Outfall structure	Debris or silt build-up obstructs an outfall structure.			Remove debris and/or silt build-up and dispose of properly.
<b>Side Slopes</b>				
Erosion	<ul style="list-style-type: none"> <li>• Eroded over 2 in. deep where cause of damage is still present or where there is potential for continued erosion.</li> <li>• Any erosion on a compacted berm embankment.</li> </ul>			Cause of erosion is managed appropriately. Side slopes or berm are restored to design specifications, as needed.
<b>Storage Area</b>				
Sediment	Accumulated sediment >10% of designed basin depth or affects inletting or outletting condition of the facility.			Sediment cleaned out to designed basin shape and depth; basin reseeded if necessary to control erosion. Sediment disposed of properly.
Liner (If Applicable)	Liner is visible and has more than three 1/4-inch holes in it.			Liner repaired or replaced. Liner is fully covered.
<b>Emergency Overflow/ Spillway and Berms</b>				
Settlement	Berm settlement 4 inches lower than the design elevation.			Dike is built back to the design elevation.

Defect	Conditions When Maintenance Is Needed	Maintenance Needed? (Y/N)	Comments (Describe maintenance completed and if any needed maintenance was not conducted, note when it will be done.)	Results Expected When Maintenance Is Performed
Tree Growth	Tree growth on berms or emergency spillway >4 ft in height or covering more than 10% of spillway.			<ul style="list-style-type: none"> <li>Trees should be removed. If root system is small (base less than 4 inches) the root system may be left in place. Otherwise the roots should be removed and the berm restored.</li> <li>A civil engineer should be consulted for proper berm/spillway restoration.</li> </ul>
Emergency Overflow/ Spillway	Rock is missing and soil is exposed at top of spillway or outside slope.			Rocks and pad depth are restored to design standards.
<b>Debris Barriers (e.g., Trash Racks)</b>				
Trash and Debris	Trash or debris is plugging openings in the barrier.			Trash or debris is removed and disposed of properly.
Damaged/ Missing Bars	Bars are missing, loose, bent out of shape, or deteriorating due to excessive rust.			Bars are repaired or replaced to allow proper functioning of trash rack.
Inlet/Outlet Pipe	Debris barrier is missing or not attached to pipe.			Debris barrier is repaired or replaced to allow proper functioning of trash rack.
<b>Fencing and Gates</b>				
Missing or broken parts	Any defect in or damage to the fence or gate that permits easy entry to a facility.			Fencing and gate are restored to design specifications.
Deteriorating Paint or Protective Coating	Part or parts that have a rusting or scaling condition that has affected structural adequacy.			Paint or protective coating is sufficient to protect structural adequacy of fence or gate.
<b>Flow Duration Control Outlet (if included in design to meet Hydromodification Management Standard) [[=refer to any attachments with additional provisions=]]</b>				
Risers, orifices and screens	Any debris or clogging			Restore unobstructed flow through discharge structure; to meet original design; dispose of debris properly.
<b>Miscellaneous</b>				
Miscellaneous	Any condition not covered above that needs attention to restore extended detention basin to design conditions.			Meets the design specifications.

**Pervious Pavement Maintenance Plan for**  
**[[= Insert Project Name =]]**

[[= Insert Date =]]

Project Address and Cross Streets \_\_\_\_\_

Assessor's Parcel No.: \_\_\_\_\_

Property Owner: \_\_\_\_\_ Phone No.: \_\_\_\_\_

Designated Contact: \_\_\_\_\_ Phone No.: \_\_\_\_\_

Mailing Address: \_\_\_\_\_

The property contains [[= insert number =]] pervious pavement area(s), located and sized as described below and as shown in the attached site plan<sup>1</sup>. Of those pervious pavement areas, [[= insert number =]] are each 3,000 sq.ft. or more in area. Total square feet of pervious pavement on the site = [[= insert number =]].

Square feet of area

- **Pervious Pavement Area No. 1** is located at [[= describe location =]] X square feet
- [[= Add descriptions of other pervious pavement areas, if applicable. =]] X square feet

**I. Routine Maintenance Activities**

Types of pervious pavement include pervious concrete, porous asphalt, pervious pavers, permeable pavers, and reinforced grid paving. The principal maintenance objective is to prevent sediment buildup and clogging, which reduces infiltration capacity and pollutant removal efficiency. Routine maintenance activities, and the frequency at which they will be conducted, are shown in Table 1.

<b>Table 1</b>		
<b>Routine Maintenance Activities for Pervious Pavement Areas</b>		
<b>No.</b>	<b>Maintenance Task</b>	<b>Frequency of Task</b>
1	Check for sediment and debris accumulation. Prevent soil from washing or blowing onto the pavement. Do not store sand, soil, mulch or other landscaping materials on pervious pavement surfaces.	Two to four times annually
2	Conduct preventative surface cleaning, using commercially available regenerative air or vacuum sweepers, to remove sediment and debris.	Two to four times annually
3	Inspect for any signs of pavement failure. Repair any surface deformations or broken pavers. Replace missing joint filler between pavers.	Two to four times annually
4	Check for standing water on the pavement surface within 30 minutes after a storm event.	Two to four times annually
5	Inspect underdrain outlets and cleanouts, preferably before the wet season. Remove trash/debris.	Two to four times annually
6	Remove sediment and debris accumulation on pervious pavement.	Two to four times annually
7	Remove weeds. Mow vegetation on reinforced grid paving (such as turf block) as needed.	As needed
8	Perform restorative surface cleaning with a vacuum sweeper, and/or reconstruction of part of the pervious surface to restore surface permeability as needed. Replenish aggregate in permeable paver joints or in grids as needed after restorative surface cleaning.	As needed

<sup>1</sup> Attached site plan must match the site plan exhibit to Maintenance Agreement.

<b>Table 1</b>		
<b>Routine Maintenance Activities for Pervious Pavement Areas</b>		
<b>No.</b>	<b>Maintenance Task</b>	<b>Frequency of Task</b>
9	Power washing with simultaneous vacuuming also can be used to restore surface infiltration to highly clogged areas of pervious concrete, porous asphalt, pervious pavers or permeable pavers, but is not recommended for reinforced grid paving.	As needed
10	Inspect pervious pavement area using the attached inspection checklist.	Quarterly or as needed

**II. Prohibitions**

Do not use pesticides or other chemical applications to control weeds or unwanted growth near pavement or between pavers.

**III. Mosquito Abatement**

Standing water shall not remain in the treatment measures for more than five days, to prevent mosquito generation. Should any mosquito issues arise, contact the San Mateo County Mosquito and Vector Control District (SMCMVCD), as needed for assistance. Mosquito larvicides shall be applied only when absolutely necessary, as indicated by the SMCMVCD, and then only by a licensed professional or contractor. Contact information for SMCMVCD is provided below.

San Mateo County Mosquito and Vector Control District  
 1351 Rollins Road  
 Burlingame, CA 94010  
 PH: (650) 344-8592  
 FAX: (650) 344-3843  
[Email: info@smcmvcd.org](mailto:info@smcmvcd.org)

**IV. Inspections**

The attached Pervious Pavement Inspection and Maintenance Checklist shall be used to conduct inspections monthly (or as needed), identify needed maintenance, and record maintenance that is conducted.

## Pervious Pavement Inspection and Maintenance Checklist

Property Address: \_\_\_\_\_

Property Owner: \_\_\_\_\_

Treatment Measure No.: \_\_\_\_\_ Date of Inspection: \_\_\_\_\_ Type of Inspection  Monthly  Pre-Wet Season

After heavy runoff  End of Wet Season

Inspector(s): \_\_\_\_\_

Other: \_\_\_\_\_

Defect	Conditions When Maintenance Is Needed	Maintenance Needed? (Y/N)	Comments (Describe maintenance completed and if needed maintenance was not conducted, note when it will be done)	Results Expected When Maintenance Is Performed
1. Standing Water	Water stands in the pervious pavement and does not drain within 30 minutes after storm event			There should be no areas of standing water once storm event has ceased. Restorative surface cleaning with a vacuum sweeper and/or reconstruction of part of the pervious surface may be required.
2. Trash, or Sediment and Debris Accumulation	Trash, sediment or debris accumulated on pervious pavement			Trash and debris removed from pervious pavement and disposed of properly. Adjacent areas do not contribute to sediment and debris.
3. Damage	Surface deformation or broken pavers			Surface restored; no deformation or broken pavers.
4. Vegetation	Weeds growing on pervious pavement			No weeds on pervious pavement.
5. Underdrain Outlets	Water accumulates due to trash/sediment accumulation in outlets.			No standing water observed. Clean underdrain outlets and cleanouts.
5. Miscellaneous	Any condition not covered above that needs attention in order for the pervious pavement to function as designed.			Meets the design specifications.

# Rainwater Harvesting Systems Maintenance Plan for [[= Insert Project Name =]]

[[= Insert Date =]]

Project Address and Cross Streets \_\_\_\_\_

Assessor's Parcel No.: \_\_\_\_\_

Property Owner: \_\_\_\_\_ Phone No.: \_\_\_\_\_

Designated Contact: \_\_\_\_\_ Phone No.: \_\_\_\_\_

Mailing Address: \_\_\_\_\_

The property contains [[= insert number =]] pervious paving area(s), located as described below and as shown in the attached site plan<sup>1</sup>.

- **Rainwater Harvesting System No. 1** is located at [[= describe location =]].
- [[= Add descriptions of other rainwater harvesting systems, if applicable. =]]

## I. Routine Maintenance Activities

The principal maintenance objective is to prevent sediment buildup and clogging, which reduce rainwater harvesting capacity. Routine maintenance activities, and the frequency at which they will be conducted, are shown in Table 1.

Table 1 Routine Maintenance Activities for Rainwater Harvesting Systems		
No.	Maintenance Task	Frequency of Task
1	Inspect and clean filters and screens, and replace as needed.	Every 3-6 months
2	Inspect and clean debris from gutters, downspouts, first-flush devices and roof washers.	Every 3-6 months
3	Inspect and verify that disinfection, filters, and other water quality treatment devices are operational, in accordance with manufacture's recommendations or local jurisdictional requirements.	Every 3-6 months
4	Inspect and clean debris from rainwater gutters, roof surfaces, downspouts, roof washers, and first-flush devices, Remove tree branches and vegetation overhanging roof surfaces.	Every 6 months, or as needed to prevent clogging
5	If rainwater is provided for indoor use, conduct annual water quality testing per the requirements of the local jurisdiction.	Every 3-6 months
6	Inspect all components, including pumps, valves, tanks, backflow prevention systems, and verify operations.	Annually
7	Flush or vacuum cisterns to remove sediment. Drain flushed water to landscaping or sanitary sewer.	Annually
8	Inspect rainwater harvesting systems using the attached inspection checklist.	Quarterly or as needed

<sup>1</sup> Attached site plan must match the site plan exhibit to Maintenance Agreement.



Rainwater Harvesting Systems Maintenance Plan  
Property Address: \_\_\_\_\_

Date of Inspection: \_\_\_\_\_  
Treatment Measure No.: \_\_\_\_\_

## II. Mosquito Abatement

Standing water shall not remain in the treatment measures for more than five days, to prevent mosquito generation. Should any mosquito issues arise, contact the San Mateo County Mosquito and Vector Control District (SMCMVCD), as needed for assistance. Mosquito larvicides shall be applied only when absolutely necessary, as indicated by the SMCMVCD, and then only by a licensed professional or contractor. Contact information for SMCMVCD is provided below.

San Mateo County Mosquito and Vector Control District  
1351 Rollins Road  
Burlingame, CA 94010  
PH: (650) 344-8592  
FAX: (650) 344-3843  
[Email: info@smcmvcd.org](mailto:info@smcmvcd.org)

## III. Inspections

The attached Treatment Measure Inspection and Maintenance Checklist shall be used to conduct inspections monthly (or as needed), identify needed maintenance, and record maintenance that is conducted.

## Rainwater Harvesting Systems Inspection and Maintenance Checklist

Property Address: \_\_\_\_\_

Property Owner: \_\_\_\_\_

Treatment Measure No.: \_\_\_\_\_

Date of Inspection: \_\_\_\_\_

Type of Inspection:  Monthly

Pre-Wet Season

After heavy runoff  End of Wet Season

Inspector(s): \_\_\_\_\_

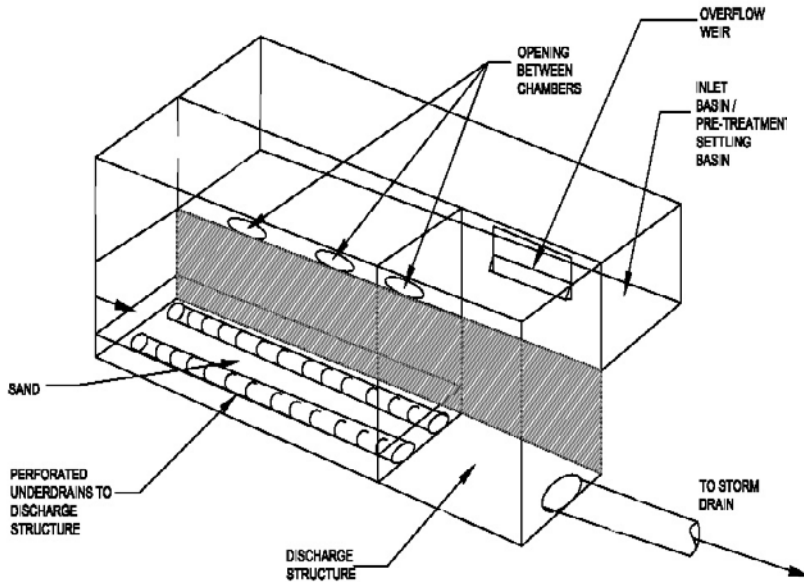
Other: \_\_\_\_\_

Defect	Conditions When Maintenance Is Needed	Maintenance Needed? (Y/N)	Comments (Describe maintenance completed and if needed maintenance was not conducted, note when it will be done)	Results Expected When Maintenance Is Performed
1. Sediment and Debris Accumulation	Sediment or debris accumulated in filters, screens, gutters, downspouts, first-flush devices, or roof washers, or on roof or other collection surfaces. Sediment accumulated in cistern(s).			Sediment and debris removed and disposed of properly. Collection surfaces do not contribute sediment and debris.
2. Leaks	Water leaking from system.			No leakage.
3. Water Quality	Treatment system is not working properly.			Treatment system is operational and maintaining minimum water quality requirements.
4. Miscellaneous	Any condition not covered above that needs attention in order for the rainwater harvesting system to function as designed.			Meets the design specifications.

**Non-Proprietary Media Filter Maintenance Plan for  
[[= Insert Project Name =]]**

[[= Insert Date =]]

**MODIFIED DELAWARE SAND FILTER**



*Non-proprietary media filters are usually two-chambered, including a pretreatment settling basin and a filter bed filled with sand or other absorptive filtering media. As stormwater flows into the first chamber, large particles settle out, and then finer particles and other pollutants are removed as stormwater flows through the filtering media in the second chamber.*

Project Address and Cross Streets \_\_\_\_\_

Assessor's Parcel No.: \_\_\_\_\_

Property Owner: \_\_\_\_\_

Phone No.: \_\_\_\_\_

Designated Contact: \_\_\_\_\_

Phone No.: \_\_\_\_\_

Mailing Address: \_\_\_\_\_

The property contains [[= insert number =]] non-proprietary media filter(s), located as described below and as shown in the attached site plan<sup>1</sup>.

- **Non-Proprietary Media Filter No. 1** is located at [[= describe location =]].
- [[= Add descriptions of other non-proprietary media filters, if applicable. =]]

**I. Routine Maintenance Activities**

The principal maintenance objective is to prevent sediment buildup and clogging, which reduces pollutant removal efficiency and may lead to Non-Proprietary Media Filter failure. Routine maintenance activities, and the frequency at which they will be conducted, are shown in Table 1.

<sup>1</sup> Attached site plan must match the site plan exhibit to Maintenance Agreement.

<b>Table 1</b>		
<b>Routine Maintenance Activities for Non-Proprietary Media Filters</b>		
<b>No.</b>	<b>Maintenance Task</b>	<b>Frequency of Task</b>
1	Inspect for standing water, sediment, trash and debris.	Monthly during rainy season
2	Remove sediment, trash and debris from sedimentation basin, riser pipe and filter bed. Dispose of sediment, trash and debris properly.	As needed
3	Ensure that non-proprietary media filter drains completely within five days.	After major storm events and as needed.
4	For non-proprietary media filters with a filter bed, inspect media depth to ensure proper drainage.	Monthly during rainy season, or as needed after storm events
5	Inspect non-proprietary media filter using the attached inspection checklist.	Monthly, or after large storm events, and after removal of accumulated debris or material

**II. Prohibitions**

Trees and other large vegetation shall be prevented from growing adjacent to the non-proprietary media filter to prevent damage.

**III. Mosquito Abatement**

Standing water shall not remain in the treatment measures for more than five days, to prevent mosquito generation. Should any mosquito issues arise, contact the San Mateo County Mosquito and Vector Control District (SMCMVCD), as needed for assistance. Mosquito larvicides shall be applied only when absolutely necessary, as indicated by the SMCMVCD, and then only by a licensed professional or contractor. Contact information for SMCMVCD is provided below.

San Mateo County Mosquito and Vector Control District  
 1351 Rollins Road  
 Burlingame, CA 94010  
 PH: (650) 344-8592  
 FAX: (650) 344-3843  
[Email: info@smcmvcd.org](mailto:info@smcmvcd.org)

**IV. Inspections**

The attached Non-Proprietary Media Filter Inspection and Maintenance Checklist shall be used to conduct inspections monthly (or as needed), identify needed maintenance, and record maintenance that is conducted. **Third-party inspections by qualified inspection companies may be provided to the municipality. Before and after photos (date stamped) must be provided with the inspection report.**

## Non-Proprietary Media Filter Inspection and Maintenance Checklist

Property Owner: \_\_\_\_\_

Property Address: \_\_\_\_\_

Date of Inspection: \_\_\_\_\_

Type of Inspection:       Monthly                               Pre-Wet Season  
 After heavy runoff               End of Wet Season  
 Third-Party Inspection/Maintenance Company

System Type: \_\_\_\_\_

Installer/Contractor: \_\_\_\_\_

Manufacturer: \_\_\_\_\_

Inspector Name(s): \_\_\_\_\_

Third-Party Inspection Company: \_\_\_\_\_

Email address of Third-Party Inspector: \_\_\_\_\_

Phone number of Third-Party Inspector: \_\_\_\_\_

**Before & after photos (date stamped) provided to Municipality (Required):**  Yes

Defect	Conditions When Maintenance Is Needed	Maintenance Needed? (Y/N)	Comments (Describe maintenance completed and if needed maintenance was not conducted, note when it will be done)	Results Expected When Maintenance Is Performed
1. Sediment, trash and debris accumulation	Sediment, trash and debris accumulated in the sedimentation basin, riser pipe and filter bed. Filter does not drain as specified.			Sediment, trash and debris removed from sedimentation basin, riser pipe and filter bed and disposed of properly. Filter drains per design specifications.
2. Standing water	Non-proprietary media filter does not drain within five days after rainfall.			Clogs removed from sedimentation basin, riser pipe and filter bed. Filter drains per design specifications.
3. Mosquitoes	Evidence of mosquito larvae in non-proprietary media filter.			Clogs removed from sedimentation basin, riser pipe and filter bed. Filter drains per design specifications.
4. Filter bed	Overall media depth 300 millimeters (12 inches) or less.			Media depth restored to 450 millimeters (18 inches).
5. Miscellaneous	Any condition not covered above that needs attention in order for the non-proprietary media filter to function as designed.			Meet the design specifications.

**Manufactured Stormwater Treatment Measure Maintenance Plan for  
[[= Insert Project Name =]]**

[[= Insert Date =]]

Manufactured Stormwater Treatment Measures are **PROPRIETARY** treatment devices that tend to be installed below ground and operate using some type of proprietary filter media, hydrodynamic separation, or sedimentation and screening. Common examples of manufactured treatment measures include manufactured media filters, inlet filters or drain inserts, oil/water separators and hydrodynamic separators. In August 2004, the Regional Water Board’s Executive Office wrote a letter stating that a project relying on inlet filters or oil/water separators as the sole treatment measure would be unlikely to meet the maximum extent practicable standard of the National Pollutant Discharge Elimination System Permit. See the Countywide C.3 Technical Guidance ([www.flowstobay.org](http://www.flowstobay.org)) for more information.

Project Address: \_\_\_\_\_

Assessor’s Parcel No.: \_\_\_\_\_

Property Owner: \_\_\_\_\_ Phone No.: \_\_\_\_\_

Designated Contact: \_\_\_\_\_ Phone No.: \_\_\_\_\_

Mailing Address: \_\_\_\_\_

The property contains [[= insert number =]], [[=insert device type/manufacture=]] located as described below and as shown in the attached site plan<sup>1</sup>.

- [[=device name =]] is located at [[= describe location =]].
- [[= Add descriptions of other products, if applicable. =]]

**I. Routine Maintenance Activities**

The principal maintenance objective is to prevent sediment buildup and clogging, which reduces pollutant removal efficiency and may lead to failure of the manufactured treatment measure. Routine maintenance activities, and the frequency at which they will be conducted, are shown in Table 1.

Table 1 Routine Maintenance Activities for Manufactured Treatment Measures		
No.	Maintenance Task	Frequency of Task
1	Inspect for standing water, sediment, trash and debris.	Monthly during rainy season
2	Remove sediment, trash and debris from sedimentation basin, riser pipe and filter bed, using vactor truck method. Dispose of sediment, trash, filters and debris properly.	As needed
3	Ensure that manufactured treatment measure drains completely within five days.	After major storm events and as needed.
4	Inspect outlets to ensure proper drainage.	Monthly during rainy season, or as needed after storm events
5	Follow manufacturer’s guidelines for maintenance and cartridge replacement.	As per manufacturer’s specifications.
6	Inspect manufactured treatment measure, using the attached inspection checklist.	Monthly, or after large storm events, and after removal of accumulated debris or material

<sup>1</sup> Attached site plan must match the site plan exhibit to Maintenance Agreement.

Manufactured Treatment Measure Maintenance Plan  
Property Address: \_\_\_\_\_

Date of Inspection: \_\_\_\_\_  
Treatment Measure No.: \_\_\_\_\_

## II. Prohibitions

Trees and other large vegetation shall be prevented from growing adjacent to the manufactured treatment measure to prevent damage.

## III. Mosquito Abatement

Standing water shall not remain in the treatment measures for more than five days, to prevent mosquito generation. Should any mosquito issues arise, contact the San Mateo County Mosquito and Vector Control District (SMCMVCD), as needed for assistance. Mosquito larvicides shall be applied only when absolutely necessary, as indicated by the SMCMVCD, and then only by a licensed professional or contractor. Contact information for SMCMVCD is provided below.

San Mateo County Mosquito and Vector Control District  
1351 Rollins Road  
Burlingame, CA 94010  
PH: (650) 344-8592  
FAX: (650) 344-3843  
[Email: info@smcmvcd.org](mailto:info@smcmvcd.org)

## IV. Inspections

The attached Treatment Measure Inspection and Maintenance Checklist shall be used to conduct inspections monthly (or as needed), identify needed maintenance, and record maintenance that is conducted. The municipality may contract with qualified inspection companies to perform third-party inspections on its behalf.

## Manufactured Stormwater Treatment Measure Inspection and Maintenance Checklist

Property Owner: \_\_\_\_\_

Property Address: \_\_\_\_\_

Date of Inspection: \_\_\_\_\_

Type of Inspection:      Monthly                              Pre-Wet Season  
                                    After heavy runoff              End of Wet Season  
                                    Third-Party Inspection/Maintenance Company

System Type: \_\_\_\_\_

Installer/Contractor: \_\_\_\_\_

Manufacturer: \_\_\_\_\_

Inspector Name(s): \_\_\_\_\_

Third-Party Inspection Company: \_\_\_\_\_

Email address of Third-Party Inspector: \_\_\_\_\_

Phone number of Third-Party Inspector: \_\_\_\_\_

Before & after photos (date stamped) provided to Municipality (Required):  Yes

Defect	Conditions When Maintenance Is Needed	Maintenance Needed? (Y/N)	Comments (Describe maintenance completed and if needed maintenance was not conducted, note when it will be done)	Results Expected When Maintenance Is Performed
1. Sediment, trash and debris accumulation on Filter	Sediment, trash and debris accumulated in the sedimentation basin, riser pipe, retention pipes and filter bed. Filter does not drain as specified.			Sediment, trash and debris removed from sedimentation basin, riser pipe and filter bed and disposed of properly. Filter drains per design specifications. Empty cartridge should be reassembled and reinstalled.
2. Standing water	Manufactured treatment measure does not drain within five days after rainfall.			Clogs removed from filters, sedimentation basin, riser pipe and filter bed. Filter drains per design specifications.
3. Mosquitoes	Evidence of mosquito larvae in manufactured treatment measure.			Clogs removed from sedimentation basin, riser pipe and filter bed. Filter drains per design specifications.
4. Miscellaneous	Any condition not covered above that needs attention in order for the manufactured treatment measure to function as designed.			Meet the design specifications.



# Appendix H: Areas Subject to Hydromodification Management Requirements

This appendix presents the countywide Hydromodification Management (HM) Control Area Map, which identifies the geographical areas that are subject to hydromodification management (HM) requirements. The full countywide HM Control Area Map is followed by a series of maps that show detailed areas of the county in which the HM control area boundary does not follow major roadways.

<i>Map Name</i>	<i>Page(s)</i>
<i>H1 Countywide HM Control Area Map</i> .....	<i>H-2</i>
<i>H2 Map Index for HM Control Area in Selected Areas of San Mateo County</i> .....	<i>H-3</i>
<i>H3 City of Atherton (Map 1 of 1)</i> .....	<i>H-4</i>
<i>H4 Cities of Brisbane and South San Francisco (Map 1 of 1)</i> .....	<i>H-5</i>
<i>H5 Cities of Colma and South San Francisco (Map 1 of 1)</i> .....	<i>H-6</i>
<i>H6 Daly City and Brisbane (Map 1 of 1)</i> .....	<i>H-7</i>
<i>H7 Daly City and Unincorporated County (Maps 1 and 2)</i> .....	<i>H-8, 9</i>
<i>H8 City of Millbrae (Map 1 of 1)</i> .....	<i>H-10</i>
<i>H9 Cities of Millbrae and Burlingame (Maps 1 and 2)</i> .....	<i>H-11, 12</i>
<i>H10 City of Pacifica (Maps 1 and 2)</i> .....	<i>H-13, 14</i>
<i>H11 Cities of Pacifica, San Bruno and South San Francisco (Map 1 of 1)</i> .....	<i>H-15</i>
<i>H12 Cities Redwood City and San Carlos (Map 1 of 1)</i> .....	<i>H-16</i>
<i>H13 Cities of San Bruno and Millbrae (Maps 1 and 2)</i> .....	<i>H-17, 18</i>
<i>H14 City of San Mateo (Map 1 of 1)</i> .....	<i>H-19</i>
<i>H15 Cities of San Mateo and Hillsborough (Map 1 of 1)</i> .....	<i>H-20</i>


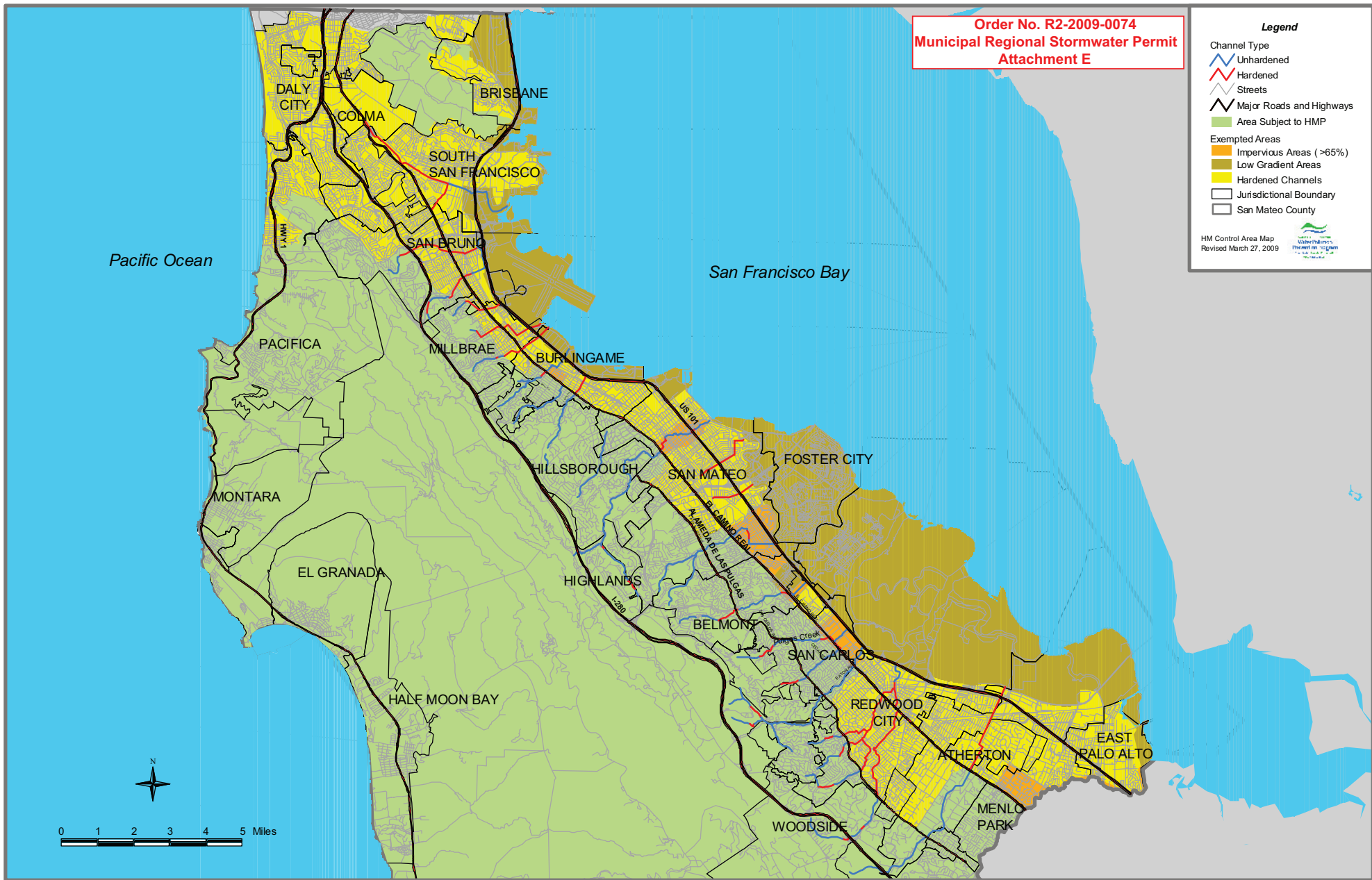
Requirements vary from one municipality to the next. Contact the local jurisdiction to obtain electronic files for use in preparing these documents, and to obtain information on municipality-specific requirements.

**Order No. R2-2009-0074  
Municipal Regional Stormwater Permit  
Attachment E**

**Legend**





- Channel Type
  - Unhardened
  - Hardened
  - Streets
  - Major Roads and Highways
- Area Subject to HMP
- Exempted Areas
  - Impervious Areas (>65%)
  - Low Gradient Areas
  - Hardened Channels
- Jurisdictional Boundary
- San Mateo County

HM Control Area Map  
Revised March 27, 2009





# MAP INDEX FOR HM CONTROL AREA IN SELECTED AREAS OF SAN MATEO COUNTY\*


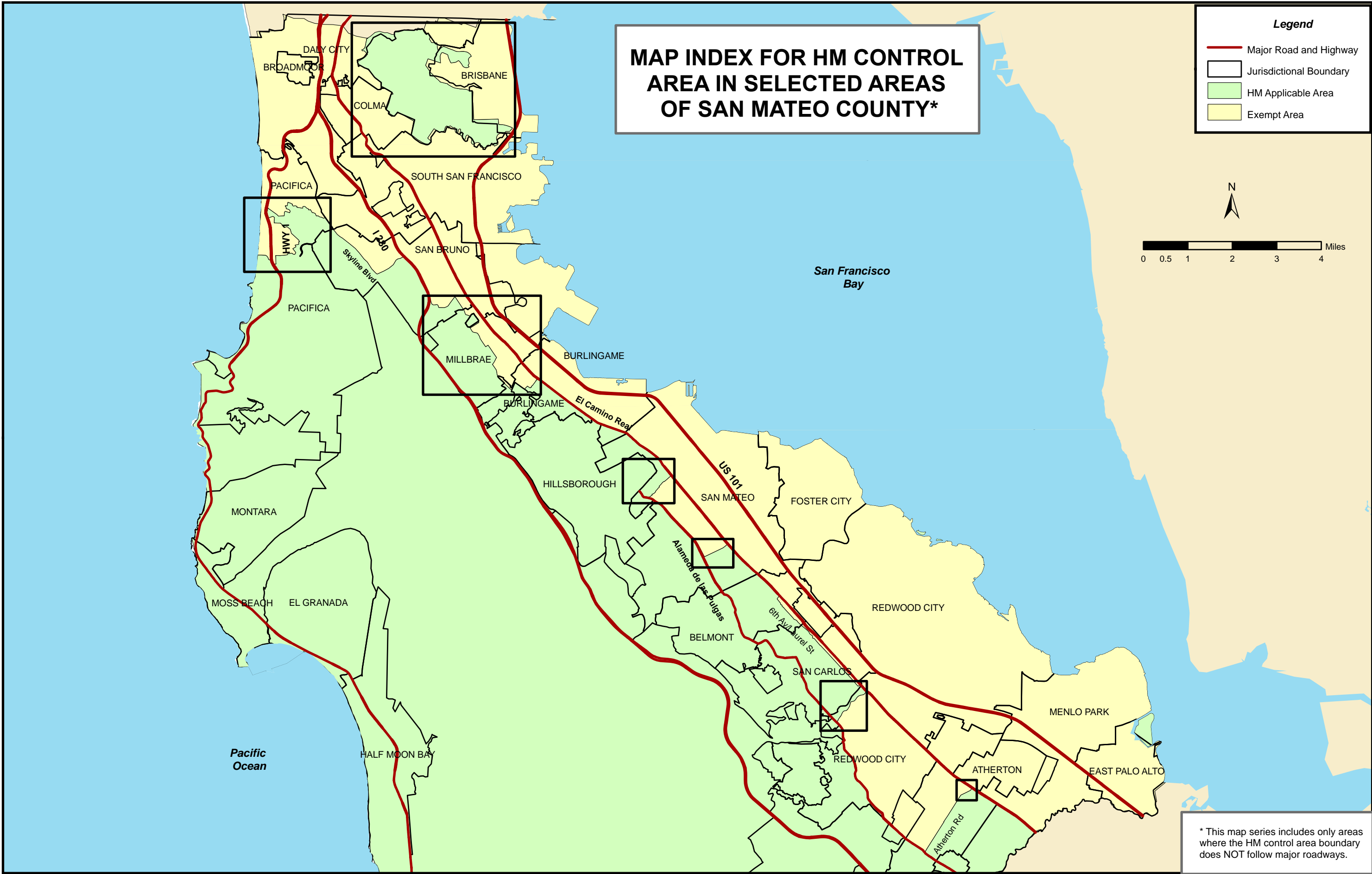
**Legend**

-  Major Road and Highway
-  Jurisdictional Boundary
-  HM Applicable Area
-  Exempt Area

N

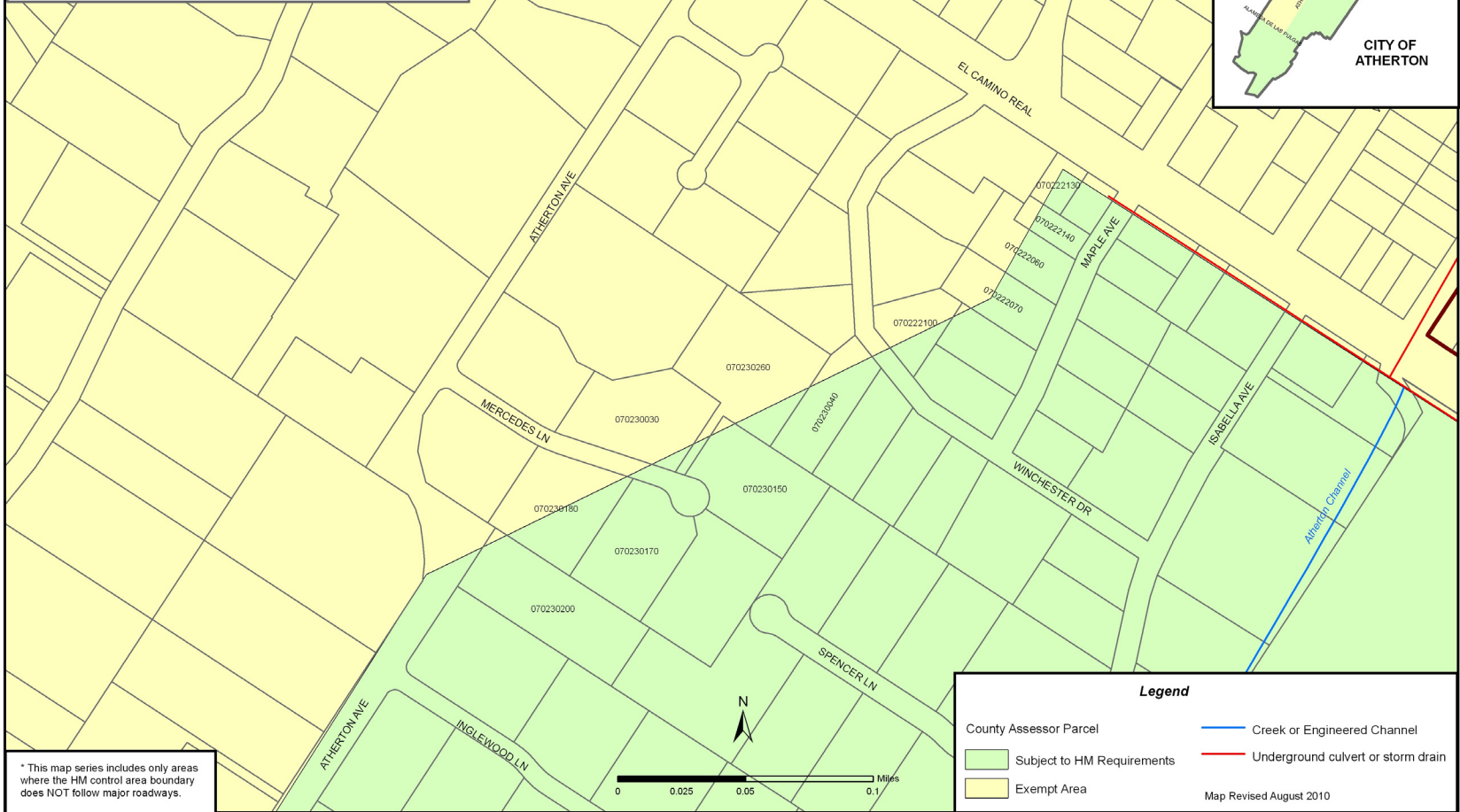


0 0.5 1 2 3 4 Miles

\* This map series includes only areas where the HM control area boundary does NOT follow major roadways.

**City of Atherton  
Hydromodification Management (HM)  
Control Area Boundary for Selected Areas \*  
Map 1 of 1**



\* This map series includes only areas where the HM control area boundary does NOT follow major roadways.

**Legend**

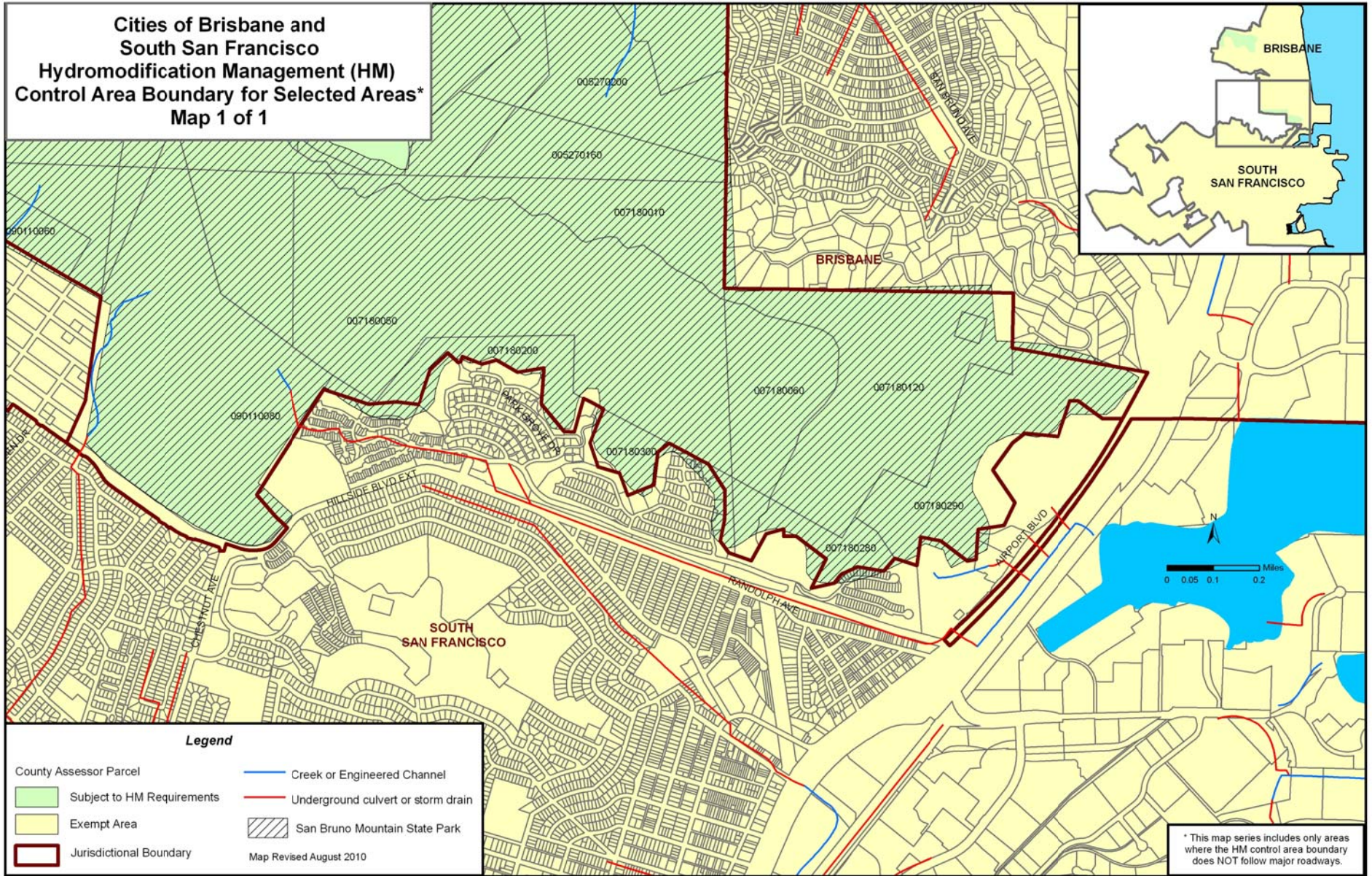
County Assessor Parcel	Creek or Engineered Channel
Subject to HM Requirements	Underground culvert or storm drain
Exempt Area	

Map Revised August 2010

REFER TO BRISBANE AND DALY CITY MAP 1

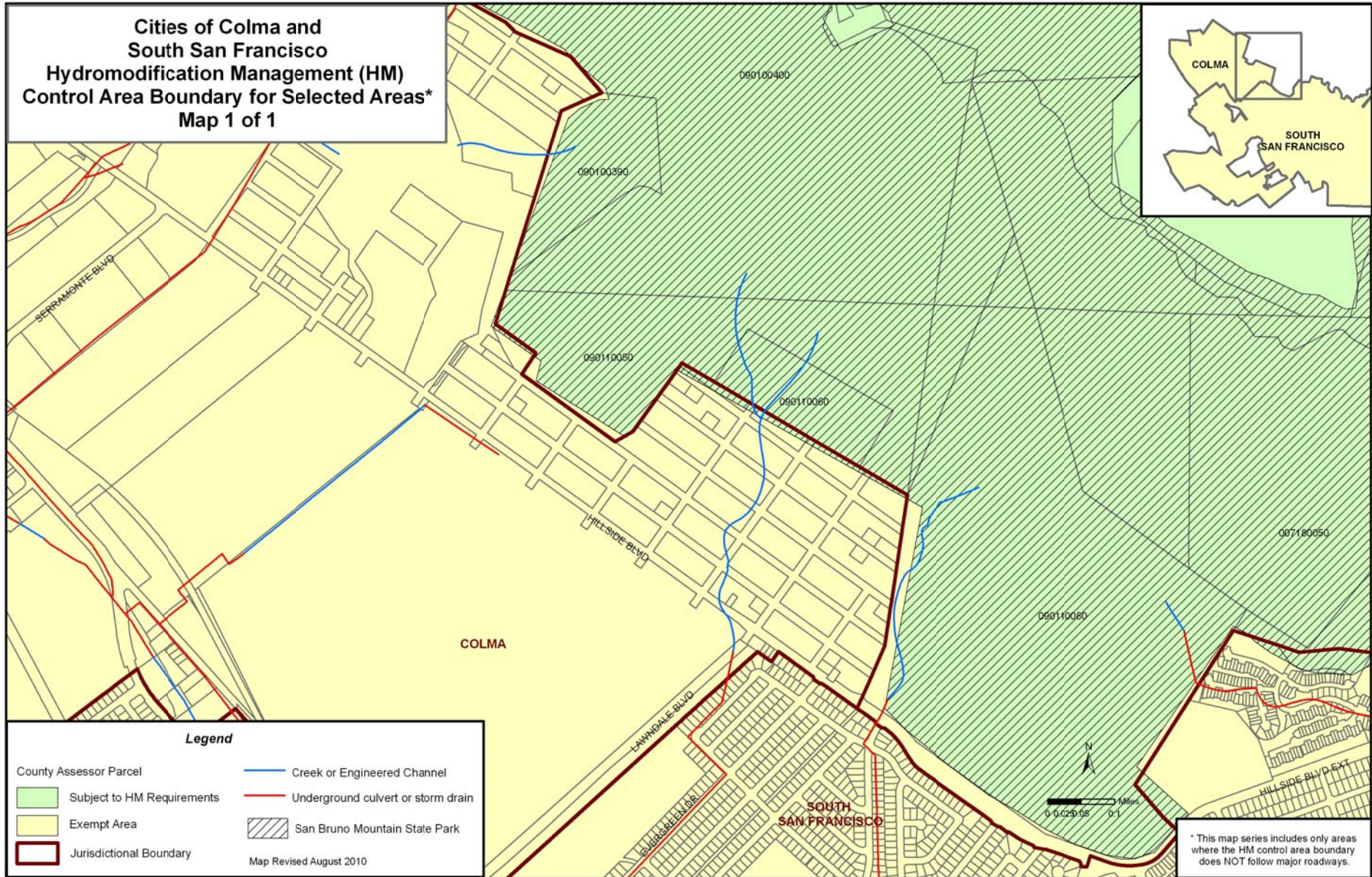
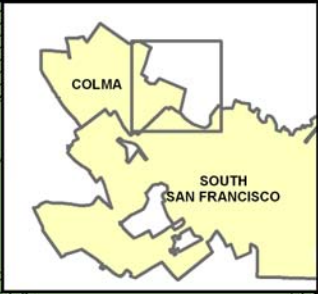
Cities of Brisbane and South San Francisco  
Hydromodification Management (HM)  
Control Area Boundary for Selected Areas\*  
Map 1 of 1

REFER TO COLMA AND SOUTH SAN FRANCISCO MAP 1



REFER TO DALY CITY AND UNINCORPORATED COUNTY MAP 2

**Cities of Colma and  
South San Francisco  
Hydromodification Management (HM)  
Control Area Boundary for Selected Areas\*  
Map 1 of 1**



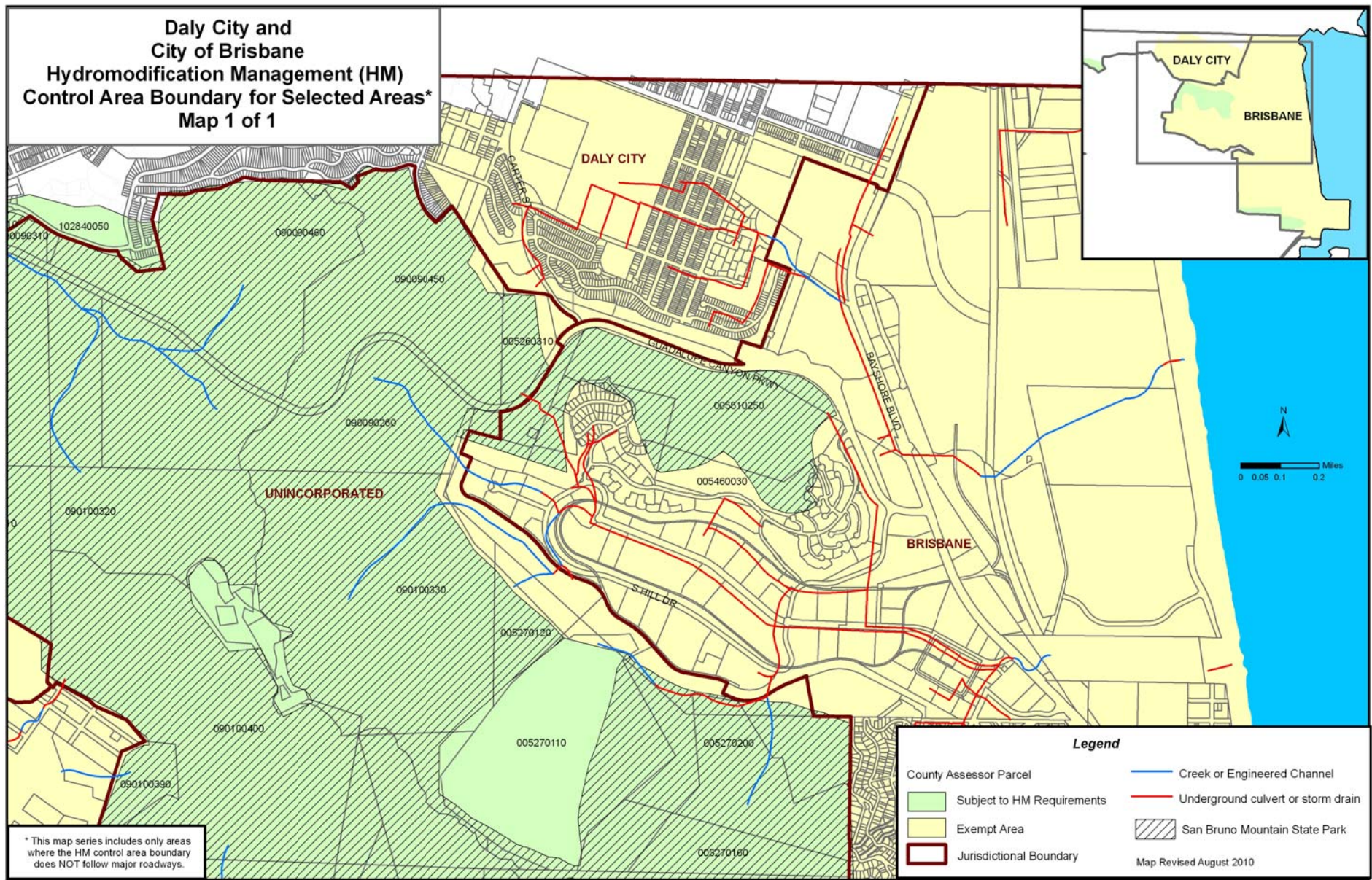
**Legend**

- County Assessor Parcel
  - Subject to HM Requirements
  - Exempt Area
  - Jurisdictional Boundary
  - Creek or Engineered Channel
  - Underground culvert or storm drain
  - San Bruno Mountain State Park
- Map Revised August 2010

\* This map series includes only areas where the HM control area boundary does NOT follow major roadways.

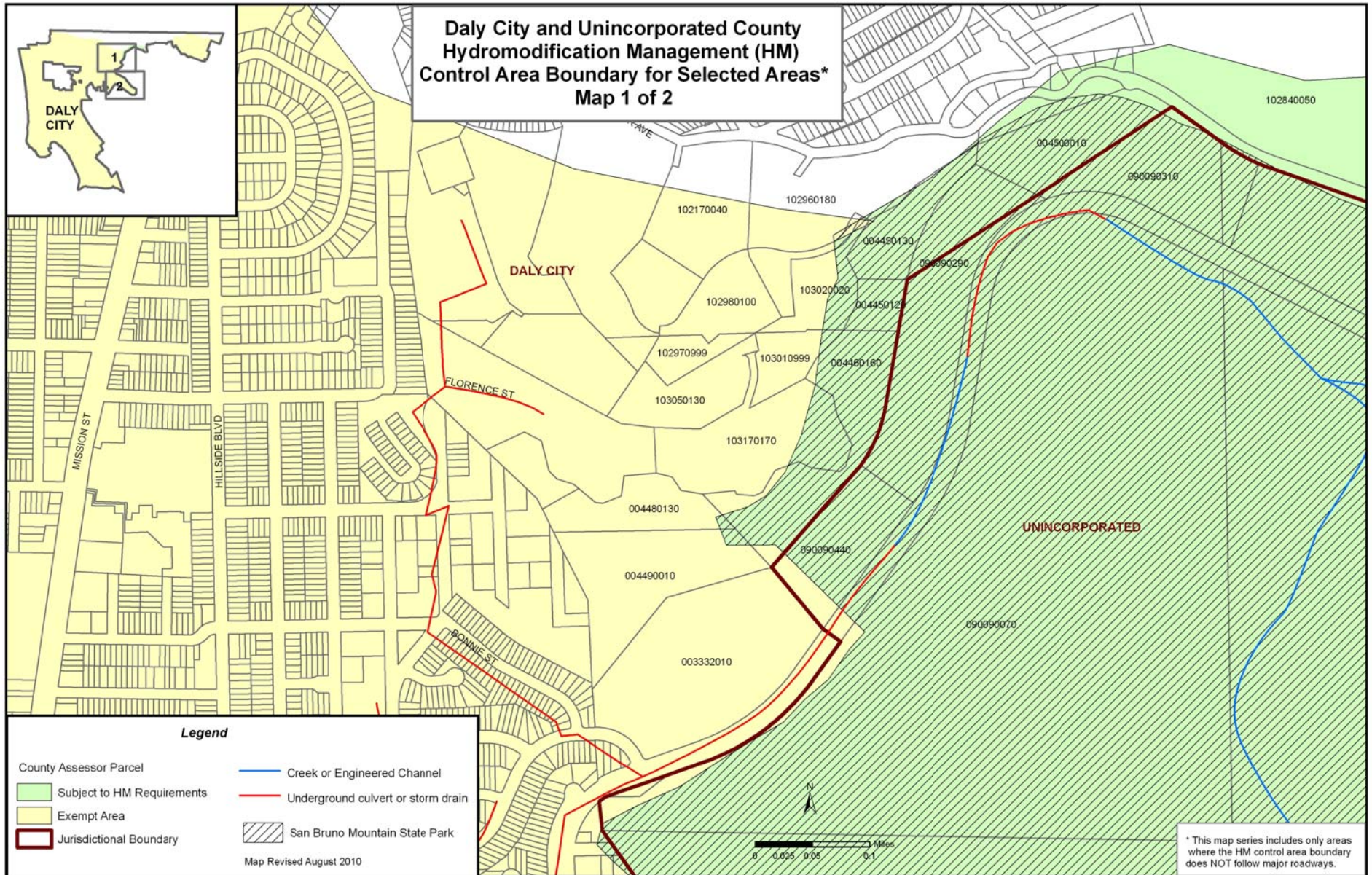
REFER TO SOUTH SAN FRANCISCO AND BRISBANE MAP 1

REFER TO DALY CITY AND UNINCORPORATED COUNTY MAP 1



\* This map series includes only areas where the HM control area boundary does NOT follow major roadways.

REFER TO BRISBANE AND SO. SAN FRANCISCO MAP 1

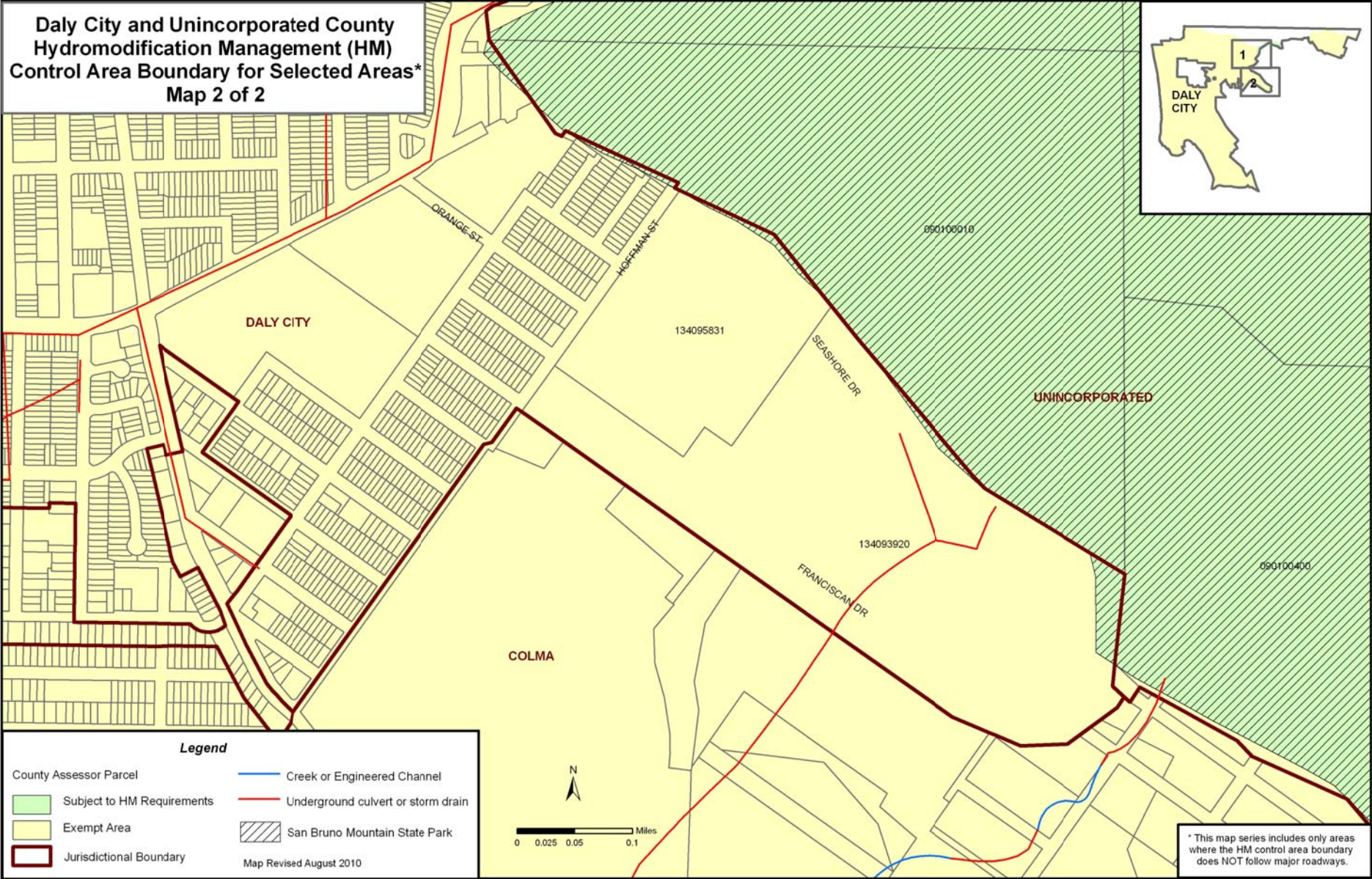


REFER TO DALY CITY AND BRISBANE MAP 1

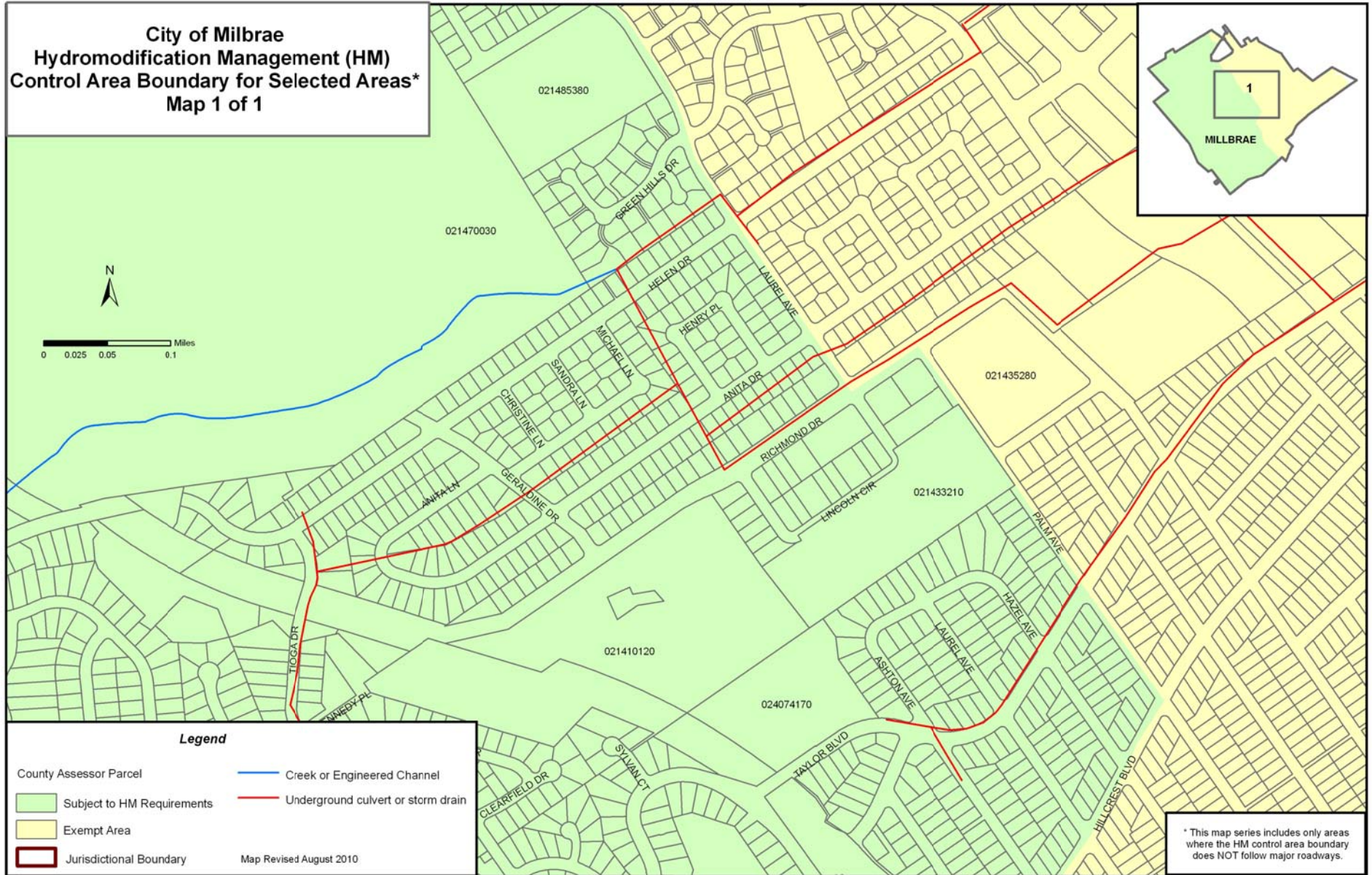
REFER TO DALY CITY AND UNINCORPORATED COUNTY MAP 2



REFER TO DALY CITY AND UNINCORPORATED COUNTY MAP 1



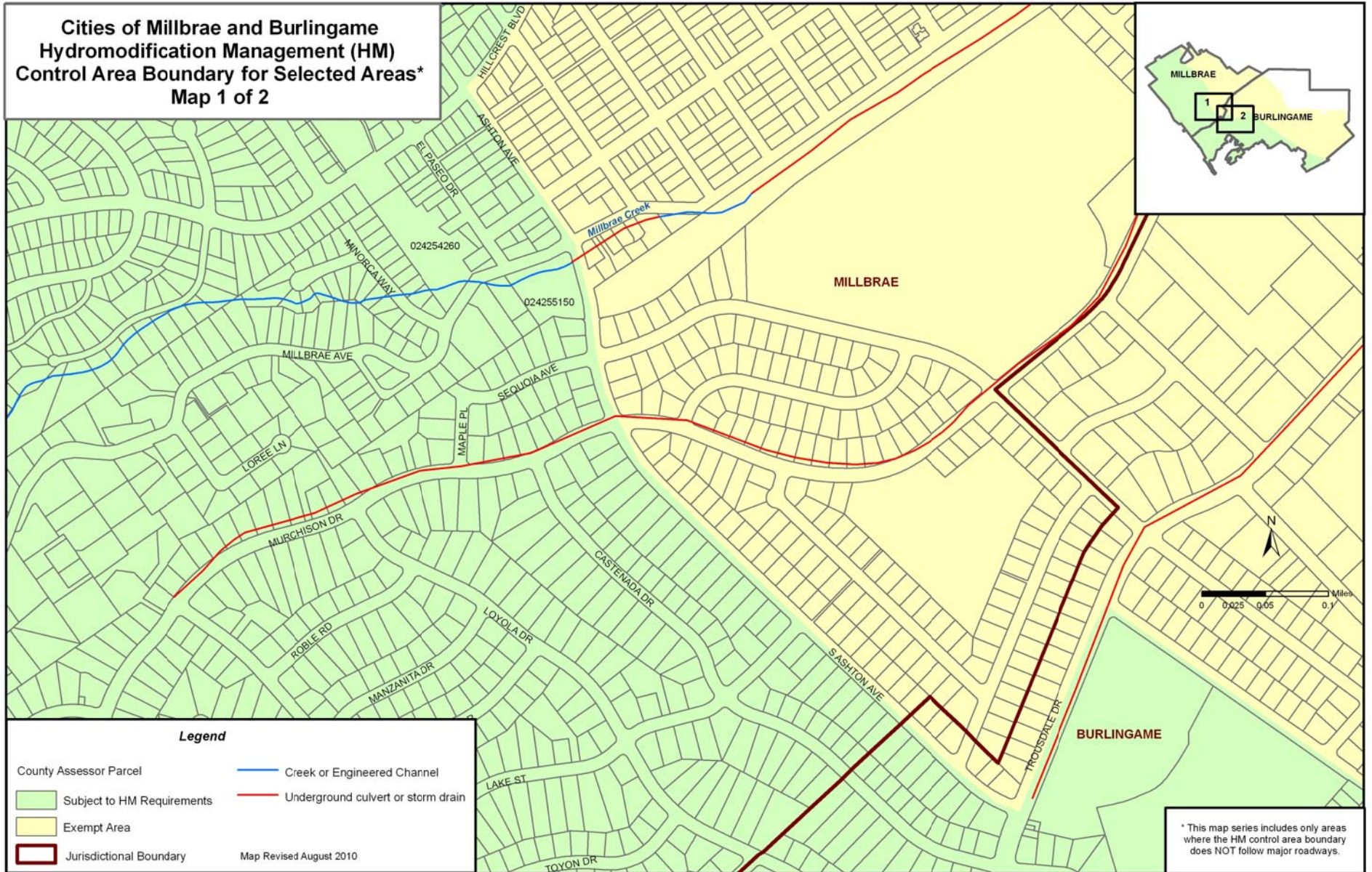
REFER TO SAN BRUNO AND MILLBRAE MAP 2



REFER TO MILLBRAE AND BURLINGAME MAP 1

REFER TO MILLBRAE MAP 1

**Cities of Millbrae and Burlingame  
Hydromodification Management (HM)  
Control Area Boundary for Selected Areas\*  
Map 1 of 2**

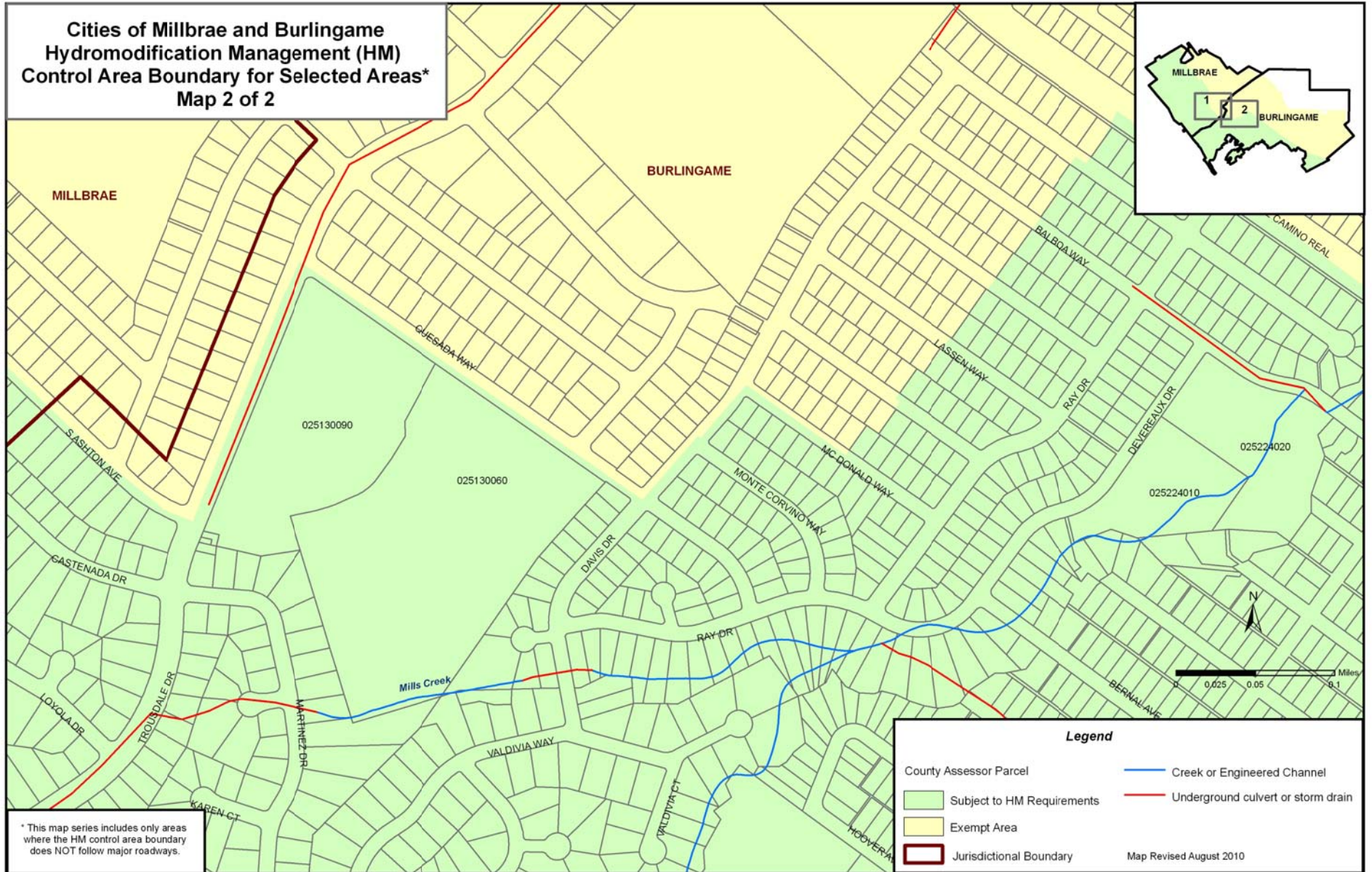


REFER TO MILLBRAE AND BURLINGAME MAP 2

**Cities of Millbrae and Burlingame  
Hydromodification Management (HM)  
Control Area Boundary for Selected Areas\*  
Map 2 of 2**

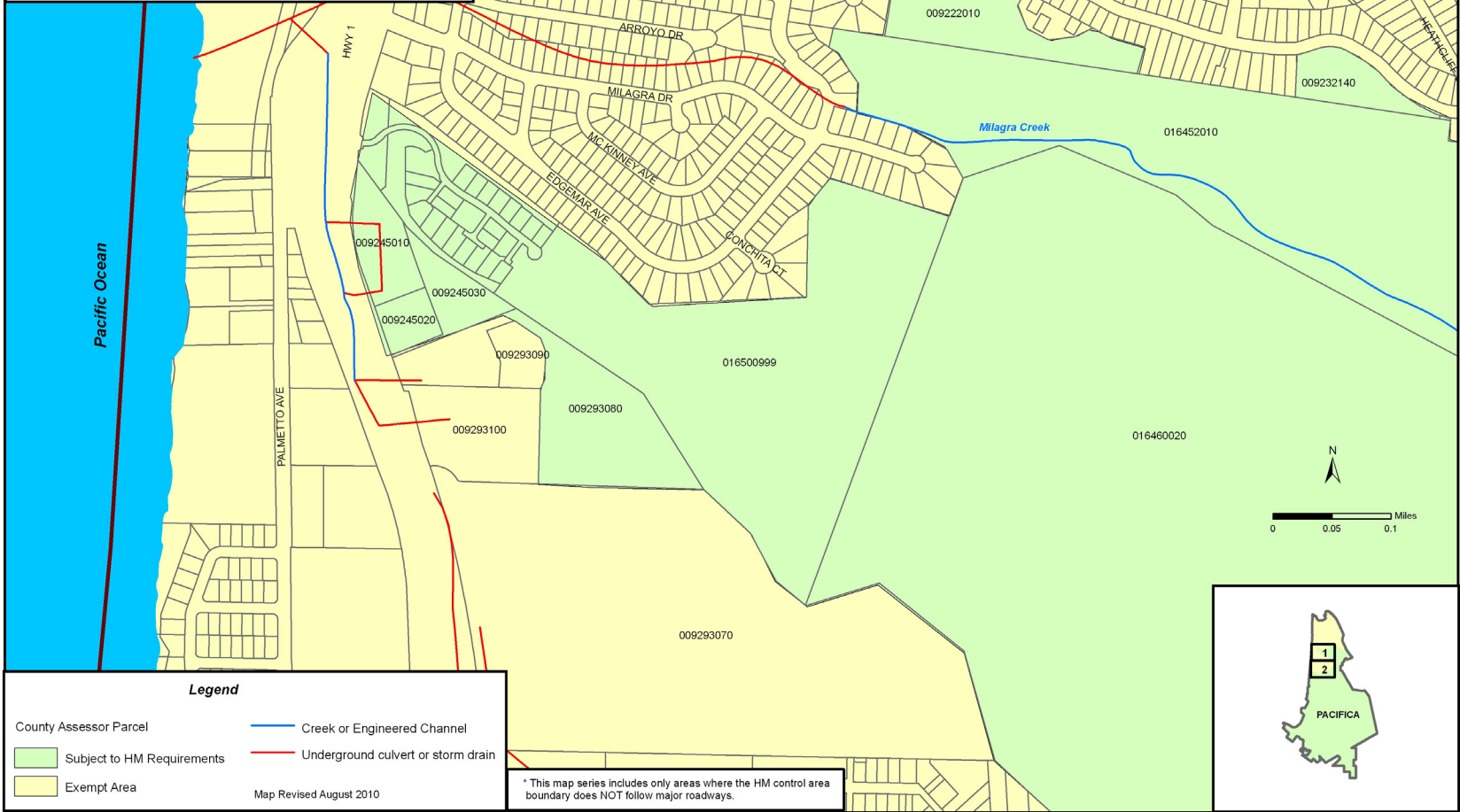


REFER TO MILLBRAE AND BURLINGAME MAP 1



\* This map series includes only areas where the HM control area boundary does NOT follow major roadways.

**City of Pacifica  
Hydromodification Management (HM)  
Control Area Boundary for Selected Areas\*  
Map 1 of 2**



**Legend**

County Assessor Parcel	— Blue line —	Creek or Engineered Channel
Subject to HM Requirements	— Red line —	Underground culvert or storm drain
Exempt Area		

Map Revised August 2010

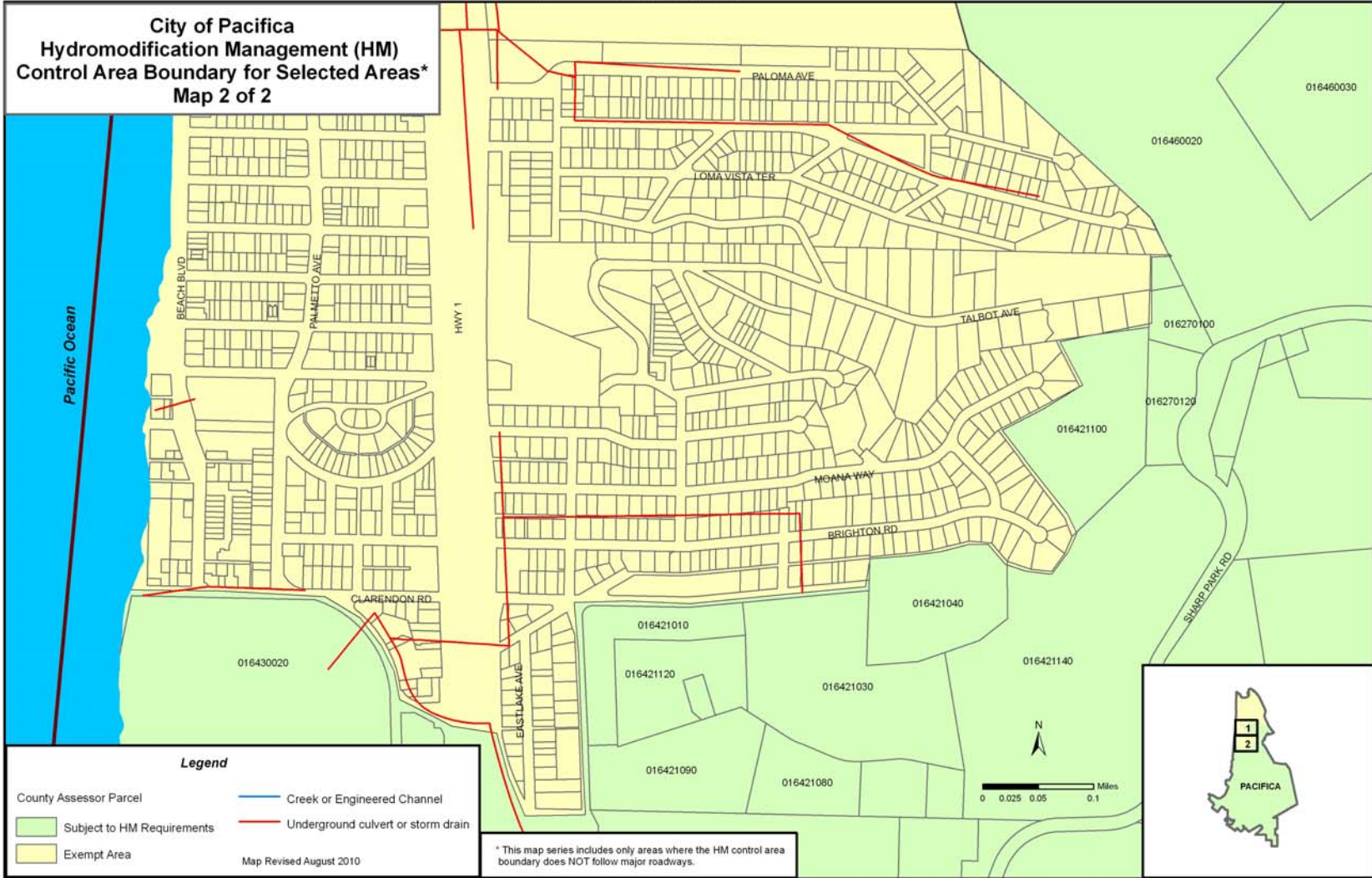
\* This map series includes only areas where the HM control area boundary does NOT follow major roadways.

REFER TO PACIFICA MAP 2

REFER TO PACIFICA, SAN BRUNO AND SOUTH SAN FRANCISCO MAP 1

REFER TO PACIFICA MAP 1

**City of Pacifica  
Hydromodification Management (HM)  
Control Area Boundary for Selected Areas\*  
Map 2 of 2**

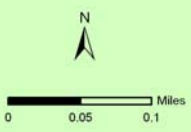
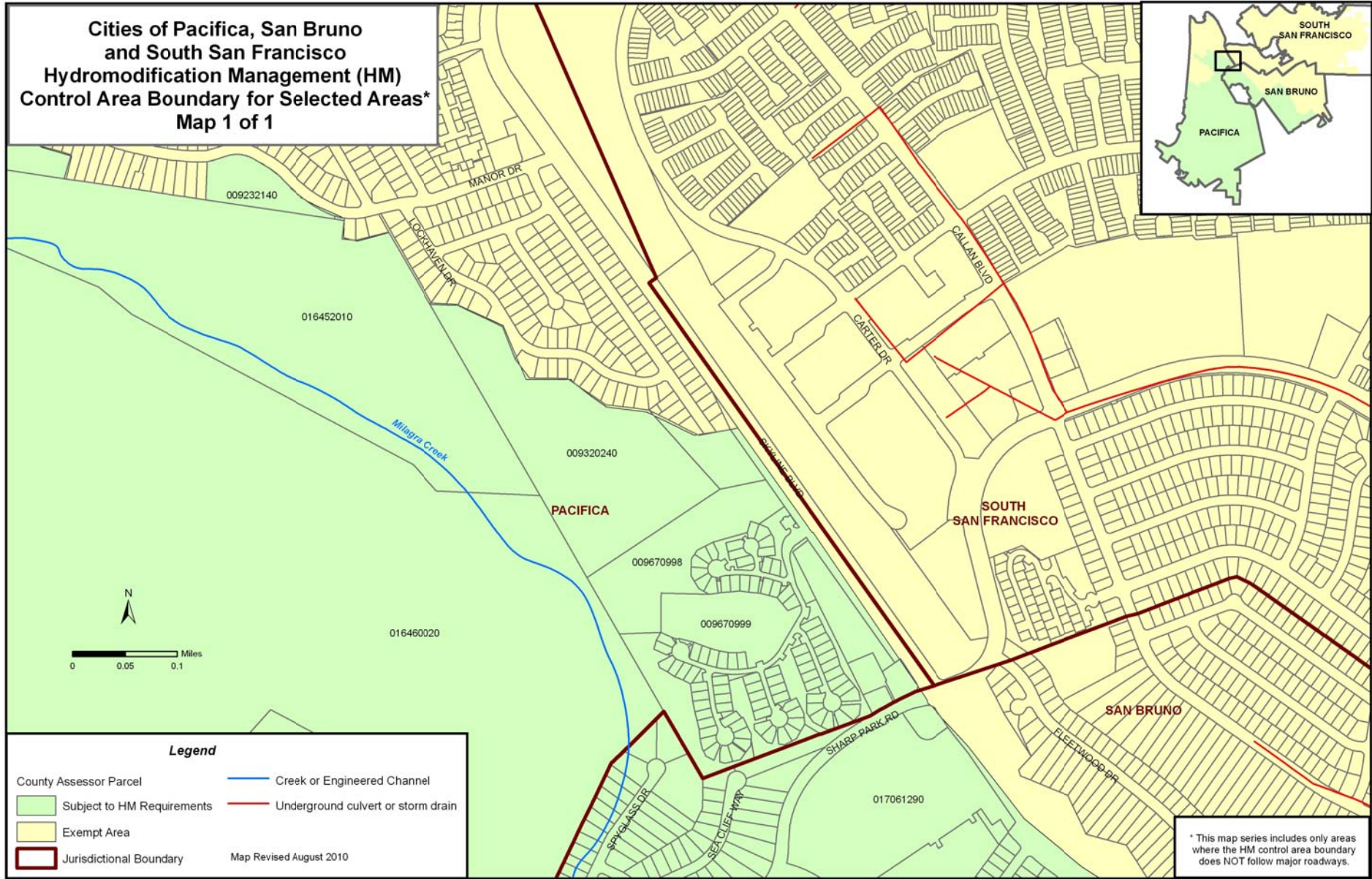


\* This map series includes only areas where the HM control area boundary does NOT follow major roadways.

**Cities of Pacifica, San Bruno  
and South San Francisco  
Hydromodification Management (HM)  
Control Area Boundary for Selected Areas\*  
Map 1 of 1**



REFER TO PACIFICA MAP 1

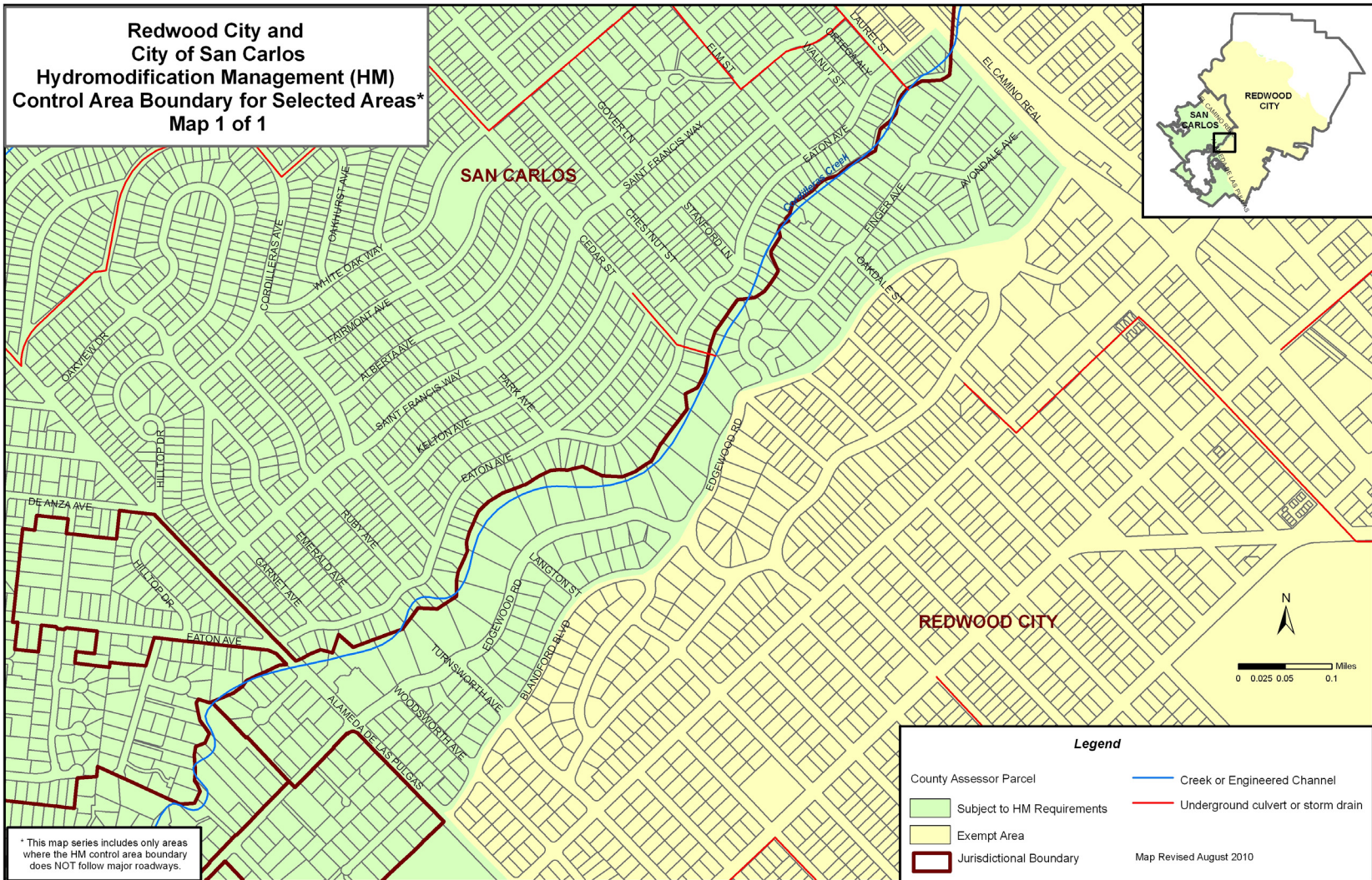


**Legend**

County Assessor Parcel	— Blue —	Creek or Engineered Channel
		Underground culvert or storm drain
		Exempt Area
		Jurisdictional Boundary

Map Revised August 2010

\* This map series includes only areas where the HM control area boundary does NOT follow major roadways.





**Cities of San Bruno and Millbrae  
Hydromodification Management (HM)  
Control Area Boundary for Selected Areas\*  
Map 1 of 2**

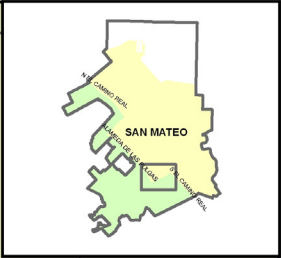


\* This map series includes only areas where the HM control area boundary does NOT follow major roadways.

REFER TO SAN BRUNO AND MILLBRAE MAP 2



**City of San Mateo  
Hydromodification Management (HM)  
Control Area Boundary for Selected Areas\*  
Map 1 of 1**



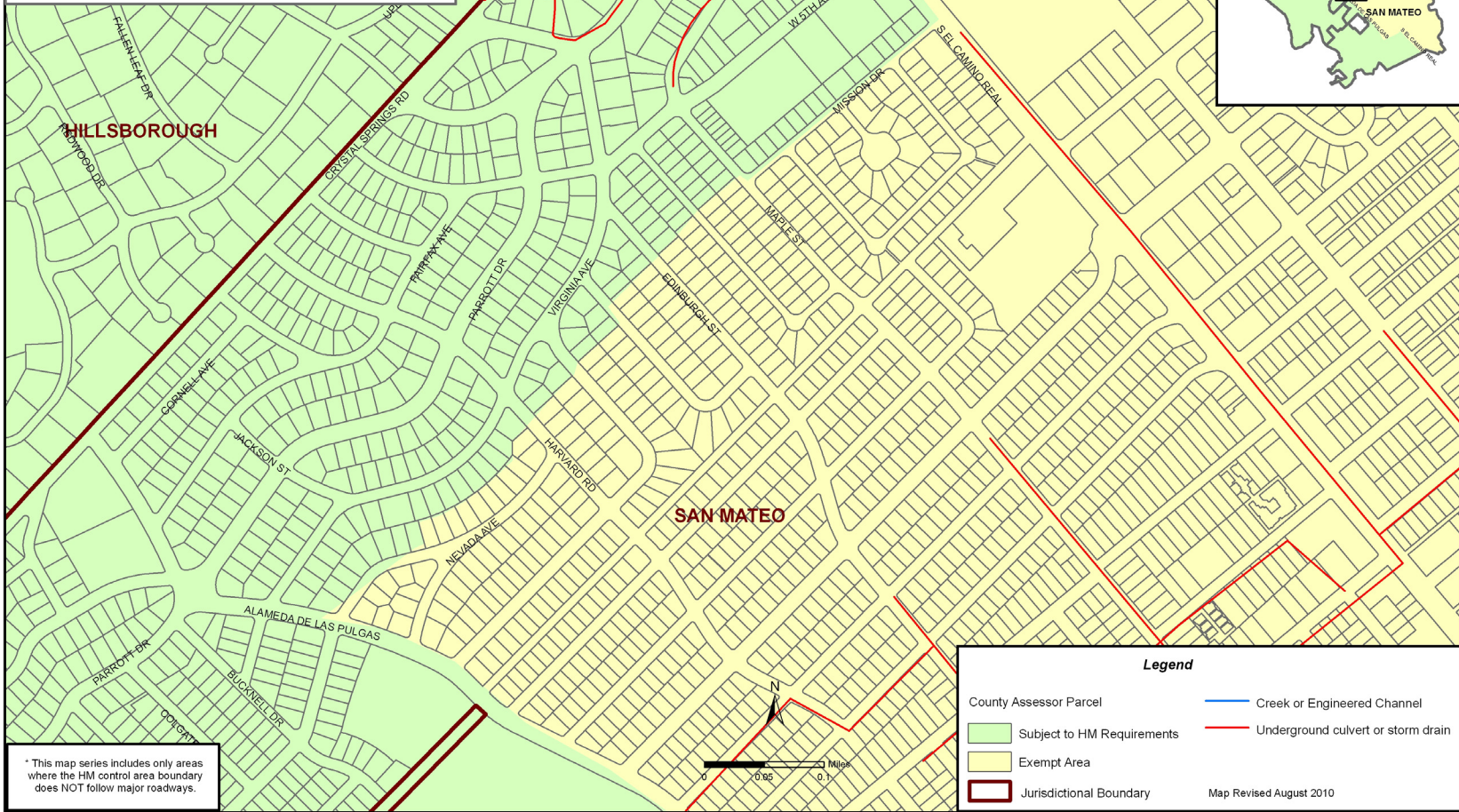
\* This map series includes only areas where the HM control area boundary does NOT follow major roadways.

**Legend**

County Assessor Parcel	Creek or Engineered Channel
Subject to HM Requirements	Underground culvert or storm drain
Exempt Area	
Jurisdictional Boundary	

Map Revised August 2010

**City of San Mateo and Hillsborough  
Hydromodification Management (HM)  
Control Area Boundary for Selected Areas\*  
Map 1 of 1**



\* This map series includes only areas where the HM control area boundary does NOT follow major roadways.

**Legend**

County Assessor Parcel	Creek or Engineered Channel
Subject to HM Requirements	Underground culvert or storm drain
Exempt Area	
Jurisdictional Boundary	Map Revised August 2010

# Appendix I: Guidance on Determining Feasibility and Sizing of Rainwater Harvesting Systems

<i>Introduction</i> .....	I-2
<i>I.1 Rainwater Harvesting/Use Feasibility Guidance</i> .....	I-2
<i>I.2 Determining Feasibility of Rainwater Harvesting and Sizing of Cisterns</i> .....	I-3
<i>I.3 Attachments</i> .....	I-5

## Introduction

The MRP allows development projects to use infiltration, evapotranspiration, harvesting and use, or biotreatment to treat the full water quality design flow or volume of stormwater runoff, as specified in MRP Provision C.3.d. Project applicants are no longer required to evaluate the feasibility of infiltration of rainwater harvesting and use before proceeding to biotreatment.

If a project applicant desires to use rainwater harvesting systems to meet LID treatment requirements, there must be sufficient demand on the project site to use the water quality design volume, i.e., 80 percent of the average annual rainfall runoff, from the collection area. Appendix I provides guidance on how to estimate the required landscaping or toilet flushing demand to meet C.3.d requirements. If the project appears to have sufficient demand for captured rainwater, Appendix I provides guidance on sizing the cistern (or other storage facility) to achieve the appropriate combination of drawdown time and cistern volume.

The information presented in this guidance is based on the “Harvest and Use, Infiltration and Evapotranspiration Feasibility/Infeasibility Criteria Report” (referred to as the “LID Feasibility Report”) prepared by the Bay Area Stormwater Management Agencies Association (BASMAA) and submitted to the Regional Water Board in 2011<sup>56</sup>.

### 1.1 Rainwater Harvesting/Use Feasibility Guidance

Rooftop runoff is the source of stormwater most often collected in a harvesting/use system, because it often contains lower pollutant loads than at-grade surface runoff, and it provides accessible locations for collection in storage facilities via gravity flow.

The 2019 California Plumbing Code effective January 1, 2020 includes rainwater harvesting and graywater requirements, codes, and treatment standards. Chapter 16 of the Plumbing Code, which contains the rainwater harvesting requirements, allows rainwater to be harvested from rooftops for use in outdoor irrigation and some non-potable indoor uses. Rainwater collected from parking lots or other impervious surfaces at or below grade is considered graywater and subject to the water quality requirements for graywater in Chapter 15 of the Code. Some small catchment systems (5,000 gallons or less) being used for non-spray irrigation do not require permits – see Chapter 16 for more details<sup>57</sup>.

The Plumbing Code defines rainwater as “precipitation on any public or private parcel that has not entered an offsite storm drain system or channel, a flood control channel, or any other stream channel, and has not previously been put to beneficial use.”<sup>58</sup> The Rainwater Capture Act of 2012, which took effect January 1, 2013, specifically states that the use of rainwater collected from rooftops does not require a water right permit from the State Water Resources Control Board.

---

<sup>56</sup> This report is available on the Countywide Program’s website ([www.flowstobay.org/newdevelopment](http://www.flowstobay.org/newdevelopment)).

<sup>57</sup> 2019 California Plumbing Code, <https://iapmo.org/publications/read-uniform-codes-online/>. Select CPC 2019 and click on Chapter 16.

<sup>58</sup> 2019 California Plumbing Code, Chapter 2.

## I.2 Determining Feasibility of Rainwater Harvesting and Sizing of Cisterns

A key parameter needed to evaluate the feasibility of using harvested rainwater for irrigation or indoor toilet flushing use is the **Potential Rainwater Capture Area**. This is the impervious area from which rainwater may potentially be captured, if rainwater harvesting and use were implemented for a project. This is typically the roof area of the building(s) draining to the capture facilities.

The text below describes how to determine whether rainwater harvesting may be used to treat the C.3.d amount of runoff on the project site.

**Feasibility of Using Harvested Rainwater for Irrigation.** Harvested rainwater can be used for irrigation in projects that include a considerable amount of landscaping. Follow the steps below to determine if adequate landscaping is available on the project site:

- Calculate the landscaping available on the project site. Note that the landscape area(s) would have to be contiguous and within the same Drainage Management Area to use harvested rainwater for irrigation via gravity flow.
- Refer to Table 11 in Attachment 2 of this guidance, which present ratios of “Effective Irrigated Area to Impervious Area” (EIATIA) for rain gauge areas.
- Determine if the project has sufficient demand for rainwater for use in landscaping, and size the cistern (or other storage facility) to achieve the appropriate combination of drawdown time and cistern volume indicated in the sizing curves included in Attachment 2. Find the page that shows curves corresponding to the closest rain gauge to the project. Any combination of drawdown time and cistern size may be selected that achieves at least 80 percent capture of runoff on the Y-axis of the graphs. Note that the sizing curves are for **1 acre of tributary impervious area**, (i.e., potential rainwater capture area). The resulting cistern volume must be scaled down to the exact size of the project’s rainwater capture area.
- Determine the required demand in gallons per day by dividing the cistern volume by the drawdown time (converted to days).

**Feasibility of Using Harvested Rainwater for Residential Toilet Flushing.** If the project consists entirely of residential use, or if rainwater harvesting is being considered for the residential portion of mixed use projects that include some residential use, then the following steps should be taken:

- Calculate the dwelling units per impervious acre by dividing the number of dwelling units by the acres of the Potential Rainwater Capture Area.
- Refer to Table 3 in Attachment 1 for San Mateo County.
- Identify the number of dwelling units per impervious acre needed in the Rain Gauge Area to provide the toilet flushing demand required for rainwater harvesting.
- If the project appears to have sufficient demand for rainwater, size the cistern (or other storage facility) to achieve the appropriate combination of drawdown time and cistern volume indicated in the sizing curves included in Attachment 2. Find the page that shows curves corresponding to the closest rain gauge to the project. The applicant can select any combination of drawdown time and cistern size that achieves at least 80 percent capture of runoff on the Y-axis of the graphs. Note

that the sizing curves are for 1 acre of tributary impervious area, (i.e., potential rainwater capture area). The resulting cistern volume must be scaled down to the exact size of the project's rainwater capture area.

- Determine the required demand in gallons per day by dividing the cistern volume by the drawdown time (converted to days).

**Commercial/Institutional/Industrial Toilet Flushing.** For projects that consist entirely of commercial, institutional, and/or industrial use, and for the commercial portion of mixed-use projects, follow the following steps:

- Calculate the proposed interior floor area (sq.ft.) per acre of impervious surface by dividing the interior floor area (sq.ft.) by the acres of the Potential Rainwater Capture Area.
- Refer to Table 3 in Attachment 1. This table identifies the required toilet flushing demand based on employees per impervious acre. Identify the square feet of non-residential interior floor area per impervious acre needed in the Rain Gauge Area to provide the toilet flushing demand required for rainwater harvest feasibility.
- If the project appears to have sufficient demand for rainwater, size the cistern (or other storage facility) to achieve the appropriate combination of drawdown time and cistern volume indicated in the sizing curves included in Attachment 2. Find the page that shows curves corresponding to the closest rain gauge to the project. Any combination of drawdown time and cistern size may be selected that achieves at least 80 percent capture of runoff on the Y-axis of the graphs. Note that the sizing curves are for **1 acre of tributary impervious area**, (i.e., potential rainwater capture area). The resulting cistern volume must be scaled down to the exact size of the project's rainwater capture area.
- Determine the required demand in gallons per day by dividing the cistern volume by the drawdown time (converted to days).

**School Toilet Flushing.** For school projects, follow the following steps:

- Calculate the proposed interior floor area (sq.ft.) per acre of impervious surface by dividing the interior floor area (sq.ft.) by the acres of the Potential Rainwater Capture Area.
- Refer to Table 3 in Attachment 1, which identifies the required toilet flushing demand based on employees per impervious acre.
- If the project appears to have sufficient demand for rainwater, size the cistern (or other storage facility) to achieve the appropriate combination of drawdown time and cistern volume indicated in the sizing curves included in Attachment 2. Find the page that shows curves corresponding to the closest rain gauge to the project. Any combination of drawdown time and cistern size may be selected that achieves at least 80 percent capture of runoff on the Y-axis of the graphs. Note that the sizing curves are for **1 acre of tributary impervious area**, (i.e., potential rainwater capture area). The resulting cistern volume must be scaled down to the exact size of the project's rainwater capture area.
- Determine the required demand in gallons per day by dividing the cistern volume by the drawdown time (converted to days).



**Mixed Commercial and Residential Use Projects.** The following steps should be followed for mixed use projects:

- Evaluate the residential toilet flushing demand based on the dwelling units per impervious acre for the residential portion of the project, following the instructions above, except using a prorated acreage of impervious surface, based on the percentage of the project dedicated to residential use.
- Evaluate the commercial toilet flushing demand per impervious acre for the commercial portion of the project, following the instructions above, except using a prorated acreage of impervious surface, based on the percentage of the project dedicated to commercial use.
- If the project appears to have sufficient demand for rainwater, size the cistern (or other storage facility) to achieve the appropriate combination of drawdown time and cistern volume indicated in the sizing curves included in Attachment 2. Find the page that shows curves corresponding to the closest rain gauge to the project. Any combination of drawdown time and cistern size may be selected that achieves at least 80 percent capture of runoff on the Y-axis of the graphs. Note that the sizing curves are for **1 acre of tributary impervious area**, (i.e., potential rainwater capture area). The resulting cistern volume must be scaled down to the exact size of the project's rainwater capture area.
- Determine the required demand in gallons per day by dividing the cistern volume by the drawdown time (converted to days).

**Industrial Projects.** Follow the steps below for industrial projects:

- If the project will include an industrial processing use for non-potable water, identify the demand for this use.
- Refer to Table 9 in Attachment 2. This Table identifies demand based on the required cistern volume and demand, for the maximum allowable drawdown time, to capture the C.3.d amount of runoff.
- If the project appears to have sufficient demand for rainwater, size the cistern (or other storage facility) to achieve the appropriate combination of drawdown time and cistern volume indicated in the sizing curves included in Attachment 2. Find the page that shows curves corresponding to the closest rain gauge to the project. Any combination of drawdown time and cistern size may be selected that achieves at least 80 percent capture of runoff on the Y-axis of the graphs. Note that the sizing curves are for **1 acre of tributary impervious area**, (i.e., potential rainwater capture area). The resulting cistern volume must be scaled down to the exact size of the project's rainwater capture area.
- Determine the required demand in gallons per day by dividing the cistern volume by the drawdown time (converted to days).

## I.3 Attachments

The following pages include the attachments listed below.

- Attachment 1: Toilet-Flushing Demand for Harvested Rainwater
- Attachment 2: Excerpts from the Feasibility Report (Map of Soil Hydraulic Conductivity and Rain Gauge Areas, Tables 8 through 11, and Figures F-8, F-9, and F-10 from the report's Appendix F)

Appendix I

Attachment 1: Toilet-Flushing Demand Required for Rainwater Harvesting Feasibility per Impervious Acre (IA) <sup>1,2</sup>

Table 1 - Alameda County:

Rain Gauge <sup>3</sup>	Required Demand (gal/day/IA) <sup>4</sup>	Residential		Office/Retail <sup>5</sup>		Schools <sup>6</sup>	
		No. of residents per IA <sup>7</sup>	Dwelling Units per IA <sup>8</sup>	Employees per IA <sup>9</sup>	Interior Floor Area (sq.ft./IA) <sup>10</sup>	Employees <sup>11</sup> per IA	Interior Floor Area (sq.ft./IA) <sup>12</sup>
Berkeley	5,900	690	255	860	172,000	170	51,000
Dublin	4,100	480	177	590	118,000	120	36,000
Hayward	4,800	560	207	700	140,000	140	42,000
Palo Alto	2,900	340	125	420	84,000	90	27,000
San Jose	2,400	280	103	350	70,000	70	21,000

Table 2 - Santa Clara County:

Rain Gauge <sup>3</sup>	Required Demand (gal/day/IA) <sup>4</sup>	Residential		Office/Retail <sup>5</sup>		Schools <sup>6</sup>	
		No. of residents per IA <sup>7</sup>	Dwelling Units per IA <sup>8</sup>	Employees per IA <sup>9</sup>	Interior Floor Area (sq.ft./IA) <sup>10</sup>	Employees <sup>11</sup> per IA	Interior Floor Area (sq.ft./IA) <sup>12</sup>
Morgan Hill	6,500	760	260	940	188,000	190	57,000
Palo Alto	2,900	340	116	420	84,000	90	27,000
San Jose	2,400	280	96	350	70,000	70	21,000

Table 3 – San Mateo County:

Rain Gauge <sup>3</sup>	Required Demand (gal/day/IA) <sup>4</sup>	Residential		Office/Retail <sup>5</sup>		Schools <sup>6</sup>	
		No. of residents per IA <sup>7</sup>	Dwelling Units per IA <sup>8</sup>	Employees per IA <sup>9</sup>	Interior Floor Area (sq.ft./IA) <sup>10</sup>	Employees <sup>11</sup> per IA	Interior Floor Area (sq.ft./IA) <sup>12</sup>
Palo Alto	2,900	340	124	420	84,000	90	27,000
San Francisco	4,600	530	193	670	134,000	140	42,000
SF Oceanside	4,300	500	182	620	124,000	130	39,000

## Appendix I

**Table 4 – Contra Costa County:**

Rain Gauge <sup>3</sup>	Required Demand (gal/day/IA) <sup>4</sup>	Residential		Office/Retail <sup>5</sup>		Schools <sup>6</sup>	
		No. of residents per IA <sup>7</sup>	Dwelling Units per IA <sup>8</sup>	Employees per IA <sup>9</sup>	Interior Floor Area (sq.ft./IA) <sup>10</sup>	Employees <sup>11</sup> per IA	Interior Floor Area (sq.ft./IA) <sup>12</sup>
Berkeley	5,900	690	254	860	172,000	170	51,000
Brentwood	4,200	490	180	610	122,000	120	36,000
Dublin	4,100	480	176	590	118,000	120	36,000
Martinez	5,900	690	254	860	172,000	170	51,000

**Table 5 – Solano County:**

Rain Gauge <sup>3</sup>	Required Demand (gal/day/IA) <sup>4</sup>	Residential		Office/Retail <sup>5</sup>		Schools <sup>6</sup>	
		No. of residents per IA <sup>7</sup>	Dwelling Units per IA <sup>8</sup>	Employees per IA <sup>9</sup>	Interior Floor Area (sq.ft./IA) <sup>10</sup>	Employees <sup>11</sup> per IA	Interior Floor Area (sq.ft./IA) <sup>12</sup>
Lake Solano	9,000	1,050	362	1,300	260,000	270	81,000
Martinez	5,900	690	238	860	172,000	170	51,000

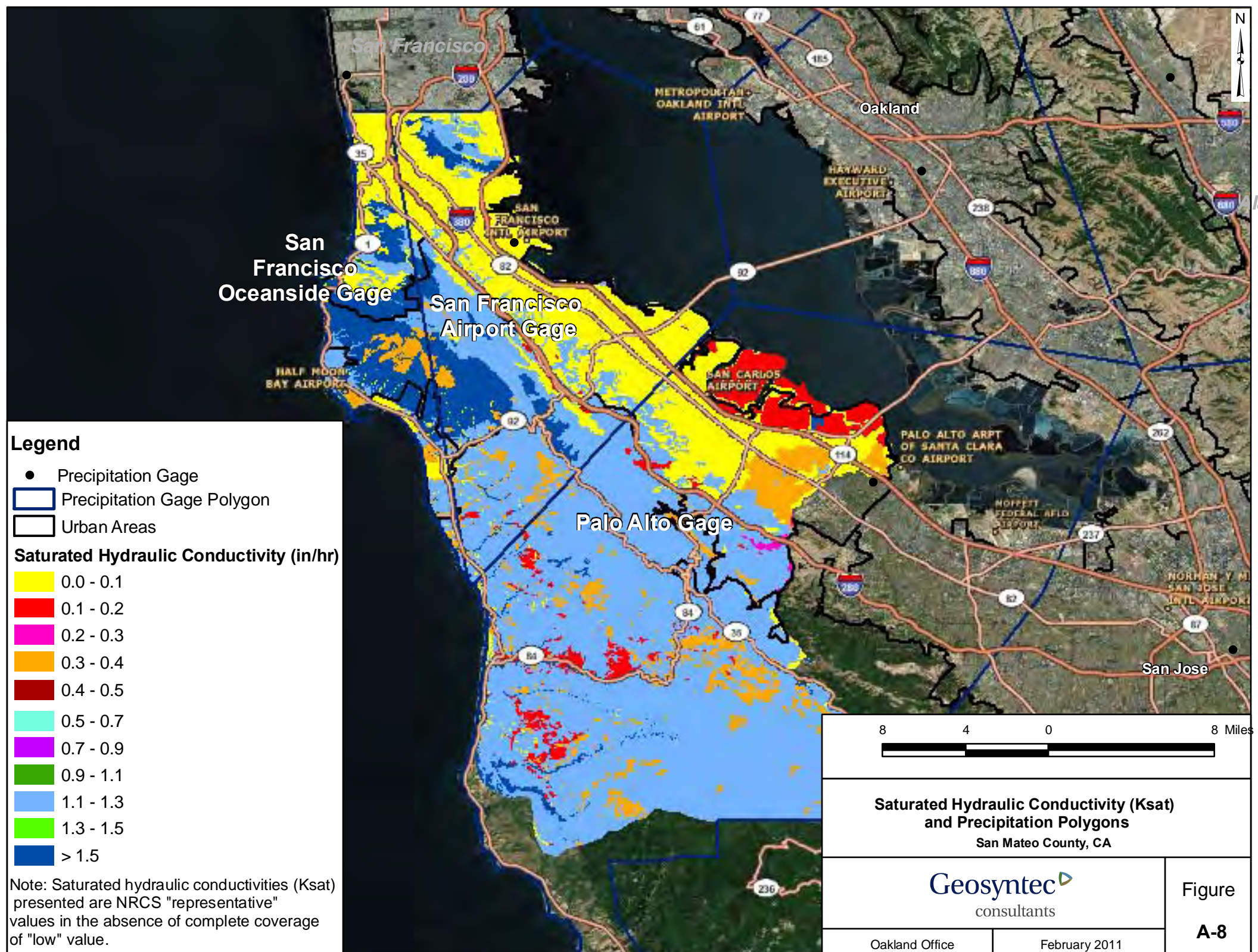
**Notes:**

1. Demand thresholds obtained from the “Harvest and Use, Infiltration and Evapotranspiration Feasibility/Infeasibility Criteria Report” (LID Feasibility Report) submitted to the Regional Water Board on May 1, 2011.
2. Toilet flushing demands assume use of low flow toilets per the California Green Building Code.
3. See Attachment 3 to identify the rain gauge that corresponds to the project site.
4. Required demand per acre of impervious area to achieve 80% capture of the C.3.d runoff volume with the maximum allowable drawdown time for cistern of 50,000 gallons or less, from Table 9 of the LID Feasibility Report.
5. “Office/Retail” includes the following land uses: office or public buildings, hospitals, health care facilities, retail or wholesale stores, and congregate residences.
6. “Schools” includes day care, elementary and secondary schools, colleges, universities, and adult centers.
7. Residential toilet flushing demand identified in Table 10 of the LID Feasibility Report.
8. Residential toilet flushing demand divided by the countywide average number of persons per household (US Census data reported on [www.abag.org](http://www.abag.org)), as follows: Alameda County: 2.71 persons per household; Santa Clara County: 2.92; San Mateo County: 2.74; Contra Costa County: 2.72; Solano County: 2.90.
9. Office/retail employee toilet flushing demand identified in Table 10 of the LID Feasibility Report.
10. Interior floor area required for rainwater harvest and use feasibility per acre of impervious area is based on the number of employees in Column 5 multiplied by an occupant load factor of 200 square feet per employee (reference: 2010 California Plumbing Code, Chapter 4, Plumbing Fixtures and Fitting Fixtures, Table A, page 62.)
11. School employee toilet flushing demand identified in Table 10 of the LID Feasibility Report. Each school employee represents 1 employee and 5 “visitors” (students and others).
12. Interior floor area required for rainwater harvest and use feasibility per acre of impervious area is based on the number of employees in Column 7 multiplied by 6 to account for visitors, then multiplied by an occupant load factor of 50 square feet per employee (reference: 2010 California Plumbing Code).

## Appendix I

### **Attachment 2: Excerpts from BASMAA's Feasibility/Infeasibility Report**

- Figure A-8: Saturated Hydraulic Conductivity (Ksat) and Precipitation Polygons, San Mateo County, CA
- Table 8: Required Cistern Volume and Demand per Acre of Impervious Area to Achieve 80% Capture with a 48-hour Drawdown Time
- Table 9: Required Cistern Volume and Demand per Acre of Impervious Area to Achieve 80% Capture with the Longer Drawdown Time Allowable (Minimum Demand) for Cistern of 50,000 Gallons or Less
- Table 10: TUTIA Ratios for Typical Land Uses for Rain Gauges Analyzed
- Table 11: EIATIA Ratios for Rain Gauges Analyzed
- Figure F-8: Percent Capture Achieved by BMP Storage Volume with Various Drawdown Times for 1-Acre, 100% Impervious Tributary Area: Palo Alto
- Figure F-9: Percent Capture Achieved by BMP Storage Volume with Various Drawdown Times for 1-Acre, 100% Impervious Tributary Area: San Francisco Airport
- Figure F-10: Percent Capture Achieved by BMP Storage Volume with Various Drawdown Times for 1-Acre, 100% Impervious Tributary Area: San Francisco Oceanside



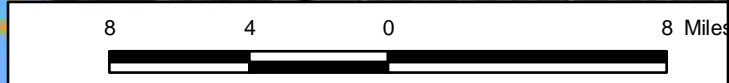
**Legend**

- Precipitation Gage
- ▭ Precipitation Gage Polygon
- ▭ Urban Areas

**Saturated Hydraulic Conductivity (in/hr)**

- 0.0 - 0.1
- 0.1 - 0.2
- 0.2 - 0.3
- 0.3 - 0.4
- 0.4 - 0.5
- 0.5 - 0.7
- 0.7 - 0.9
- 0.9 - 1.1
- 1.1 - 1.3
- 1.3 - 1.5
- > 1.5

Note: Saturated hydraulic conductivities (Ksat) presented are NRCS "representative" values in the absence of complete coverage of "low" value.



**Saturated Hydraulic Conductivity (Ksat) and Precipitation Polygons**  
San Mateo County, CA

		<p>Figure <b>A-8</b></p>
Oakland Office	February 2011	

**Table 8: Required Cistern Volume and Demand per Acre of Impervious Area to Achieve 80% Capture with a 48-hour Drawdown Time**

Rain Gauge	Drawdown Time (hr.)	Required Cistern Size (gallons)	Required Demand (gal/day)
Berkeley	48	23,000	11,500
Brentwood	48	19,000	9,500
Dublin	48	21,000	10,500
Hayward	48	23,500	11,750
Lake Solano	48	29,000	14,500
Martinez	48	23,000	11,500
Morgan Hill	48	25,500	12,750
Palo Alto	48	16,500	8,250
San Francisco	48	20,000	10,000
San Francisco Oceanside	48	19,000	9,500
San Jose	48	15,000	7,500

If a longer drawdown time (and lower minimum demand) is desired, Table 9 includes the maximum drawdown time allowable to achieve 80 percent capture for a cistern sized at 50,000 gallons or less per acre of impervious area, along with the required cistern sizes and daily demands.

**Table 9: Required Cistern Volume and Demand per Acre of Impervious Area to Achieve 80% Capture with the Longer Drawdown Time Allowable (Minimum Demand) for Cistern of 50,000 Gallons or Less**

Rain Gauge	Drawdown Time (hr.)	Required Cistern Size (gallons)	Required Demand (gal/day)
Berkeley	180	44,000	5,900
Brentwood	240	42,000	4,200
Dublin	240	41,000	4,100
Hayward	240	47,500	4,800
Lake Solano	120	45,000	9,000
Martinez	180	44,000	5,900
Morgan Hill	180	49,000	6,500
Palo Alto	360	44,000	2,900
San Francisco	240	45,500	4,600
San Francisco Oceanside	240	43,000	4,300
San Jose	480	48,000	2,400

**Table 10: TUTIA Ratios for Typical Land Uses for Rain Gauges Analyzed**

Rain Gauge	Required Demand <sup>1</sup> (gal/day)	Toilet Users per Impervious Acre (TUTIA) <sup>2</sup>							
		Residential		Office/Retail		Schools		Industrial	
		Current	CGBC <sup>3</sup>	Current	CGBC	Current	CGBC	Current	CGBC
Assumed Per Capita Use per Day (gal/day) <sup>4</sup>		18	8.6	14	6.9	66	34	11	5.4
Berkeley	5,900	320	690	420	860	90	170	540	1,090
Brentwood	4,200	230	490	300	610	60	120	380	780
Dublin	4,100	220	480	290	590	60	120	370	760
Hayward	4,800	260	560	340	700	70	140	440	890
Lake Solano	9,000	490	1050	640	1,300	140	270	820	1,670
Martinez	5,900	320	690	420	860	90	170	540	1090
Morgan Hill	6,500	350	760	460	940	100	190	590	1,200
Palo Alto	2,900	160	340	210	420	40	90	260	540
San Francisco	4,600	250	530	330	670	70	140	420	850
San Francisco Oceanside	4,300	230	500	310	620	70	130	390	800
San Jose	2,400	130	280	170	350	40	70	220	440

Footnotes:

<sup>1</sup> For a 50,000 or less gallon tank to achieve 80 percent capture within maximum allowable drawdown time (Table 9).

<sup>2</sup> The TUTIA ratios are based on employee toilet users per impervious acre. These ratios were calculated using the daily toilet and urinal water usage from Table 5, which are per employee and encompass usage by visitors and students within the daily demand (assumes about 5 students per school employee).

<sup>3</sup> CGBC = California Green Building Code Requirements water usage accounting for water conservation.

<sup>4</sup> From Table 5, Toilet and Urinal Water Usage per Resident or Employee.

*EIATA Ratios*

Comparing the required daily demands for rainwater harvesting systems for both 48-hour drawdown times and maximum drawdown times to daily demands per irrigated acre, it becomes evident that the required demands are many times larger than irrigation demands. This can be translated into an ‘Effective Irrigated Area to Impervious Area’ (EIATIA) ratio by dividing the required rainwater harvesting system demand by the daily irrigation demand (shown in Table 7). Since both demands are calculated on a per acre basis, the EIATIA ratio represents the number of acres of irrigated area needed per acre of impervious surface to meet the demand needed for 80 percent capture. EIATIA ratios were analyzed for the rain gauges used for analysis and the evapotranspiration data listed in Table F-1. These ratios, as well as the required total imperviousness (assuming a project includes the impervious tributary area and the irrigated area only) are included in Table 11.

**Table 11: EIATIA Ratios for Rain Gauges Analyzed**

Rain Gauge	Required Daily Demand <sup>1</sup> (gal/day)	ET Data Location <sup>2</sup>	Conservation Landscaping			Turf Areas		
			Demand per Irrigated Acre <sup>3</sup>	EIATIA	Resultant Imperviousness (%)	Demand per Irrigated Acre <sup>3</sup>	EIATIA	Resultant Imperviousness (%)
Berkeley	5,900	Oakland	420	14.0	7%	850	6.9	13%
Brentwood	4,200	Brentwood	420	10.0	9%	850	4.9	17%
Dublin	4,100	Pleasanton	430	9.5	9%	850	4.8	17%
Hayward	4,800	Fremont	520	9.2	10%	1,040	4.6	18%
Lake Solano	9,000	Fairfield	420	21.4	4%	840	10.7	9%
Martinez	5,900	Martinez	380	15.5	6%	760	7.8	11%
Morgan Hill	6,500	Morgan Hill	500	13.0	7%	1,000	6.5	13%
Palo Alto	2,900	Redwood City	450	6.4	13%	900	3.2	24%
San Francisco	4,600	San Francisco	360	12.8	7%	720	6.4	14%
San Francisco Oceanside	4,300	San Francisco	360	11.9	8%	720	6.0	14%
San Jose	2,400	San Jose	470	5.1	16%	940	2.6	28%

**Footnotes:**

<sup>1</sup> To achieve 80 percent capture within maximum allowable drawdown time (Table 9).

<sup>2</sup> Closest location selected, from Table F-1.

<sup>3</sup> From Table 7.

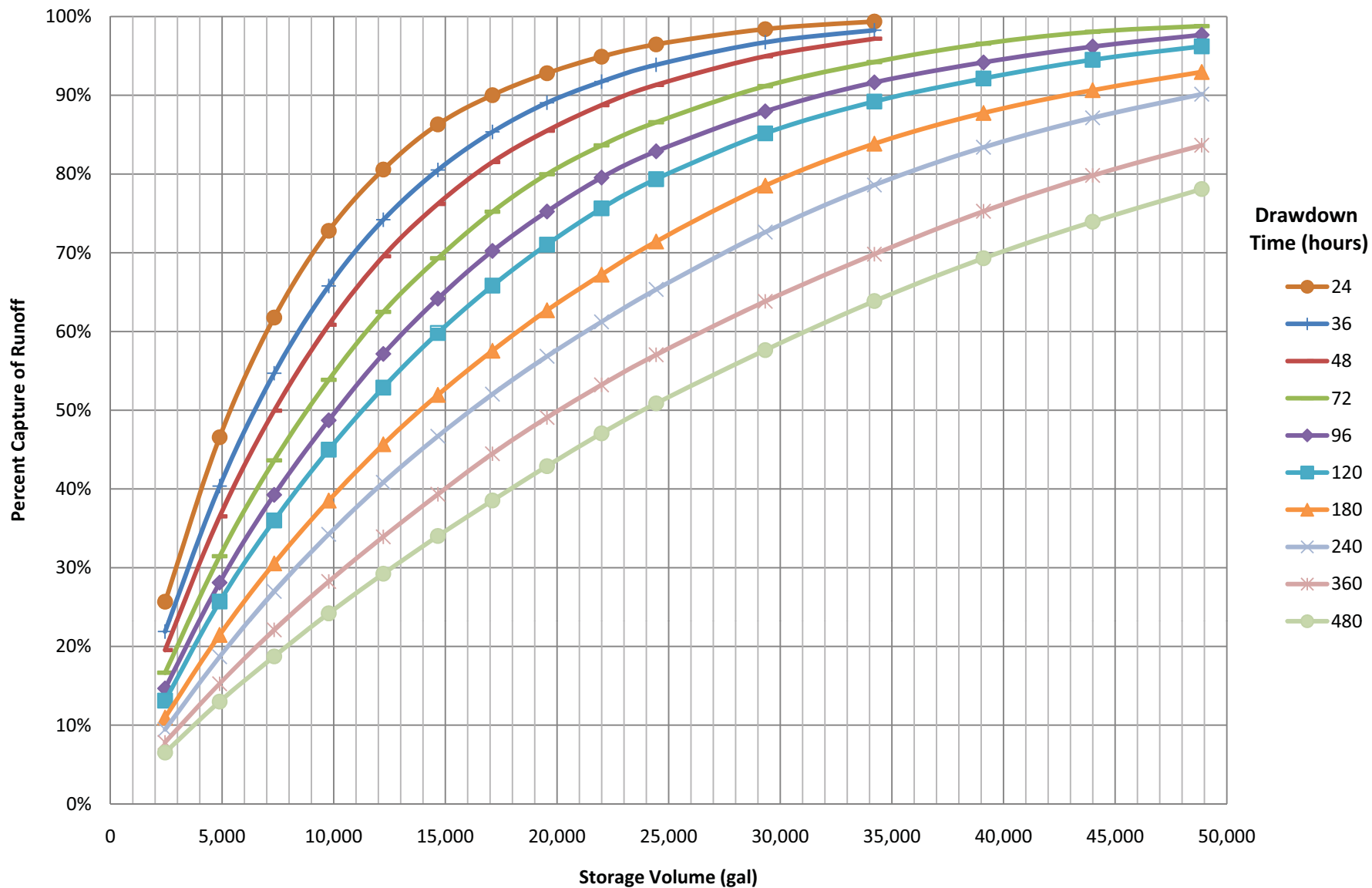
### 3.3.3 Summary

In summary, TUTIA ratios indicate that dense land uses would be required to provide the needed demand to make rainwater harvesting feasible in the MRP area. A project must have sufficiently high toilet flushing uses to achieve 80 percent capture within the maximum allowable drawdown time (see Table 9 for maximum allowable drawdown time for a 50,000 gallon tank or less). For instance, approximately 280 to 1,050 residential toilet users (roughly 90 – 130 dwelling units per acre<sup>5</sup>) are required, depending on location, per impervious acre to meet the demand needed for 80 percent capture with the maximum allowable drawdown time and CA Green Building Code flush requirements. Meeting the demand requirements would entail a very dense housing

<sup>5</sup> Assuming three residents per dwelling unit.

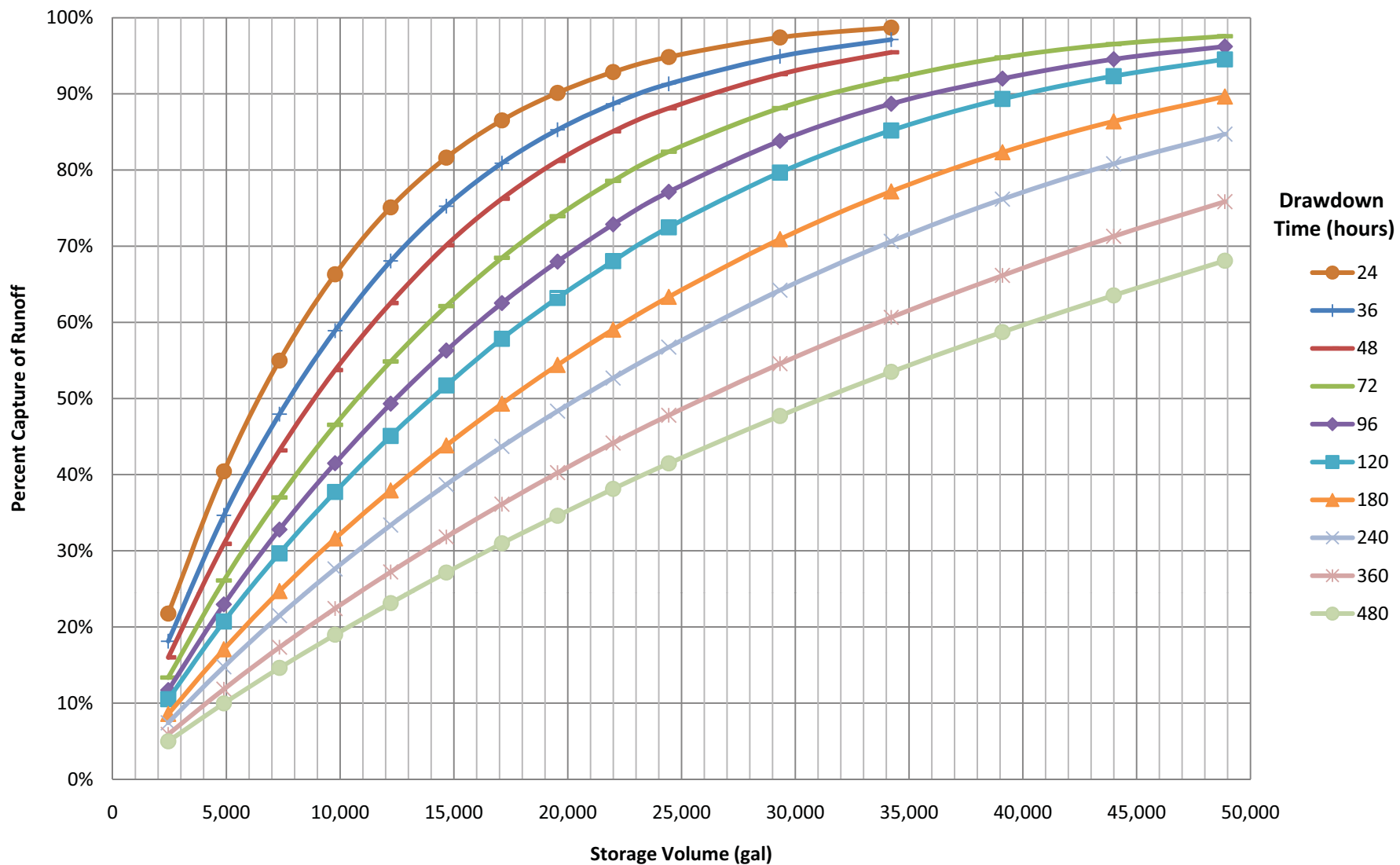


**Figure F-8: Percent Capture Achieved by BMP Storage Volume with Various Drawdown Times for 1-Acre, 100% Impervious Tributary Area - Palo Alto**





**Figure F-10: Percent Capture Achieved by BMP Storage Volume with Various Drawdown Times for 1-Acre, 100% Impervious Tributary Area- San Francisco Oceanside**



# Appendix J: Special Projects

<i>Introduction</i> .....	J-2
<i>J.1 Category A: Small Infill Projects</i> .....	J-2
<i>J.2 Category B: Larger Infill Projects</i> .....	J-3
<i>J.3 Category C: Affordable Housing Projects</i> .....	J-5
<i>J.4 Calculating the LID Treatment Reduction Credit (Special Projects Worksheet)</i> .....	J-9
<i>J.5 Applying the LID Treatment Reduction Credits to Special Projects</i> .....	J-9
<i>J.6 LID Infeasibility Requirement for Special Projects</i> .....	J-9

## Introduction

On November 28, 2011, the San Francisco Bay Regional Water Quality Control Board (Water Board) amended the MRP to allow LID treatment reduction credits for three categories of “Smart Growth” development, specifically urban infill, high-density, and transit-oriented development projects, called “Special Projects”. The reissuance of the MRP on May 11, 2022, eliminated the transit-oriented development category and replaced it with an affordable housing category. Effective July 1, 2023, “Special Projects” include urban infill, high density, and affordable housing development projects. On October 11, 2023, the MRP was amended to include different criteria for assessing LID treatment reduction credits for the affordable housing category, and these criteria became effective on November 1, 2023.

LID treatment reduction credits are allowed for Special Projects because, when considered at the watershed scale, these types of development projects can either reduce existing impervious surfaces or create less “accessory” impervious areas and automobile-related pollutant impacts, and thus these types of projects were recognized by the Water Board as having inherent water quality and other environmental benefits.

Projects that receive LID treatment reduction credits may be allowed to use specific types of non-LID treatment, if the use of LID treatment is first evaluated and determined to be infeasible by the permitting jurisdiction. ***Prior to the municipal agency granting the use of any LID Treatment Reduction Credits, the applicant must demonstrate that treating 100% of the amount of runoff specified in Provision C.3.d with LID is infeasible.*** Section J.6 describes the documentation that must be provided by the project applicant to show why the use of LID treatment is infeasible and LID treatment reduction credits will be used

The types of non-LID treatment that may be used are:

- High flow-rate media filters, and
- High flow-rate tree well filters (also called high flow-rate tree box filters).

The three categories of Special Projects are:

- Category A: Small Infill Projects ( $\leq \frac{1}{2}$  acre of impervious surface)
- Category B: Larger Infill Projects ( $\leq 2$  acres of impervious surface)
- Category C: Affordable Housing Projects

Any Regulated Project that meets all the criteria for more than one Special Project Category (such as a Regulated Project that may be characterized as a Category B or C Special Project) may only use the LID Treatment Reduction Credit allowed under one of the categories. For example, a Regulated Project that may be characterized as a Category B or C Special Project may use the LID Treatment Reduction Credit allowed under Category B or Category C, but not the sum of both.

### J.1 Category A: Small Infill Projects

The defining criteria and LID treatment reduction credits for Category A projects are described below.

### Criteria for Category A (Small Infill) Special Projects

To be considered a Category A Special Project, a Provision C.3 Regulated Project must meet all of the following criteria:

1. Be built as part of the municipality's stated objective to preserve or enhance a pedestrian-oriented type of urban design.
2. Be located in the municipality's designated central business district, downtown core area or downtown core zoning district, neighborhood business district or comparable pedestrian oriented commercial district, or historic preservation site and/or district.
3. Create and/or replace one half acre or less of impervious surface area.
4. Include no surface parking, except for incidental surface parking. Incidental surface parking is allowed only for emergency vehicle access, Americans with Disabilities Act (ADA) accessibility, and passenger and freight loading zones.
5. Have at least 85% coverage for the entire project site by permanent structures. The remaining 15% portion of the site is to be used for safety access, parking structure entrances, trash and recycling service, utility access, pedestrian connections, public uses, landscaping, and stormwater treatment.

### LID Treatment Reduction for Category A (Small Infill) Special Projects

A Category A Special Project may qualify for 100% LID Treatment Reduction Credit, which would allow the Category A Special Project to treat up to 100% of the amount of stormwater runoff specified by Provision C.3.d with either one or a combination of the two types of allowed non-LID treatment systems (high flow-rate media filters and high flow-rate tree well filters). Prior to receiving the LID treatment reduction credits, the applicant must demonstrate, to the satisfaction of municipal staff, that LID treatment is infeasible, as described in Section J.6.

## *J.2 Category B: Larger Infill Projects*

The defining criteria and LID treatment reduction credits for Category B projects are described below.

### Criteria for Category B (Larger Infill) Special Projects

To be considered a Category B Special Project, a Provision C.3 Regulated Project must meet all of the following criteria:

1. Be built as part of the municipality's stated objective to preserve or enhance a pedestrian-oriented type of urban design.
2. Be located in a municipality's designated central business district, downtown core area or downtown core zoning district, neighborhood business district or comparable pedestrian oriented commercial district, or historic preservation site and/or district.
3. Create and/or replace greater than one-half acre but no more than 2 acres of impervious surface area.

4. Include no surface parking, except for incidental surface parking. Incidental surface parking is allowed only for emergency vehicle access, ADA accessibility, and passenger and freight loading zones.
5. Have at least 85% coverage for the entire project site by permanent structures. The remaining 15% portion of the site is to be used for safety access, parking structure entrances, trash and recycling service, utility access, pedestrian connections, public uses, landscaping, and stormwater treatment.

### LID Treatment Reduction for Category B (Larger Infill) Special Projects

For Category B Special Projects, the maximum LID treatment reduction credit allowed varies depending upon the density achieved by the project in accordance with the criteria shown in Table J-1. Density is expressed in Floor Area Ratios (FARs)<sup>59</sup> for commercial projects and in Dwelling Units per Acre (DU/Ac)<sup>60</sup> (gross density) for residential development projects. Density of mixed-use development projects may be expressed as FAR or DU/Ac. The credits are expressed in percentages of the amount of stormwater runoff specified by Provision C.3.d for the Project’s drainage area. The Special Project may treat the percentage of the C.3.d amount of runoff that corresponds to the project’s density using either one or a combination of the two types of allowed non-LID treatment systems (high flow-rate media filters and high flow-rate tree well filters). To be eligible to receive the LID treatment reduction credits, the applicant must demonstrate, to the satisfaction of municipal staff, that LID treatment is infeasible, as described in Section J.6. Any remaining amount of stormwater runoff must be treated with LID treatment measures.

<b>% of the C.3.d Amount of Runoff that May Receive Non-LID Treatment</b>	<b>Land Use Type</b>	<b>Density Required to Obtain the LID Treatment Reduction Credit<sup>59, 60</sup></b>
50%	Commercial	Floor Area Ratio 2:1
50%	Residential	50 Dwelling Units/Acre
50%	Mixed Use	Floor Area Ratio 2:1, or 50 Dwelling Units/Acre
75%	Commercial	Floor Area Ratio 3:1
75%	Residential	75 Dwelling Units/Acre
75%	Mixed Use	Floor Area Ratio 3:1, or 75 Dwelling Units/Acre
100%	Commercial	Floor Area Ratio 4:1
100%	Residential	100 Dwelling Units/Acre
100%	Mixed Use	Floor Area Ratio 4:1, or 100 Dwelling Units/Acre

<sup>59</sup> Floor Area Ratio = The ratio of the total floor area on all floors of all buildings at a project site (except structures, floors, or floor areas dedicated to parking) to the total project site area.

<sup>60</sup> Gross Density in Dwelling Units per Acre = The total number of residential units divided by the acreage of the entire site area, including land occupied by public rights-of-way, recreational, civic, commercial and other non-residential uses

### J.3 Category C: Affordable Housing Projects

The defining criteria and LID treatment reduction credits for Category C projects are described below. These criteria are effective November 1, 2023.

#### Criteria for Category C (Affordable Housing) Special Projects

To be considered a Category C Special Project, a Provision C.3 Regulated Project must meet all of the following criteria:

1. Be a preserved housing project with deed restriction running at least 55 years, at rent/mortgage rates (including utilities) no greater than 30 percent of the area median household income (AMI) limits adjusted for household size based on the maximum percentage of AMI for each income category, which are defined by the Federal Department of Housing and Urban Development (HUD) for affordable housing in metropolitan areas<sup>61</sup>.
2. Primarily be a residential project (i.e., at least two-thirds of the square footage of the project should be designated for residential use).
3. Meet the minimum gross density of 40 dwelling units per acre.

#### Exemption for Emergency Homeless Shelters

Emergency homeless shelters constructed pursuant to and consistent with Government Code § 8698.4, including the definition of “homeless shelter” in subdivision (c), and that are temporary<sup>62</sup> are not Regulated Projects under Provision C.3.b. As such, they are not subject to Provisions C.3.c (LID) and C.3.d (Numeric Sizing Criteria for Stormwater Treatment Systems) and shall instead comply with Provision C.3.i (Site Design Measures for Small Projects) and implement relevant BMPs developed under Provision C.17 (Discharges Associated with Unsheltered Homeless Populations). If the homeless shelter become permanent and the impervious surfaces it created and/or replaced meet the thresholds for a Regulated Project, or if there is a new Regulated Project and/or Special Project at the site, the project shall comply with Provision C.3, including Provisions C.3.c and C.3.d.

#### LID Treatment Reduction for Category C (Affordable Housing)

For Category C Special Projects, the total maximum LID treatment reduction credit allowed is the sum of four different types of credits for which the Category C Special Project qualifies. These credits are categorized as follows:

- Affordable Housing Credits,
- Location Credits,
- Density Credits, and
- Minimized Surface Parking Credits.

---

<sup>61</sup> For metropolitan areas, HUD defines Acutely Low household incomes as 0-15 percent of AMI, Extremely Low household incomes as 16-30 percent of AMI, Very Low household incomes as 31-50 percent of AMI, Low household incomes as 51-80 percent of AMI, and Moderate household incomes as 81-120 percent of AMI.

<sup>62</sup> Examples of temporary emergency housing projects are: formal “community cabin” or tent communities; RV safe parking areas; and homeless “navigation centers” with housing, that are temporary and provide housing for people experiencing unsheltered homelessness.



The credits represent the percentages of the amount of stormwater runoff specified by Provision C.3.d for the project’s drainage area that may be allowed to use non-LID treatment. Note that to qualify for Location, Density, or Minimized Surface Parking credits, a project must first meet all of the Affordable Housing Criteria described above. The total maximum LID Treatment Reduction Credit for any Category C Special Project may not exceed 100 percent.

The Special Project may use either one or a combination of the two types of allowed non-LID treatment systems (high flow-rate media filters and high flow-rate tree well filters) to treat up to the total percentage of the C.3.d amount of stormwater runoff that results from adding together the Affordable Housing, Location, Density and Minimized Surface Parking credits for which the project is eligible. In addition, to be eligible to receive the LID treatment reduction credits, the applicant must demonstrate, to the satisfaction of municipal staff, that LID treatment is infeasible, as described in Section J.6. Any remaining amount of stormwater runoff must be treated with LID treatment measures. The approach to calculating each type of credit allowed under Category C Affordable Housing is described below.

### Affordable Housing Credits (Affordable Housing)

Affordable Housing projects can receive 0% to 100% LID treatment reduction credits based on the percentage of dwelling units in the following **Area Median Household Income (AMI)** categories: moderate income, low income, very low income, extremely low income and acutely low income. The income limits used for these criteria should be the most current Official State Income Limits (adjusted for household size, and specific to each county), which are defined on the California HUD website<sup>6364</sup>.

Up to three DUs that are used as building managers’ DUs may be exempted from the deed restriction requirement and may be excluded from the calculations described below and in Provision C.3.e.ii.(5)(c)(i)-(ii). The steps for calculating the credits are described below:

**Step 1 - Weighted Sum Calculation:** Calculate the percentage of the project’s DUs in each AMI category. Multiply the percentage of the project’s DUs in each AMI category by the respective credit multiplier, according to Table J-2 below. Add the available credits for each affordable category to produce the Weighted Sum, and round to the nearest whole number.

*Table J-2: Step 1 – Weighted Sum Calculation*

AMI	Number of DUs	Percentage of DUs <sup>65</sup>	Credit Multiplier	Available Credit
Moderate (≤120% of AMI)			0.20	
Low (≤ 80% of AMI)			1.00	
Very Low (≤ 50% of AMI)			2.00	
Extremely Low (≤30% of AMI)			3.00	
Acutely Low (≤15% of AMI) <sup>66</sup>			4.00	
<b>Weighted Sum (rounded)</b>				

**Step 2 - Allowable Affordable Housing Credit:** Use Table J-3 to identify the correct Weighted Sum Category for the Weighted Sum calculated in Step 1. This is the Allowable Affordable Housing Credit. For example, if the Weighted Sum is 45 percent, that would fall into the 41-50 percent Weighted Sum Category, and

<sup>63</sup> <https://www.hcd.ca.gov/grants-and-funding/income-limits/state-and-federal-income-rent-and-loan-value-limits>

<sup>64</sup> As of June 6, 2023, they are: <https://www.hcd.ca.gov/sites/default/files/docs/grants-and-funding/income-limits-2023.pdf>

<sup>65</sup> Up to three DUs that are used as building managers’ DUs may be exempted from percentage calculations.

<sup>66</sup> DUs that are free to tenants, i.e., that do not charge tenants any rent/mortgage, are included in this category.

therefore the maximum Allowable Affordable Housing Credit available to the project would be 50 percent. The location, density, and surface parking credits will be added to this Allowable Affordable Housing Credit.

*Table J-3: Step 2 – Allowable Affordable Housing Credit*

Weighted Sum (X) Category	Allowable Affordable Housing Credit
$X \leq 9\%$	0%
$10\% \leq X \leq 20\%$	20%
$21\% \leq X \leq 30\%$	30%
$31\% \leq X \leq 40\%$	40%
$41\% \leq X \leq 50\%$	50%
$51\% \leq X \leq 60\%$	60%
$61\% \leq X \leq 70\%$	70%
$71\% \leq X \leq 80\%$	80%
$81\% \leq X \leq 90\%$	90%
$91\% \leq X$	100%

### Location Credits (Affordable Housing)

Location Credits are based on the project site’s proximity to a transit hub<sup>67</sup>, or its location within a planned Priority Development Area (PDA)<sup>68</sup>. The method for calculating is presented in Table J-4. To qualify for any Location Credits, a Category C Special Project must first qualify for all of the Affordable Housing Criteria listed above. Only one Location Credit may be used by an individual Category C Special Project, even if the project qualifies for multiple Location Credits. In order to qualify for a Location Credit, 100% of a Category C Special Project’s site must be located within a ¼ mile radius of an existing or planned transit hub, or 100% of the site must be located within a PDA.

*Table J-4: Location Credits for Category C, Affordable Housing*  
(Only one Location Credit may be used.)

% of the C.3.d Amount of Runoff that May Receive Non-LID Treatment	Project Site Location
5%	Entire project is located within the ¼ mile radius of an existing or planned transit hub
10%	100% of the site is located within a PDA

<sup>67</sup> Transit hub is defined as a rail, light rail, or commuter rail station, ferry terminal, or bus transfer station served by three or more bus routes (i.e., a bus stop with no supporting services does not qualify). A planned transit hub is a station on the MTC’s Regional Transit Expansion Program list, per MTC’s Resolution 3434 (revised April 2006), which is a regional priority funding plan for future transit stations in the San Francisco Bay Area.

<sup>68</sup> A planned Priority Development Area (PDA) is an infill development area formally designated by the Association of Bay Area Government’s / Metropolitan Transportation Commission’s FOCUS regional planning program. FOCUS is a regional incentive-based development and conservation strategy for the SF Bay Area.

To determine the distance from the transit hub, draw a circle around the transit hub with its center in the center of the transit hub and its radius equal to ¼ mile. If 100% of the project site falls within the circle, the associated credits may be applied. The distance is measured “as the crow flies” and may not be the actual walking distance to the transit hub.

### Density Credits (Affordable Housing)

To qualify for any Density Credits, a Category C Special Project must first qualify for all of the Affordable Housing Criteria listed above. The Density Credits are based on the density achieved by the project in accordance with the criteria shown in Table J-5. Density is expressed in Dwelling Units per Acre (DU/Ac) for residential projects as well as for mixed-use development projects. (Since these projects are supposed to be primarily residential, the MRP does not allow Category C Projects to use FAR.) Only one Density Credit may be used by an individual Category C Special Project, even if the project qualifies for multiple Density Credits.

<i>Table J-5: Density Credits for Category C, Affordable Housing</i> (Only one Location Credit may be used.)	
<b>% of the C.3.d Amount of Runoff that May Receive Non-LID Treatment</b>	<b>Density Required to Obtain the Density Credit</b>
5%	≥ 40 Dwelling Units/Acre
10%	≥ 60 Dwelling Units/Acre
15%	≥ 100 Dwelling Units/Acre

**Notes:**

Dwelling Units per Acre (Gross Density) = The total number of residential units divided by the acreage of the entire site area, including land occupied by public rights-of-way, recreational, civic, commercial and other non-residential uses.

### Minimized Surface Parking Credits (Affordable Housing)

To qualify for the Minimized Surface Parking Credits, a Category C Special Project must first qualify for all of the Affordable Housing Criteria listed above. The requirement to achieve the Minimized Surface Parking Credit is shown below in Table J-6.

<i>Table J-6: Minimized Surface Parking Credits for Category C, Affordable Housing</i> (Only one Minimized Surface Parking Credit may be used.)	
<b>% of the C.3.d Amount of Runoff that May Receive Non-LID Treatment</b>	<b>Percentage of the Total Post-Project Impervious Surface Dedicated to At-Grade, Surface Parking</b>
5%	0% (except for emergency vehicle access, ADA accessibility and passenger and freight loading zones)

## *J.4 Calculating the LID Treatment Reduction Credit (Special Projects Worksheet)*

The Countywide Program has prepared a Special Projects Worksheet (Attachment J-1) to document that a project meets the criteria for Special Project Categories A, B, and/or C and to calculate the total allowable LID treatment reduction credit for which the project is eligible. The municipality may require submittal of the Special Projects Worksheet, or a similar worksheet, as part of project submittals. To download an electronic version of the worksheet, visit the Program's website [www.flowstobay.org](http://www.flowstobay.org) and click on "At Work", then "New Development", then "Forms and Checklists".

If the project meets all the criteria for more than one Special Project Category, it may use only the LID treatment reduction credit allowed under one of the categories. However, the worksheet may be used to compute the credit allowed under each category in order to determine which category would allow the most credit.

## *J.5 Applying the LID Treatment Reduction Credits to Special Projects*

The following steps should be used to develop a project-specific stormwater management plan for a Special Project and apply the LID treatment reduction credits allowed for the project.

1. Determine the total amount of impervious surface created and/or replaced on site that is subject to C.3 treatment requirements, and the associated C.3.d volume of runoff. This is the area and volume for which the LID treatment reduction credits will be applied to determine the maximum amount of runoff that can be treated using non-LID treatment measures.
2. Define drainage management areas on the site, and identify self-treating and self-retaining areas, if any (see Chapter 4).
3. Adjust drainage management areas as needed to route the amount of runoff that needs to be treated with LID treatment measures and as much of the rest of the C.3.d amount of runoff as possible to LID treatment measures.
4. For the portion of runoff that must be treated with non-LID treatment measures (up to the allowable LID treatment reduction credit), document the reasons why LID treatment measures cannot be used (see Section J.6).

## *J.6 LID Infeasibility Requirement for Special Projects*

In order to be considered a Special Project, in addition to documenting that all applicable criteria for one of the above-described Special Project categories have been met, the project applicant must provide a narrative discussion of the feasibility or infeasibility of using 100% LID treatment onsite and offsite, for review by municipal staff. Both technical and economic feasibility or infeasibility should be discussed, as applicable. The narrative discussion should establish all of the following:

- The infeasibility of treating 100% of the amount of runoff identified in Provision C.3.d for the Regulated Project's drainage area with LID treatment measures onsite.
- The infeasibility of treating 100% of the amount of runoff identified in Provision C.3.d for the Regulated Project's drainage area with LID treatment measures offsite or paying in-lieu fees to treat 100% of the Provision C.3.d runoff with LID treatment measures at an offsite or Regional Project.
- The infeasibility of treating 100% of the amount of runoff identified in Provision C.3.d for the Regulated Project's drainage area with some combination of LID treatment measures onsite, offsite, and/or paying in-lieu fees toward an offsite or Regional Project.

The narrative discussion should describe how the routing of stormwater runoff has been optimized to route as much runoff as possible to LID treatment measures. The discussion should also describe the technical constraints that preclude the use of any onsite landscaped areas for LID.

In addition, the applicant must demonstrate to the municipality performing the project review that it is infeasible to provide LID treatment of an equivalent amount of runoff offsite either at a regional project or on other property in the same watershed (i.e., demonstrate that alternative compliance, as described in Chapter 9, is infeasible). Check with the local municipality to determine if there are any regional projects or other options available for alternative compliance purposes.

Attachment J-1, on the following page, provides the Special Projects form and Attachment J-2 includes a template for preparing a narrative discussion on the feasibility or infeasibility of providing 100 percent LID treatment.

Please note that your municipality may require a higher proportion of LID treatment than allowed in this section, at its discretion, based on site context and constraints.

Project Name:  
Project Address:  
Applicant/Developer Name:

### 1. “Special Project” Determination:

#### Special Project Category “A”

Does the project have ALL of the following characteristics?

- Located in a municipality’s designated central business district, downtown core area or downtown core zoning district, neighborhood business district or comparable pedestrian-oriented commercial district, or historic preservation site and/or district<sup>1</sup>;
  - Creates and/or replaces 0.5 acres or less of impervious surface;
  - Includes no surface parking, except for incidental parking for emergency vehicle access, ADA access, and passenger or freight loading zones;
  - Has at least 85% coverage of the entire site by permanent structures. The remaining 15% portion of the site may be used for safety access, parking structure entrances, trash and recycling service, utility access, pedestrian connections, public uses, landscaping and stormwater treatment.
- No (continue)       Yes – complete Section 2 of the Special Project Worksheet

#### Special Project Category “B”

Does the project have ALL of the following characteristics?

- Located in a municipality’s designated central business district, downtown core area or downtown core zoning district, neighborhood business district or comparable pedestrian-oriented commercial district, or historic preservation site and/or district<sup>1</sup>;
  - Creates and/or replaces an area of impervious surface that is greater than 0.5 acres, and no more than 2.0 acres;
  - Includes no surface parking, except for incidental parking for emergency access, ADA access, and passenger or freight loading zones;
  - Has at least 85% coverage of the entire site by permanent structures. The remaining 15% portion of the site may be used for safety access, parking structure entrances, trash and recycling service, utility access, pedestrian connections, public uses, landscaping and stormwater treatment;
  - Minimum Gross<sup>2</sup> density of either 50 dwelling units per acre (for residential or mixed use projects) or a Floor Area Ratio<sup>3</sup> (FAR) of 2:1 (for commercial or mixed use projects)
- No (continue)       Yes – complete Section 2 of the Special Project Worksheet

#### Special Project Category “C”

Does the project have ALL of the following characteristics?

- Is a preserved housing project with a deed restriction running at least 55 years, at rent/mortgage  $\leq$ 30% of the maximum Area Median Household Income (AMI) limits adjusted for household size based on the maximum percentage of AMI for each income category, according to the Federal Department of Housing and Urban Development’s (HUD’s) definition of affordable housing in metropolitan areas.<sup>4</sup>
  - Primarily a residential project, i.e., at least two-thirds of the square footage of the project is designated for residential use.<sup>5</sup>
  - Minimum Gross<sup>2</sup> density of 40 Dwelling Units (DUs) per acre.
- No                       Yes – Calculate the Allowable Available Housing Credit using the steps below. Then complete Section 2 of the Special Project Worksheet.

<sup>1</sup> And built as part of a municipality’s stated objective to preserve/enhance a pedestrian-oriented type of urban design.

<sup>2</sup> Gross density is defined as the total number of residential units divided by the acreage of the entire site area, including land occupied by public rights-of-way, recreational, civic, commercial, and other non-residential uses.

<sup>3</sup> Floor Area Ratio is defined as the ratio of the total floor area on all floors of all buildings at a project site (except structures, floors, or floor areas dedicated to parking) to the total project site area.

<sup>4</sup> For metropolitan areas, HUD defines Acutely Low household incomes as 0-15% of AMI, Extremely Low household incomes as 16-30% of AMI, Very Low household incomes as 31-50% of AMI, Low household incomes as 51-80% of AMI, and Moderate household incomes as 81-120% of AMI.

<sup>5</sup> Emergency homeless shelters constructed pursuant to and consistent with Government Code § 8698.4, including the definition of “homeless shelter” in subdivision (c), and that are temporary, are exempt from stormwater treatment requirements, and are required to implement site design measures (MRP Provision C.3.i) and relevant BMPs for unsheltered populations (Provision C.17).

# Special Projects Worksheet

**Step 1 - Weighted Sum Calculation:** Calculate the percentage of the project's DUs in each AMI category. Multiply the percentage of the project's DUs in each AMI category by the respective credit multiplier, per Table 1a below. Add the available credits for each affordable category to produce a weighted sum, and round to the nearest whole number.

- a. Total number of DUs: \_\_\_\_\_
- b. Total number of Managers' Units<sup>6</sup>: \_\_\_\_\_
- c. Total number of DUs for Affordable Credit Calculation (a - b): \_\_\_\_\_ (Use this number for calculating percentages in Table 1a)

Table 1a – Weighted Sum Calculation				
AMI	Number of DUs	Percentage of DUs	Credit Multiplier	Available Credit (% of DUs * Credit Multiplier)
Moderate (≤120% of AMI)			0.20	
Low (≤ 80% of AMI)			1.00	
Very Low (≤ 50% of AMI)			2.00	
Extremely Low (≤30% of AMI)			3.00	
Acutely Low (≤15% of AMI) <sup>7</sup>			4.00	
<b>WEIGHTED SUM (Rounded)</b>				

**Step 2 - Allowable Affordable Housing Credits:** Use Table 1b to identify the correct Weighted Sum Category for the Weighted Sum calculated in Step 1. This is the Allowable Affordable Housing Credit. For example, if the Weighted Sum is 45%, that would fall into the 41-50% Weighted Sum Category, and the maximum Allowable Affordable Housing Credit available to the project would be 50%.

Table 1b – Allowable Affordable Housing Credit Calculation		
Weighted Sum (X) Category	Allowable Affordable Housing Credit	Applicable Weighted Sum Category (Select One)
X ≤ 9%	0%	<input type="checkbox"/>
10% ≤ X ≤ 20%	20%	<input type="checkbox"/>
21% ≤ X ≤ 30%	30%	<input type="checkbox"/>
31% ≤ X ≤ 40%	40%	<input type="checkbox"/>
41% ≤ X ≤ 50%	50%	<input type="checkbox"/>
51% ≤ X ≤ 60%	60%	<input type="checkbox"/>
61% ≤ X ≤ 70%	70%	<input type="checkbox"/>
71% ≤ X ≤ 80%	80%	<input type="checkbox"/>
81% ≤ X ≤ 90%	90%	<input type="checkbox"/>
91% ≤ X	100%	<input type="checkbox"/>

<sup>6</sup> Up to three DUs that are used as building managers' DUs may be excluded from the percentage calculations.

<sup>7</sup> DUs that are free to tenants, i.e., that do not charge tenants any rent/mortgage, are included in this category.

## Special Projects Worksheet

### 2. LID Treatment Reduction Credit Calculation:

Category	Impervious Area Created/ Replaced (acres)	Site Coverage (%)	Project Density or FAR	Density/Criteria	Allowable Credit (%)	Applied Credit (%)
A			N.A.	N.A.	100%	
B				Res ≥ 50 DU/ac or FAR ≥ 2:1	50%	
				Res ≥ 75 DU/ac or FAR ≥ 3:1	75%	
				Res ≥ 100 DU/ac or FAR ≥ 4:1	100%	
C		N.A.		<b>Allowable Affordable Housing Credit from Step 2 above</b>	0%-100%	
				<b>Location credit (select one):</b>		
				Entire project is located within ¼ mile of transit hub <sup>8</sup>	5%	
				Entire project is located within a planned PDA <sup>9</sup>	10%	
				<b>Density credit (select one):</b>		
				Res ≥ 40 DU/ac	5%	
				Res ≥ 60 DU/ac	10%	
				Res ≥ 100 DU/ac	15%	
				<b>Parking credit (select one):</b>		
				No surface parking	5%	
				<b>TOTAL CREDIT =</b>		

SMCWPPP gratefully acknowledges the Santa Clara Valley Urban Runoff Pollution Prevention Program (SCVURPPP) for the use of this checklist.

<sup>8</sup> "Transit hub" is defined as a rail, light rail, or commuter rail station, ferry terminal, or bus transfer station served by three or more bus routes. (A bus stop with no supporting services does not qualify.)

<sup>9</sup> A "planned Priority Development Area" is an infill development area formally designated by the Association of Bay Area Government's / Metropolitan Transportation Commission's FOCUS regional planning program.



## Attachment J-2: Template for Narrative Discussion of LID Feasibility or Infeasibility

For each potential Special Project, provide a narrative discussion of the feasibility or infeasibility of 100% LID treatment, onsite and offsite, using the template provided below. Insert information specific to the project where indicated with brackets and yellow shading `[[= insert information here =]]`. Delete this text box before completing the narrative discussion.

### `[[= Insert Project Name =]]` Narrative Discussion of Low Impact Development Feasibility/Infeasibility

This report provides a narrative discussion of the feasibility or infeasibility of providing 100 percent low impact development (LID) treatment for `[[= Insert Project Name =]]`, which has been identified as a potential Special Project, based on Special Project criteria provided in Provision C.3.e.ii of the Municipal Regional Stormwater Permit (MRP). This report is prepared in accordance with the requirement in MRP Provision C.3.e.vi.(2), to include in Special Projects reporting a narrative discussion of the feasibility or infeasibility of 100 percent LID treatment onsite or offsite.

#### 1. Feasibility/Infeasibility of Onsite LID Treatment

The project site was reviewed with regard to the feasibility and infeasibility of onsite LID treatment. The results of this review showed that it was `[[= feasible/infeasible =]]` to treat `[[= ___ percent [fill in percentage] =]]` of the C.3.d amount of runoff with LID treatment. The findings of this review are presented below.

- a. **On-site Drainage Conditions.** `[[= Describe the site drainage, including the site slope, direction of flow, and how the site was divided into drainage management areas that will each drain to a separate stormwater treatment measure. =]]`
- b. **Self-treating and Self-Retaining Areas and LID Treatment Measures.** `[[= Describe any drainage management areas for which self-treating or self-retaining areas (such as pervious pavement, green roofs or landscaped areas) or LID treatment measures are provided. If there are none, delete this paragraph. =]]`.
- c. **Maximizing Flow to LID Features and Facilities.** `[[= Explain how the routing of drainage has been optimized to route as much drainage as possible to LID features and facilities (if any). If there are no LID features or facilities, delete this paragraph. =]]`
- d. **Constraints to Providing On-site LID.** The drainage management areas that are proposed to drain to tree-box type high flow rate biofilters and/or vault-based high flow rate media filters include some areas that are not covered by buildings. `[[= Briefly describe all areas within these portions of the site that are not covered by buildings. =]]` In these areas, conditions and technical constraints are present that preclude the use of LID features and facilities, as described below.
  - i. Impervious paved areas: `[[= Describe the uses of all impervious paved areas in these areas, and why the uses preclude the use of LID treatment. =]]`
  - ii. Landscaped areas: `[[= For any of the following bullet points that are applicable, briefly describe how the conditions apply to the applicable landscaped areas. Delete any of the bullet points that are not applicable. =]]`
    - Inadequate size to accommodate biotreatment facilities that meet sizing requirements for the tributary area.
    - Slopes too steep to terrace;
    - Proximity to an unstable bank or slope;
    - Environmental constraints (for example, landscaped area is within riparian corridor);
    - High groundwater or shallow bedrock;

- Conflict with subsurface utilities;
- Cap over polluted soil or groundwater;
- Lack of head or routing path to move collected runoff to the landscaped area or from the landscaped area to a disposal point;
- Other conflicts, including required uses that preclude use for stormwater treatment (describe in more detail).

2. **Feasibility/Infeasibility of Off-Site LID Treatment.** The possibility of providing off-site LID treatment was found to be **[[=feasible/infeasible =]]** for the following reasons.

- [[= Describe whether the project proponent owns or otherwise controls land within the same watershed of the project that can accommodate in perpetuity off-site bioretention facilities adequately sized to treat the runoff volume of the primary project. =]]**
- [[= Indicate whether there is a regional LID stormwater mitigation program available to the project for in-lieu C.3 compliance. =]]**

# Appendix K: Biotreatment Soil Media Specifications

<i>Introduction</i> .....	K-2
<i>K.1 BASMAA Regional Biotreatment Soil Specification</i> .....	K-3

## Introduction

The MRP requires Regulated Projects to use biotreatment soil media that meet the minimum specifications set forth in Attachment L of the previous permit (Order No. R2-2009-0074). The MRP also allows Permittees to collectively develop and adopt revisions to the soil media minimum specifications subject to the Water Board Executive Officer's approval. On February 5, 2016, Permittees submitted revisions to the soil specifications to address issues with the current soil media specifications that Permittees have identified, based on implementation of these soil media specifications for the last 5 years under the previous MRP. The Water Board Executive Officer approved the revised soil specifications on April 18, 2016. This appendix contains the revised biotreatment soil mix (BSM) specifications that is now known as the BASMAA BSM specification posted on the BASMAA website at <http://basmaa.org/Announcements/basmaa-revisions-to-mrp-biotreatment-soil-mix-bsm-spec>. All Regulated Projects are required to use this revised BASMAA BSM specification.

To assist permittees and others in complying with this requirement, the program has produced several documents including a guidance memorandum and a Biotreatment Soil Media Supplier List. To see the documents, please visit the SMCWPPP website at: [www.flowstobay.org/newdevelopment](http://www.flowstobay.org/newdevelopment) and look under the section "**Forms and Checklists.**"

Municipal agencies have different needs and may want to design their review processes accordingly. Some agencies may want go through a detailed process with the BSM checklist every time or only with their own agency projects. Others may want to do that only with first-time contractors or for a few projects until everyone is familiar with the process.

In 2014, the Program vetted several BSM suppliers and created a vendor list. The list is amended as needed when other suppliers submit verification information. The Program provides this list of BSM suppliers for the use of its member agencies, contractors, designers and others in finding suppliers for their projects. Suppliers are listed based on a general review of their soil media product including test results, adherence to the BSM specification in the MRP and knowledge of the specification. Users of the vendor list must make the final determination as to the products and adherence to the MRP. The listing of any soil supplier is not to be construed as an actual or implied endorsement, recommendation, or warranty of such soil supplier or their products, nor is criticism implied of similar soil suppliers that are not listed. The newest version of the BSM Supplier list is posted on the program website.

The BSM checklist, provided as Attachment K-1, is intended to supply municipal staff, contractors, designers and others with an easy-to-read summary of the detailed information needed to verify that the BSM being provided by the BSM supplier meets the BSM specification.

## K.1 BASMAA Regional Biotreatment Soil Media Specification

Soils for biotreatment or bioretention areas shall meet two objectives:

- Be sufficiently permeable to infiltrate runoff at a minimum rate of 5" per hour during the life of the facility, and
- Have sufficient moisture retention to support healthy vegetation.

Achieving both objectives with an engineered soil media requires careful specification of soil gradations and a substantial component of organic material (typically compost).

Local soil product suppliers have expressed interest in developing 'brand-name' media that meet these specifications. At their sole discretion, municipal construction inspectors may choose to accept test results and certification for a 'brand-name' media from a soil supplier.

- Tests must be conducted within 120 days prior to the delivery date of the bioretention soil to the project site.
- Batch-specific test results and certification shall be required for projects installing more than 100 cubic yards of bioretention soil.

### Soil Specifications

Bioretention soils shall meet the following criteria. "Applicant" refers to the entity proposing the soil mixture for approval by a Permittee.

1. General Requirements – Bioretention soil shall:

- a. Achieve a long-term, in-place infiltration rate of at least 5 inches per hour.
- b. Support vigorous plant growth.
- c. Consist of the following mixture of fine sand and compost, measured on a volume basis:

60%-70% Sand

30%-40% Compost

2. Submittal Requirements – The applicant shall submit to the Permittee for approval:

- a. A minimum one-gallon size sample of mixed bioretention soil.
- b. Certification from the soil supplier or an accredited laboratory that the Bioretention Soil meets the requirements of this guideline specification.
- c. Grain size analysis results of the fine sand component performed in accordance with ASTM D 422, Standard Test Method for Particle Size Analysis of Soils or Caltrans Test Method (CTM) C202.
- d. Quality analysis results for compost performed in accordance with Seal of Testing Assurance (STA) standards, as specified in 4.
- e. Organic content test results of mixed Bioretention Soil. Organic content test shall be performed in accordance with by Testing Methods for the Examination of Compost and Composting (TMECC) 05.07A, "Loss-On-Ignition Organic Matter Method".

- f. Grain size analysis results of compost component performed in accordance with ASTM D 422, Standard Test Method for Particle Size Analysis of Soils.
- g. A description of the equipment and methods used to mix the sand and compost to produce Bioretention Soil.
- h. Provide the name of the testing laboratory(s) and the following information:
  - (1) Contact person(s)
  - (2) Address(s)
  - (3) Phone contact(s)
  - (4) E-mail address(s)
  - (5) Qualifications of laboratory(s), and personnel including date of current certification by USCC, ASTM, Caltrans, or approved equal

3. Sand for Bioretention Soil

- a. Sand shall be free of wood, waste, coating such as clay, stone dust, carbonate, etc., or any other deleterious material. All aggregate passing the No. 200 sieve size shall be nonplastic.
- b. Sand for Bioretention Soils shall be analyzed by an accredited lab using #200, #100, #40 or #50, #30, #16, #8, #4, and 3/8 inch sieves (ASTM D 422, CTM 202 or as approved by municipality), and meet the following gradation:

Sieve Size	Percent Passing (by weight)	
	<i>Min</i>	<i>Max</i>
3/8 inch	100	100
No. 4	90	100
No. 8	70	100
No. 16	40	95
No. 30	15	70
No. 40 or No.50	5	55
No. 100	0	15
No. 200	0	5

**Note:** all sands complying with ASTM C33 for fine aggregate comply with the above gradation requirements.

4. Composted Material

Compost shall be a well decomposed, stable, weed free organic matter source derived from waste materials including yard debris, wood wastes or other organic materials not including manure or biosolids meeting the standards developed by the US Composting Council (USCC). The product shall be certified through the USCC Seal of Testing Assurance (STA) Program (a compost testing and information disclosure program).

- a. Compost Quality Analysis by Laboratory – Before delivery of the soil, the supplier shall submit a copy of lab analysis performed by a laboratory that is enrolled in the US Composting Council’s Compost Analysis Proficiency (CAP) program and using approved Test Methods for the Examination of Composting and Compost (TMECC). The lab report shall verify:
- (1) Organic Matter Content: 35% - 75% by dry wt.
  - (2) Carbon and Nitrogen Ratio: C:N < 25:1 and C:N >15:1
  - (3) Maturity/Stability: Any one of the following is required to indicate stability:
    - (i) Oxygen Test < 1.3 O<sub>2</sub> /unit TS /hr
    - (ii) Specific oxy. Test < 1.5 O<sub>2</sub> / unit BVS /hr
    - (iii) Respiration test < 8 mg CO<sub>2</sub>-C /g OM / day
    - (iv) Dewar test < 20 Temp. rise (°C) e.
    - (v) Solvita® > 5 Index value
  - (4) Toxicity: Any one of the following measures is sufficient to indicate non-toxicity.
    - (i) NH<sub>4</sub><sup>+</sup> : NO<sub>3</sub><sup>-</sup>-N < 3
    - (ii) Ammonium < 500 ppm, dry basis
    - (iii) Seed Germination > 80 % of control
    - (iv) Plant Trials > 80% of control
    - (v) Solvita® = 5 Index value
  - (5) Nutrient Content: provide analysis detailing nutrient content including N-P-K, Ca, Na, Mg, S, and B.
    - (i) Total Nitrogen content 0.9% or above preferred.
    - (ii) Boron: Total shall be <80 ppm;
  - (6) Salinity: Must be reported; < 6.0 mmhos/cm
  - (7) pH shall be between 6.2 and 8.2 May vary with plant species.
- b. Compost Quality Analysis by Compost Supplier – Before delivery of the compost to the soil supplier the Compost Supplier shall verify the following:
- (1) Feedstock materials shall be specified and include one or more of the following: landscaping/yard trimmings, grass clippings, food scraps, and agricultural crop residues.
  - (2) Maturity/Stability: shall have a dark brown color and a soil-like odor. Compost exhibiting a sour or putrid smell or containing recognizable grass or leaves, or is hot (120F) upon delivery or rewetting is not acceptable.
  - (3) Weed seed/pathogen destruction: provide proof of process to further reduce pathogens (PFRP). For example, turned windrows must reach min. 55C for 15 days with at least 5 turnings during that period.

- c. Compost for Bioretention Soil Texture – Compost for bioretention soils shall be analyzed by an accredited lab using #200, 1/4 inch, 1/2 inch, and 1 inch sieves (ASTM D 422 or as approved by municipality), and meet the following gradation:

Sieve Size	Percent Passing (by weight)	
	<i>Min</i>	<i>Max</i>
1 inch	99	100
1/2 inch	90	100
1/4 inch	40	90
No. 200	1	10

- d. Bulk density shall be between 500 and 1100 dry lbs/cubic yard
- e. Moisture content shall be between 30% - 55% of dry solids.
- f. Inerts – compost shall be relatively free of inert ingredients, including glass, plastic and paper, < 1 % by weight or volume.
- g. Select Pathogens – Salmonella <3 MPN/4grams of TS, or Coliform Bacteria <10000 MPN/gram.
- h. Trace Contaminants Metals (Lead, Mercury, Etc.) – Product must meet US EPA, 40 CFR 503 regulations.
- i. Compost Testing – The compost supplier will test all compost products within 120 calendar days prior to application. Samples will be taken using the STA sample collection protocol. (The sample collection protocol can be obtained from the U.S. Composting Council, 4250 Veterans Memorial Highway, Suite 275, Holbrook, NY 11741 Phone: 631-737-4931, [www.compostingcouncil.org](http://www.compostingcouncil.org)). The sample shall be sent to an independent STA Program approved lab. The compost supplier will pay for the test.



### Verification of Alternative Bioretention Soil Mixes

Bioretention soils not meeting the above criteria shall be evaluated on a case by case basis. Alternative bioretention soil shall meet the following specification: “Soils for bioretention facilities shall be sufficiently permeable to infiltrate runoff at a minimum rate of 5 inches per hour during the life of the facility, and provide sufficient retention of moisture and nutrients to support healthy vegetation.”

The following steps shall be followed by municipalities to verify that alternative soil mixes meet the specification:

1. General Requirements – Bioretention soil shall achieve a long-term, in-place infiltration rate of at least 5 inches per hour. Bioretention soil shall also support vigorous plant growth. The applicant refers to the entity proposing the soil mixture for approval.
  - a. Submittals – The applicant must submit to the municipality for approval:
    - (1) A minimum one-gallon size sample of mixed bioretention soil.
    - (2) Certification from the soil supplier or an accredited laboratory that the Bioretention Soil meets the requirements of this guideline specification.
    - (3) Certification from an accredited geotechnical testing laboratory that the Bioretention Soil has an infiltration rate between 5 and 12 inches per hour as tested according to Section 1.b.(2)(ii).
    - (4) Organic content test results of mixed Bioretention Soil. Organic content test shall be performed in accordance with by Testing Methods for the Examination of Compost and Composting (TMECC) 05.07A, “Loss-On-Ignition Organic Matter Method”.
    - (5) Grain size analysis results of mixed bioretention soil performed in accordance with ASTM D 422, Standard Test Method for Particle Size Analysis of Soils.
    - (6) A description of the equipment and methods used to mix the sand and compost to produce Bioretention Soil.
    - (7) The name of the testing laboratory(s) and the following information:
      - (i) Contact person(s)
      - (ii) Address(s)
      - (iii) Phone contact(s)
      - (iv) E-mail address(s)
      - (v) Qualifications of laboratory(s), and personnel including date of current certification by STA, ASTM, or approved equal.
  - b. Bioretention Soil
    - (1) Bioretention Soil Texture: Bioretention Soils shall be analyzed by an accredited lab using #200, and 1/2” inch sieves (ASTM D 422 or as approved by municipality), and meet the following gradation:

Sieve Size	Percent Passing (by weight)	
	<i>Min</i>	<i>Max</i>
1/2 inch	97	100
No. 200	2	5

- (2) Bioretention Soil Permeability testing: Bioretention Soils shall be analyzed by an accredited geotechnical lab for the following tests:
  - (i) Moisture – density relationships (compaction tests) shall be conducted on bioretention soil. Bioretention soil for the permeability test shall be compacted to 85 to 90 percent of the maximum dry density (ASTM D1557).
  - (ii) Constant head permeability testing in accordance with ASTM D2434 shall be conducted on a minimum of two samples with a 6-inch mold and vacuum saturation.

### Mulch for Bioretention Facilities

Use of composted wood mulch, consistent with the new regional Biotreatment Wood Mulch (BWM) specification<sup>1</sup> provided as Attachment K-2, in areas between plantings, is recommended. Installing and maintaining a 3-inch layer of BWM is consistent with the State of California’s Model Water Efficient Landscape Ordinance (see Section 5.7 of this Guide for more details on the MWELO). Rock mulch, such as cobble or gravel, should be used sparingly and only where absolutely necessary. “Micro-bark”, or “gorilla hair” mulches, as well as chipped wood mulch from recycled pallets and dimensional lumber, are not recommended. See Sections 4.9 and 6.3 of the GI Design Guide for more information on mulch.

Biotreatment Wood Mulch can be obtained through soil suppliers or directly from commercial recycling yards – a list is available on the flowstobay website<sup>2</sup> and is updated periodically. It is recommended to apply 1" to 2" of composted mulch, once a year, preferably in June following weeding.

---

<sup>1</sup> <https://www.flowstobay.org/wp-content/uploads/2021/12/Biotreatment-Area-Wood-Mulch-Spec-8-1-21-Final.pdf>

<sup>2</sup> <https://www.flowstobay.org/wp-content/uploads/2021/01/SMCWPPP-Supplier-List-Wood-Mulch-for-Bioretention-Areas-1.pdf>

**Overview:** This specification for composted wood-based mulch was developed for use in engineered stormwater biotreatment areas. The specification provides for a consistent mulch product that enhances water quality; improves water retention and plant health; has been treated to reduce any potential pathogens, insects or invasive weed seeds; and has reduced floating and migration potential. There are three parts of the specification: feedstocks, processing and testing.

**A. Feedstocks:** This mulch shall be derived from plant debris with at least 90% consisting of clean (minimal trash) woody vegetation such as “Arbor Mulch” (i.e., tree trunks, branches, stumps, and brush). Up to 10% by volume may be derived from other clean source-separated feed stocks, such food scraps, and/or other woody materials, such as clean uncoated lumber.<sup>1</sup>

**B. Processing:** These feedstock materials shall be: 1) composted; 2) meet the PFRP (Process to Further Reduce Pathogens) standard to reduce weed seeds, pathogens, and deleterious materials under 14 CA Code of Regs §17868.3 (i.e., reaching the required minimum temperature of 55 degrees Celsius for the required length of time<sup>2</sup>); and 3) screened to meet the specifications in Table 1 below<sup>3</sup>. No dyes or gorilla hair (fiber mulch) shall be used in the finished mulch product.

**C. Testing and laboratory-related requirements:** All testing of the mulch product shall be completed within 120 days prior to delivery to the site by an STA Program-approved laboratory<sup>4</sup>. A 3- to 4-gallon sample of the mulch product shall be submitted to the laboratory for testing, to provide enough fines from the product to complete the specific testing procedures.

**Table 1: Specifications for Composted Wood Mulch for Stormwater Biotreatment Areas**

Property	Test Method/Units <sup>5</sup>		Requirement	
1. pH	TMECC 04.11-A	Elastomeric pH 1:5 slurry method (pH units)	6.0 – 8.5	
2. Soluble salts	TMECC 04.10-A	Electrical conductivity 1:5 slurry method (dS/m or mmhos/cm)	≤ 6.0	
3. Moisture Content	TMECC 03/09-A	Total solids & moisture at 70±5 °C (% wet weight basis)	30-55%	
4. Organic matter content	TMECC 05.07-A	Loss-on-ignition organic matter method (% dry weight basis)	≥ 65	
5. Maturity	TMECC 05.05-A	Germination and vigor (% relative to positive control)	--	
		Seed emergence	≥ 80	
		Seedling vigor	≥ 80	
6. Stability	TMECC 05.08-B	Carbon dioxide evolution rate (mg CO <sub>2</sub> -C/g OM per day)	≤ 5	
7. Pathogen	TMECC 07.01-B	Salmonella (MPN per 4 grams, dry weight basis)	< 3	
8. Pathogen	TMECC 07.01-B	Fecal coliform bacteria (MPN per gram, dry weight basis)	< 1,000	
9. Physical contaminants	TMECC 02.02-C	Human-made inert removal and classification: plastic, glass, and metal (% > 4 mm fraction)	combined total: < 0.5%	
10. Physical contaminants	TMECC 02.02-C	Film plastic: (% > 4 mm fraction)	< 0.1%	
11. Sizing	TMECC 02.02-B	Sample sieving for aggregate size classification (% dry weight basis)	<b>Min</b>	<b>Max</b>
		Pass 3-inch sieve	100%	--
		Pass 2-inch sieve	90%	--
		Pass 3/8-inch sieve	20%	40%

<sup>1</sup> Unacceptable feedstocks: dyed mulches, plywood, laminated wood products, glued laminated timber (Glulam), oriented strand board (OSB), painted wood, stained wood, pressure-treated wood or other treated wood waste (TWW), or any other manufactured wood products with non-wood ingredients, such as adhesives, or wood treated with chemicals of any kind. Metal concentrations in compost must not exceed the maximum listed in 14 CA Code of Regs §17868.2.

<sup>2</sup> <https://govt.westlaw.com/calregs> (§17868.3. Pathogen Reduction)

<sup>3</sup> Based on the Caltrans specification for “Coarse Compost” with modifications for use in biotreatment systems.

<sup>4</sup> List of approved testing laboratories: [www.compostingcouncil.org/page/CertifiedLabs](http://www.compostingcouncil.org/page/CertifiedLabs)

<sup>5</sup> TMECC refers to “Test Methods for the Examination of Composting and Compost,” published by the United States Department of Agriculture and the United States Compost Council (USCC).

# Appendix L: Site Design Requirements for Small Projects

L.1 Permit Requirements for Small Projects.....	L-2
L.2 Regional Guidance for Site Design Measures.....	L-2
L.3 Selecting Site Design Measures .....	L-3
L.4 Selecting Site Design Measures for Constrained Sites .....	L-6

### L.1 Permit Requirements for Small Projects

Certain small projects are required to meet site design requirements in Provision C.3.i of the Municipal Regional Stormwater Permit (MRP). Since July 1, 2023, projects that create and/or replace at least 2,500 square feet but less than 5,000 square feet of impervious surface, and detached single family home projects<sup>1</sup> that create and/or replace at least 2,500 square feet but less than 10,000 square feet of impervious surface, must implement at least one of the following site design measures:

- Direct roof runoff into cisterns or rain barrels for use;
- Direct roof runoff onto vegetated areas;
- Direct runoff from sidewalks, walkways, and/or patios onto vegetated areas;
- Direct runoff from driveways/uncovered parking lots onto vegetated areas;
- Construct sidewalks, walkways, and/or patios with permeable surfaces; and/or
- Construct bike lanes, driveways, and/or uncovered parking lots with permeable surfaces.

#### Do the Requirements Apply to This Project?

The new requirements apply to the project if it meets the size thresholds described above, and it receives **final discretionary approval on or after July 1, 2023**. If the project does not require discretionary approval, such as tract map approval, conditional use permit, or design review, then the requirements apply if the building permit is issued on or after July 1, 2023.

Please note that projects that create and/or replace 5,000 square feet or more of impervious surface, and detached single family homes that create and/or replace 10,000 square feet or more of impervious surface, are required to implement stormwater treatment, source control measures, AND site design measures.

Consistent with Provision C.3.b, **interior remodels and routine maintenance or repair are excluded from the Provision C.3.i requirements**, including:

- Roof replacement, including those that remove the entire roof.
- Exterior wall surface replacement.

Some types of pavement maintenance are also excluded, but other types **are included** in the calculation of impervious surface created and/or replaced. See Chapter 2 of this Guide for more information.

### L.2 Regional Guidance for Site Design Measures

To assist with selecting and designing site design measures appropriate for the project site, the Countywide Program collaborated regionally through the Bay Area Stormwater Management Agencies Association (BASMAA) to develop four fact sheets that provide guidance regarding the six site design measures listed

---

<sup>1</sup> A detached single-family home project is the building of one single new house or the addition and/or replacement of impervious surface to one single existing house, which is not part of a larger plan of development.

## L.3 Selecting Site Design Measures

above. Table L-1 shows how the fact sheets, which are included at the end of this appendix, correspond with the six site design measures.

<b>Fact Sheet</b>	<b>Corresponding Site Design Measures listed in Provision C.3.i</b>
Managing Stormwater in Landscapes	<ul style="list-style-type: none"> <li>▪ Direct roof runoff onto vegetated areas.</li> <li>▪ Direct runoff from sidewalks, walkways, and/or patios onto vegetated areas.</li> <li>▪ Direct runoff from driveways/uncovered parking lots onto vegetated areas.</li> </ul>
Rain Gardens	<ul style="list-style-type: none"> <li>▪ Corresponds to the same site design measures as “Managing Stormwater in Landscapes” above. Differences between rain gardens and other landscaped area include:</li> <li>▪ Applicants may choose to select a rain garden if they want to capture and infiltrate more stormwater in a smaller area than is possible with most native soils.</li> <li>▪ Rain gardens should have well-drained soil; soil amendments may be needed.</li> <li>▪ An underdrain may be required if native soils are slow draining.</li> </ul>
Pervious Paving	<ul style="list-style-type: none"> <li>▪ Construct sidewalks, walkways, and/or patios with permeable surfaces.</li> <li>▪ Construct bike lanes, driveways, and/or uncovered parking lots with permeable surfaces.</li> </ul>
Rain Barrels and Cisterns	<ul style="list-style-type: none"> <li>▪ Direct roof runoff into cisterns or rain barrels for use.</li> </ul>

### *L.3 Selecting Site Design Measures*

To supplement guidance provided in the regional fact sheets, refer to Table L-2 to identify key opportunities and constraints for the site design measures listed in Provision C.3.i. One or more site design measures that are a good match for the project site should be chosen. Only one site design measure is required, but additional measures may be implemented to increase the water quality benefits of the project.

*Table L-2: Opportunities and Constraints for Site Design Measures*

Site Design Measure	Opportunities	Constraints	Guidance to Address Constraints
Managing Stormwater in Landscapes	<ul style="list-style-type: none"> <li>▪ Low areas.</li> <li>▪ Flat areas or minimal slope.</li> </ul>	<ul style="list-style-type: none"> <li>▪ Steep slopes</li> <li>▪ Insufficient space for landscaping</li> </ul>	<ul style="list-style-type: none"> <li>▪ Avoid on steep slopes where increased infiltration may undermine slope.</li> <li>▪ Landscaped area should be at least half the size of the impervious area draining to it.</li> <li>▪ Direct runoff away from building foundations.</li> </ul>
Rain Gardens	<ul style="list-style-type: none"> <li>▪ Low areas.</li> <li>▪ Flat areas or minimal slope.</li> <li>▪ Well-drained soil</li> <li>▪ Existing storm drain to tie in underdrain (if underdrain is needed)</li> </ul>	<ul style="list-style-type: none"> <li>▪ Steep slopes</li> <li>▪ Insufficient space for landscaping</li> <li>▪ Poorly drained soil</li> </ul>	<ul style="list-style-type: none"> <li>▪ Avoid on steep slopes.</li> <li>▪ Rain garden should be at least 4% of the size of the impervious area draining to it.</li> <li>▪ If soils do not drain well, consider soil amendments.</li> <li>▪ An underdrain may be needed if native soils are clayey.</li> <li>▪ Recommended setbacks: 10 ft. from building foundation and 5 ft. from property line</li> </ul>

### L.3 Selecting Site Design Measures

Site Design Measure	Opportunities	Constraints	Guidance to Address Constraints
Pervious Paving	<ul style="list-style-type: none"> <li>▪ Flat areas or minimal slope.</li> <li>▪ Well-drained soil</li> <li>▪ Existing storm drain to tie in underdrain (if underdrain is needed).</li> </ul>	<ul style="list-style-type: none"> <li>▪ Steep slopes</li> <li>▪ Poorly drained soils</li> <li>▪ Buildings close to pavement</li> </ul>	<ul style="list-style-type: none"> <li>▪ Avoid use on 5% slopes and greater, unless municipality approves use of underdrain.</li> <li>▪ Underdrain may be needed if native soils are clayey.</li> <li>▪ Install away from buildings, or provide impermeable barrier.</li> </ul>
Rain Barrels and Cisterns	<ul style="list-style-type: none"> <li>▪ Roof area that drains to downspouts.</li> <li>▪ Flat, firm area near the building for rain barrel or cistern.</li> <li>▪ Landscaping that is downslope from rain barrel or cistern, allowing gravity flow of water for irrigation and discharge of overflow.</li> </ul>	<ul style="list-style-type: none"> <li>▪ Lack of landscape that requires irrigation.</li> <li>▪ Irrigation system that requires high water pressure.</li> <li>▪ Absence of flat, firm area near the building.</li> <li>▪ Lack of suitable areas to receive overflow</li> </ul>	<ul style="list-style-type: none"> <li>▪ Interior non-potable use may be considered, if allowed by municipality.</li> <li>▪ Use with low-pressure irrigation systems.</li> <li>▪ Ensure adequate space to safely install rain barrel or cistern and accommodate overflow.</li> </ul>



### *L .4 Selecting Site Design Measures for Constrained Sites*

Provision C.3.i does not allow for findings of infeasibility or impracticability, nor does it provide alternative compliance or in-lieu options. Therefore, one of the six site design measures must be implemented in applicable projects, even on sites with constraints such as those identified in Table L-2.

If the project site has constraints such as poorly draining soils, steep slopes, or limited space for landscaping, consult with municipal staff regarding approaches to incorporating the site design measures within the constrained site.

## Design Checklist

- ❑ Maximize the use of landscaping and natural areas that already exist. Try to design new landscapes immediately adjacent to impervious surfaces.
- ❑ Water should flow evenly (without concentrating runoff into small streams) from the impervious surface to the landscape; this will maximize the filtration and settling of sediment and pollutants and prevent erosion. The design should avoid allowing straight channels and streams to form.
- ❑ Amend soils to improve drainage, when necessary.
- ❑ If the project is located next to standard asphalt or concrete pavement, and there is concern about water undermining the pavement, include a water barrier in the design.
- ❑ Use curb cuts to create places where water can flow through to the landscape.
- ❑ Disconnect roof downspouts and redirect flow to adjacent landscapes. Disconnected downspout systems should incorporate a splash block to slow the runoff flow rate; a landscape flow path length of 10 to 15 feet is recommended.
- ❑ Use drought-tolerant native or climate-adapted plant species whenever possible. Avoid invasive or pest species. A list of invasive species may be found at the California Invasive Plant Council website ([www.cal-ipc.org](http://www.cal-ipc.org)). Contact municipal staff for a list of plants suitable for stormwater management areas.
- ❑ Design the landscape area so that overflow from large storms discharges to another landscaped area or the storm drain system to prevent flooding.

## Maintain Your Landscape

The following practices will help maintain your landscape to keep it attractive and managing stormwater runoff effectively.

- ❑ During dry months, irrigate during the first year to encourage root growth and establish the plants. In subsequent years, irrigate as needed by the plant species to maintain plant health.
- ❑ Repair signs of erosion immediately and prevent further erosion by reinforcing the surrounding area with ground cover or using rocks for energy dissipation.
- ❑ If standing water remains in the landscaped area for more than 4 days, use soil amendments to improve infiltration.
- ❑ Inspect the locations where water flows into a landscaped area from adjacent pavement to ensure that there is positive flow into the landscape, and vegetation or debris does not block the entrance point.



*The City of Los Angeles and Geosyntec Consultants are acknowledged for providing text, formatting and various images used in this fact sheet. The Sonoma Valley Groundwater Management Program, San Mateo Countywide Water Pollution Prevention Program, City of San Jose, Sacramento Stormwater Quality Partnership, and the Purissima Hills Water District are acknowledged for images used in the fact sheet.*

# LANDSCAPE DESIGNS FOR STORMWATER MANAGEMENT

## Stormwater Control for Small Projects



Bay Area Stormwater Management Agencies Association



*Dry creek infiltrates and conveys runoff.*

Designing landscaped areas to soak up rainfall runoff from building roofs and paved areas helps protect water quality in local creeks and waterways. These landscape designs reduce polluted runoff and help prevent creek erosion.

As the runoff flows over vegetation and soil in the landscaped area, the water percolates into the ground and pollutants are filtered out or broken down by the soil and plants.

This fact sheet shows how you can design your landscape to absorb runoff from impervious surfaces, such as roofs, patios, driveways, and sidewalks, with landscape designs that can be very attractive.

If you are interested in capturing and storing water for irrigation use, see the Rain Barrel fact sheet in this series.

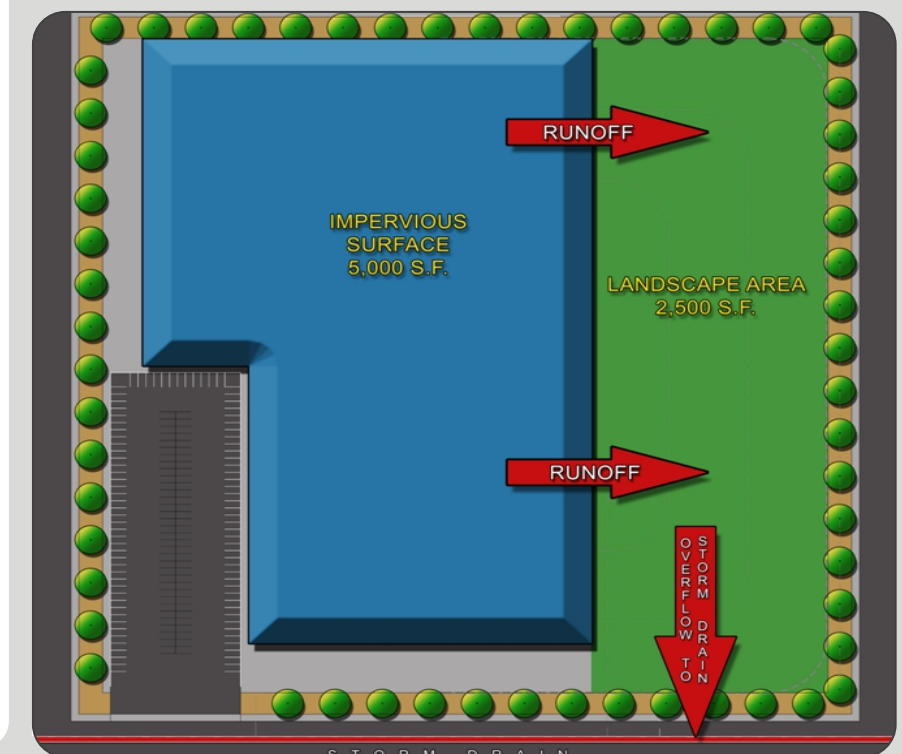
## Can My Project Manage Stormwater in the Landscape?

Directing stormwater runoff to the landscape is suitable for sites with the following conditions:

- Roofs, driveways, parking areas, patios, and walkways that can drain to an existing landscape, or an area that may be converted to landscape.
- Areas of landscape with a slope of 5% or less are preferred; check with the municipality regarding requirements for steeper sites.
- Works best in well-drained soil; soil amendments may be used in areas with poor drainage.
- Landscaped areas that total at least 1/2 the size of the impervious area draining to it.
- Direct runoff away from building foundations.
- Runoff should not create ponding around trees and plants that won't tolerate wet conditions.

## How Do I Size My Landscape?

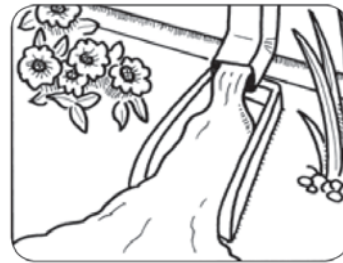
The landscaped area should be 50% of the size of the contributing impervious surface. For example (see below), to manage runoff from a 5,000 square foot roof or paved surface, you should have 2,500 square feet of landscaping.



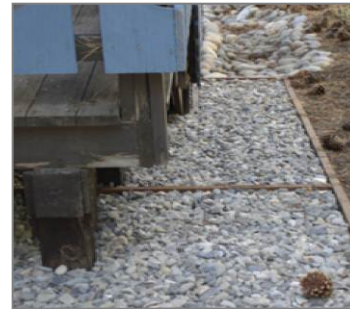
## Techniques to Manage Stormwater in Landscaping

### Direct Roof Runoff to Landscape

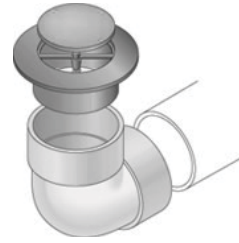
- Use additional piping to connect the downspout to the landscape if needed.
- Direct runoff away from building foundation.
- Prevent erosion by installing:
  - Splash blocks,
  - Rain chains,
  - Gravel area under a gutterless roof,
  - Pop-up drainage emitter connected to a pipe that carries runoff away from the foundation, or
  - Other energy dissipation technique.



Splash block



Gravel area under a gutterless roof



Pop-up emitter



Rain chain

### Swales or Dry Creeks



Cross section

Swales and dry creeks are narrow, linear depressions designed to capture and convey water. Swales imitate a natural creek's ability to slow, infiltrate, and filter stormwater. To install a swale follow these steps:

- Excavate a narrow linear depression that slopes down to provide a flow path for runoff. The path length (10 to 15 feet or more) should meander to slow water and prevent erosion.
- Use plants from creek and river ecosystems to help reduce erosion and increase evaporation of runoff.
- The end of the swale requires an outlet for high flows (another landscaped area or a yard drain). Talk to municipal staff to identify an appropriate discharge location.
- Contact municipal staff for a local list of plants suitable for swales.



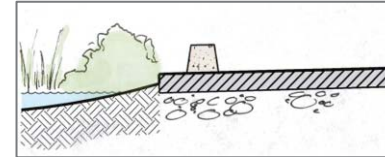
## Techniques to Manage Stormwater in Landscaping

### Direct Parking Lot Runoff to Landscape

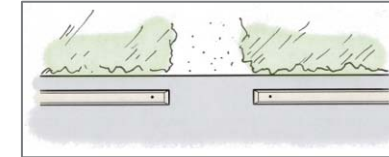


During storms, parking lots generate large amounts of runoff, which picks up oils, grease, and metals from vehicles. Landscaped areas can be designed to absorb and filter this runoff.

- Landscaped areas must be below the paved elevation. Allow an elevation change of 4 to 6 inches between the pavement and the soil, so that vegetation or mulch build-up does not block the flow.
- Grade the paved area to direct runoff towards the landscaping.
- If possible, provide a long path for runoff to infiltrate (while meeting the landscaped area sizing on page 1).
- Provide multiple access points for runoff to enter the landscape. Install curb cuts or separate wheel stops for the water to flow through. Provide cobbles or other permanent erosion control at points of concentrated flow.



Cross section

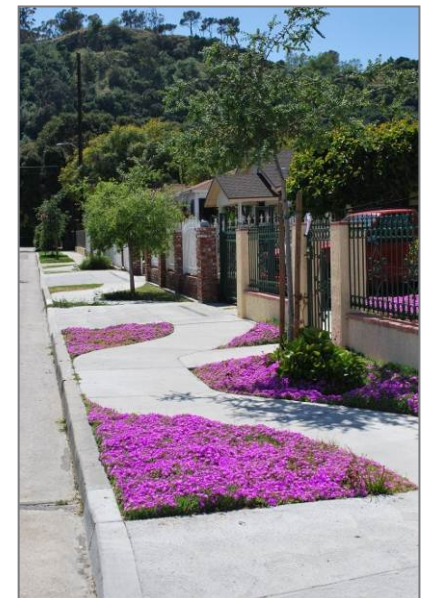


View from above

### Manage Runoff from Driveways/Small Paved Areas

Driveways, sidewalks, patios, walkways, and other small paved areas can offer creative opportunities to drain runoff to landscaping.

- Install landscape adjacent to the paved surface, and grade the paved area so runoff flows toward the landscaping.
- Landscaped areas must be below the paved elevation. Allow an elevation change of 4 to 6 inches between the pavement and the soil, so that vegetation or mulch build-up does not block the flow.
- Install cobbles or rocks where runoff enters the landscape to avoid erosion.
- Use sizing ratio described on page 1.
- Use drought-tolerant native or climate-adapted plants to reduce irrigation.



## Design Checklist

When installing a rain garden, the following design considerations are recommended.

- ❑ Locate the rain garden at least 10 feet from home foundation, 3 feet from public sidewalks, and 5 feet from private property lines. If rain gardens need to be located closer to buildings and infrastructure, use an impermeable barrier.
- ❑ Locate the rain garden to intercept and collect runoff from a roof downspout or adjacent impervious area.
- ❑ Size the rain garden appropriately based on the soil type and drainage area (see Page 1).
- ❑ Do not locate the rain garden over septic systems or shallow utilities. Locate utilities before digging by calling Dig Alert at (888) 376-3314.
- ❑ Locate the rain garden on a relatively flat area, away from steep slopes. If you plan on moving a large quantity of soil, you may need a grading permit. Contact your local municipality for further assistance.
- ❑ Consider installing an underdrain to enhance infiltration in very clayey soils. Contact municipal staff for guidance on how to properly install an underdrain.
- ❑ An overflow should be incorporated in the rain garden to move water that does not infiltrate to another pervious area and away from the home's foundation or neighboring property.
- ❑ Drought and flood resistant native plants are highly recommended and a variety of species should be planted. Avoid invasive plants. Contact municipal staff for a list of plants appropriate for rain gardens from the applicable countywide stormwater guidance. A list of invasive species may be found at the California Invasive Plant Council website ([www.cal-ipc.org](http://www.cal-ipc.org)).

## Maintenance Considerations

Once a rain garden is installed, the following steps will help the garden function effectively.

- ❑ Rain gardens should be irrigated periodically (as needed) during dry months, especially while plants are being established. Plants should be inspected for health and weeds should be removed as often as necessary.
- ❑ Apply about 2 inches of mulch and replace as needed. Mulch with a material that will not float away such as compost or a larger sized hardwood mulch (avoid microbark, for example).
- ❑ Areas of erosion should be repaired. Further erosion can be prevented by stabilizing the eroding soil with ground cover or using energy dispersion techniques (e.g., splashblock or cobbles) below downspouts.
- ❑ Avoid using synthetic fertilizers or herbicides in your rain garden because these chemicals are water pollutants.
- ❑ Standing water should not remain in a rain garden for more than 3 days. Extended periods of flooding will not only kill vegetation, but may result in the breeding of mosquitos or other vectors.



*The City of Los Angeles and Geosyntec Consultants are acknowledged for providing text, formatting and various images used in this fact sheet. Contra Costa County is acknowledged for an image used in the fact sheet.*

# RAIN GARDENS

## Stormwater Control for Small Projects



Bay Area Stormwater  
Management Agencies  
Association



Large Residential Rain Garden

Rain gardens are landscaped areas designed to capture and treat rainwater that runs off roof and paved surfaces. Runoff is directed toward a depression in the ground, which is planted with flood and drought-resistant plants. As the water nourishes the plants, the garden stores, evaporates, and infiltrates rainwater into the soil. The soil absorbs runoff pollutants, which are broken down over time by microorganisms and plant roots.

Rain gardens are a relatively low-cost, effective, and aesthetically pleasing way to reduce the amount of stormwater that runs off your property and washes pollutants into storm drains, local streams, and the San Francisco Bay. While protecting water quality, rain gardens also provide attractive landscaping and habitat for birds, butterflies, and other animals, especially when planted with native plants.

## Is a Rain Garden Feasible for My Project?

Rain gardens are appropriate where the following site characteristics are present:

- Rain gardens should be installed at least 10 feet from building foundations. The ground adjacent to the building should slope away at a 2% minimum slope. A downspout extension or "swale" (landscaped channel) can be used to convey rain from a roof directly into a rain garden. Rain gardens can also be located downstream from a rain barrel overflow path.
- Rain gardens should be at least 3 feet from public sidewalks (or have an appropriate impermeable barrier installed), 5 feet from property lines, and in an area where potential overflow will not run onto neighboring properties.
- The site should have well-drained soil and be relatively flat. Soil amendments can improve infiltration in areas with poor drainage. Add about 3 inches of compost to any soil type and till it in to a depth of about 12 inches.
- A front or backyard can work well for a rain garden, especially in areas where the slope naturally takes the stormwater.

## How Large Does My Rain Garden Need to Be?

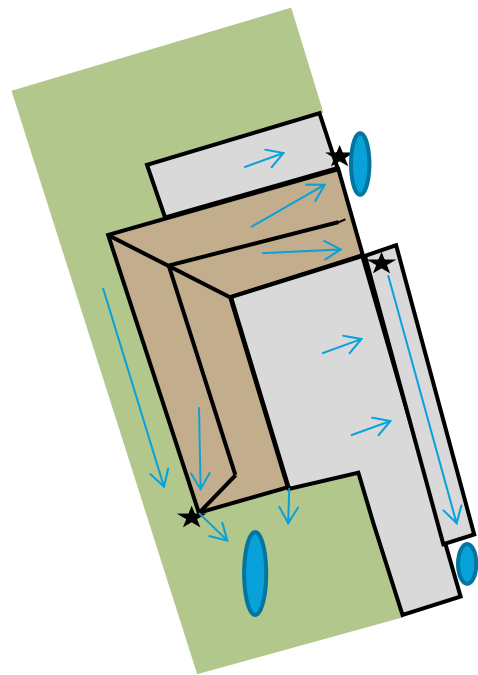
A general recommendation for a garden with a 6-inch ponding depth is to size the rain garden to approximately 4% of the contributing impervious area. Your soil type will affect how the rain garden should be sized because the water infiltration rate depends on the soil type; rain gardens should be larger in areas with slower infiltration. The following table can be used as general guidance.

Contributing Area (sq. ft.)	Rain Garden Area (sq. ft.)
500 – 700	24
701 – 900	32
901 – 1,100	40
1,101 – 1,300	48
1,301 – 1,500	56
1,501 – 2000*	70

\*Projects adding roof or other impervious areas in excess of 2,000 sq. ft. should add 20 sq. ft. of rain garden surface area per every 500 sq. ft. of additional area.

## How to Plan and Install a Rain Garden

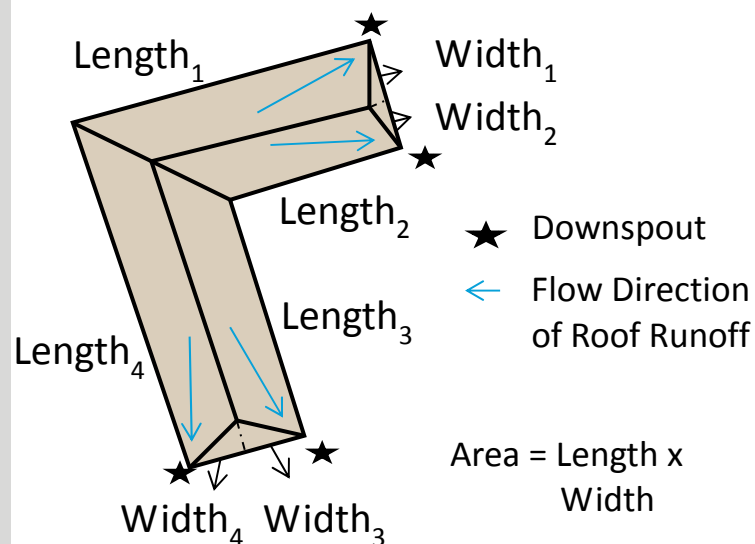
### Select a Location and Plan for Overflow



- Vegetated Surface
- Paved Surface
- Downspout
- Runoff Direction
- Potential Rain Garden Locations
- Roof Surface

- Before choosing the location of your rain garden, observe how rainwater is distributed across your home and yard. The ideal rain garden location is a flat or gently sloped area and is down slope from a runoff source.
- Site your garden at least 10 feet away from any structures (unless an impermeable barrier is used) and 5 feet from property lines.
- Avoid siting your garden over underground utilities and septic systems, near large trees, or next to a creek, stream or other water body.
- Your rain garden will overflow in large storms. Therefore, all garden designs should include an overflow system. One option is to build the perimeter of the garden so that it is perfectly level and to allow water to gently spill over the top during large storms. Another option is to build in a spillway that connects to another landscaped area, or the storm drain system.

### Plan the Size of Your Rain Garden



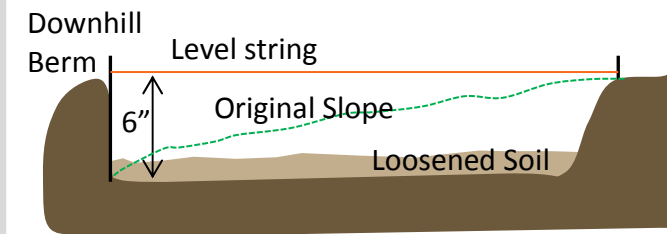
Area = Length x Width

- Once you have determined where your garden will be sited, look at the surrounding area and identify which surfaces will contribute runoff to the garden. Is it all or just a part of the roof, patio, or driveway?
- Estimate the roof area by measuring the length and width of the building foundation and adding a few inches for the overhang. Multiply the length times the width to determine the contributing area. Once you have calculated the area of each contributing surface, add them up to obtain the total contributing area.
- Refer to the chart on page 1 to identify the size of the rain garden you will need to manage runoff from the contributing area.

If you do not have the space, budget, or interest in building a garden of this size, you may consider capturing some of your roof runoff in rain barrels to reduce the amount of runoff, or discharge the overflow to another landscaped area.

## How to Plan and Install a Rain Garden

### Install your Rain Garden



- Once you have selected a site and planned the size of your rain garden, lay out the shape using a string or tape to define the outline of where you will dig.
- If the yard is level, dig to a depth of 6-inches and slope the sides. If the site is sloped, you may need to dig out soil on the uphill side of the area and use the soil to construct a small berm (a compacted wall of soil) along the down slope side of the garden.
- Use a string level to help level the top of the garden and maintain an even 6-inch depth.
- Once the garden is excavated, loosen the soil on the bottom of the area so you have about 12 inches of soft soil for plants to root in. Mix in about 3 inches of compost to help the plants get established and improve the water-holding capacity of the soil.
- If water enters the garden quickly, include a layer of gravel or river rock at the entry points to prevent erosion.

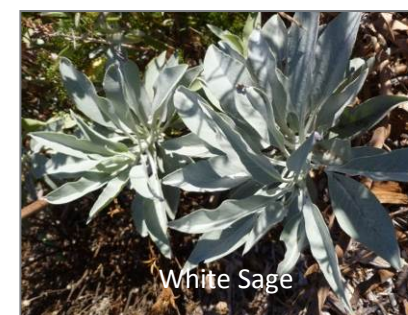
### Select Appropriate Plants



California Fuchsia



Common Rush



White Sage



Douglas Iris

You can design your rain garden to be as beautiful as any other type of garden. Select plants that are appropriate for your location and the extremes of living in a rain garden

Site Considerations:

- How much light will your garden receive?
- Is your property near the coast or located in an inland area (this affects sun and temperature)?
- Are there high winds near your home?

Recommended plant characteristics:

- Native plants adapted to local soil and climate,
- Drought tolerant,
- Flood tolerant,
- Not invasive weedy plants,
- Non-aggressive root systems to avoid damaging water pipes,
- Attracts birds and beneficial insects.

\*Contact municipal staff to obtain a full list of recommended plants, provided in the countywide stormwater guidance.

## Design Checklist

When installing pervious pavement, the following design criteria should be considered.

- ❑ An open-graded base of crushed stone, which has 35 to 45 percent pore space, is installed below the surface pavement. The recommended base thickness is 6 inches for pedestrian use and 10 inches for driveways to provide adequate structural strength.
- ❑ Slope is flat or nearly flat (not greater than 2 percent).
- ❑ Flow directed to pervious pavement is dispersed so as not to be concentrated at a small area of pavement.
- ❑ No erodible areas drain onto the pavement.
- ❑ The subgrade is uniform and compaction is the minimum required for structural stability.
- ❑ If a subdrain is provided, its outlet elevation is a minimum of 3 inches above the bottom of the base course.
- ❑ A rigid edge is provided to retain granular pavements and unit pavers.
- ❑ If paving is close to a building, a barrier or impermeable liner may be required to keep water away from the building foundation.
- ❑ Pavers have a minimum thickness of 80 mm (3 1/8 inches) and are set in sand or gravel with minimum 3/8-inch gaps between pavers.
- ❑ Proprietary products must be installed per the manufacturer's specifications.
- ❑ The project complies with applicable sections of the current municipal code, including disabled access requirements and site drainage requirements, if applicable.

## Maintenance Considerations

Once pervious pavement is installed, the following maintenance criteria should be followed:

- ❑ The use of leaf blowers on permeable pavement can force dirt and debris into pavement void spaces. Avoid blowing leaves, grass trimmings and other debris across permeable pavement.
- ❑ Remove weeds from pavement and replace missing sand or gravel between pavers as needed.
- ❑ Inspect subdrain outlets (if applicable) yearly to verify they are not blocked.
- ❑ Inspect pavement after rains for ponding or other visible problems. If there are problems with standing water, vacuum sweeping with specialized equipment may be required. Concrete grid pavers do not require sweeping.



Open Joint Pavers

*The City of Los Angeles and Geosyntec Consultants are acknowledged for providing text, formatting and various images used in this fact sheet. The Interlocking Concrete Pavement Institute is acknowledged for contributing pavement sections, design details and specifications. The San Mateo Countywide Water Pollution Prevention Program, Santa Clara Valley Urban Runoff Pollution Prevention Program, and City of San Jose are acknowledged for images used in the fact sheet.*

# PERVIOUS PAVEMENT

## Stormwater Control for Small Projects



Bay Area Stormwater  
Management Agencies  
Association



Permeable Interlocking Concrete  
Pavers

Pervious pavement, also referred to as permeable pavement, contains pores or separation joints that allow water to flow through and seep into a base material (typically gravel or drain rock). Types of pervious pavement include porous asphalt and concrete, open joint pavers, interlocking concrete or permeable pavers, and plastic or concrete grid systems with gravel-filled voids.

Pervious pavement systems allow infiltration of stormwater into soils, thereby reducing runoff and the amount of pollutants that enter creeks, San Francisco Bay, the Pacific Ocean, and other water bodies. This improves water quality, helps reduce creek erosion, and can facilitate groundwater recharge. Pervious pavement is available in many different types that offer environmentally-friendly and aesthetically pleasing options for driveways, walkways, parking areas, and patios.

## Is Pervious Pavement Feasible for My Project?

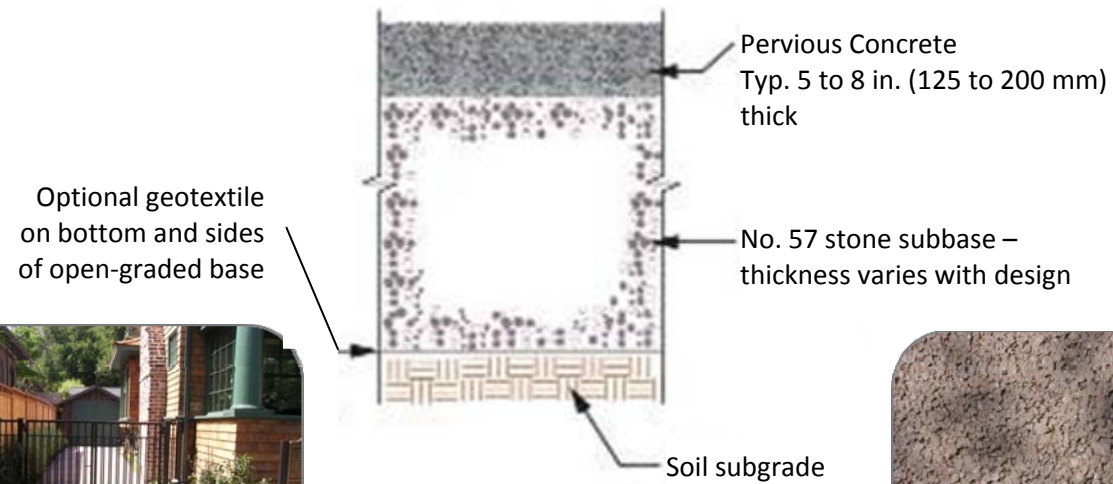
Pervious pavement is appropriate in locations with the following characteristics:

- The location is flat or nearly flat (a maximum 2% slope).
- The location is not in a seasonally wet area.
- The location is not close to a building foundation, unless measures are taken to prevent infiltration under the structure. (See Design Checklist.)



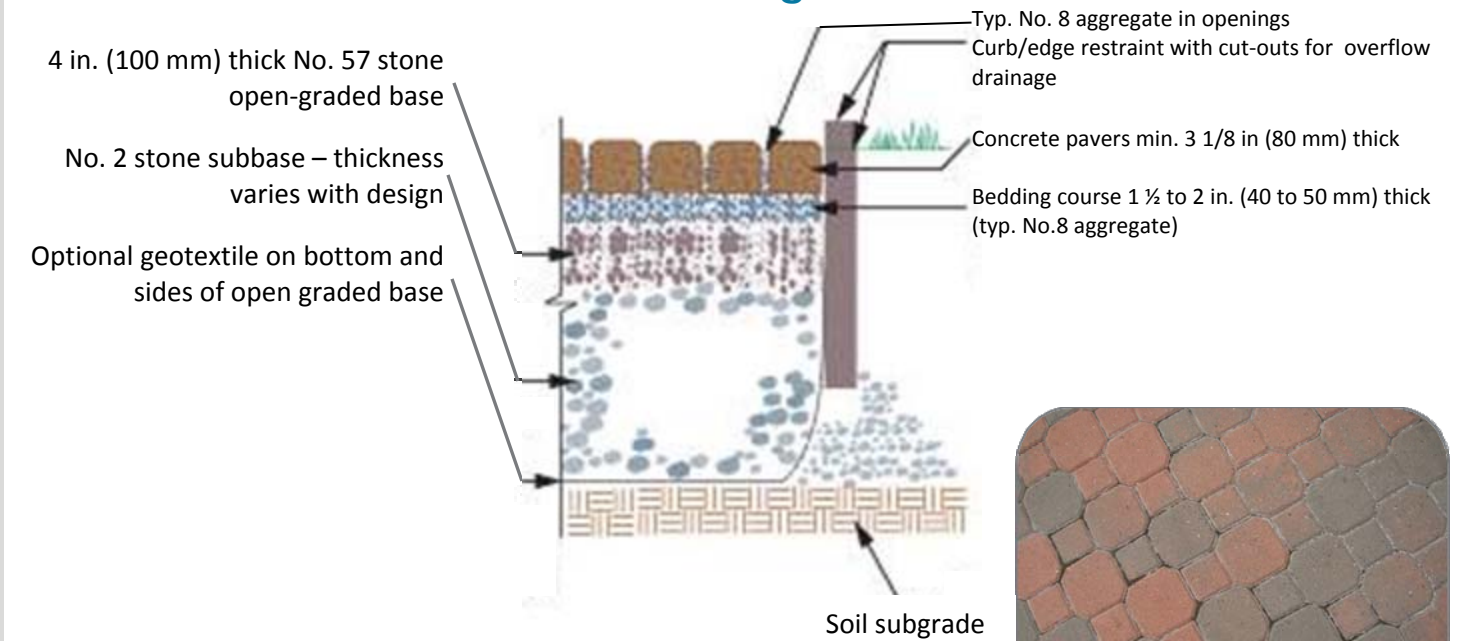
## Typical Materials and Example Applications

### Pervious Concrete



## Typical Materials and Example Applications

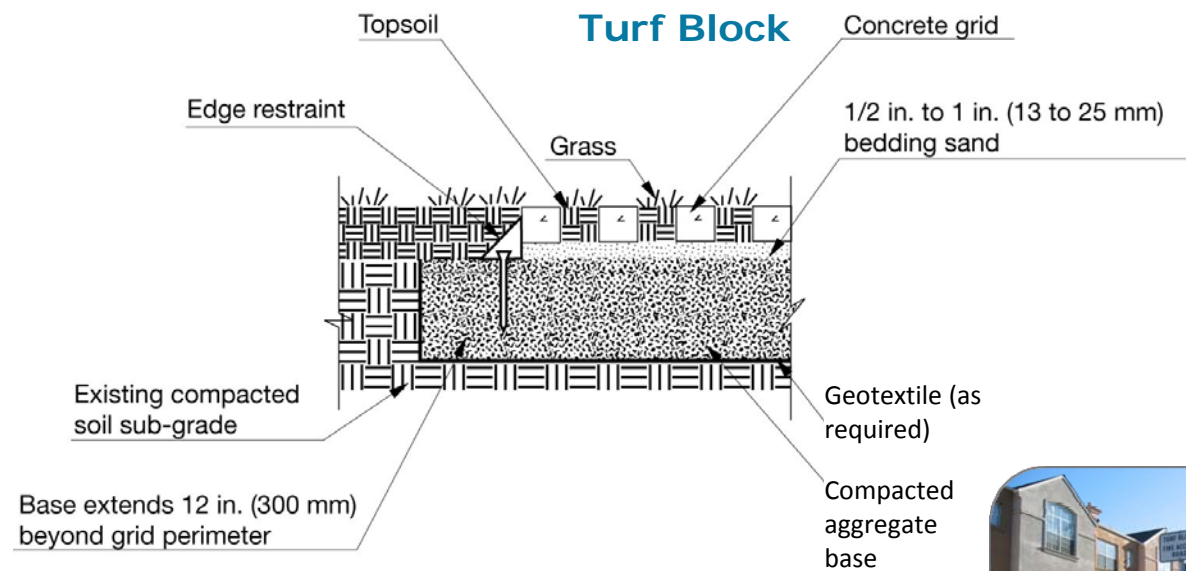
### Permeable Interlocking Concrete Pavers



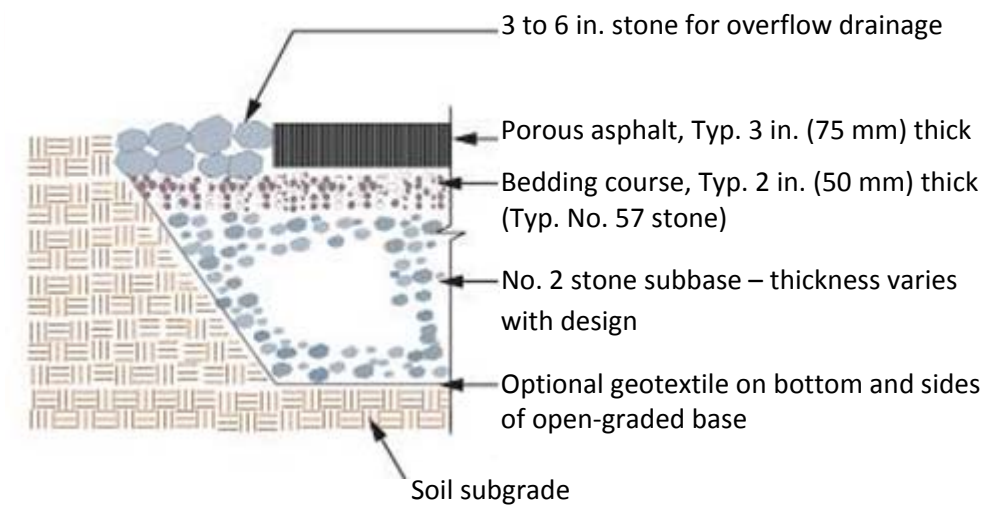
Note: ASTM No. 3 or 4 stone may be substituted for No. 2 stone.  
ASTM No. 89 or 9 stone may be used in the paver openings.



### Turf Block



### Porous Asphalt



Note: ASTM No. 3 or 4 stone may be substituted for No. 2 stone.  
ASTM No. 89 or 9 stone may be used in the paver openings.



## Design Checklist

When installing rain barrels and cisterns, consider the following criteria unless otherwise instructed by the municipality.

- ❑ Do not use flexible piping, to prevent mosquito breeding in water that may pool in flexible pipes. If irrigating edible landscapes, consider pipes that meet FDA food grade standards.
- ❑ When designing the overflow path, remember that in heavy storms rain barrels and cisterns *will* overflow. A 1,000-sq.-ft. roof will produce about 600 gallons of runoff during a storm that has produces a depth of 1 inch of rain.
- ❑ There shall be no direct connection of any rain barrel or cistern and/or rainwater collection piping to any potable water pipe system. Rainwater systems shall be completely separate from potable water piping systems.
- ❑ Place the bottom of the barrel at a higher elevation than the landscape, to use gravity flow.
- ❑ All rain barrels and cisterns should have a screen to ensure mosquitoes cannot enter.
- ❑ Allow overflow to drain to your landscape or a rain garden. Ensure that areas receiving overflow do not have standing water for more than 48-hours.
- ❑ The low water pressure from a small rain barrel will not operate in-ground sprinkler or low-volume devices. Consider using a soaker hose.
- ❑ If using a soaker hose, remove the pressure-reducing washer to increase the water flow.
- ❑ If the water is not needed for irrigation during the rainy season, consider releasing the water to a vegetated area between storms, so the barrels will be empty to catch rain from the next storm. This will help protect your watershed by reducing the quantity and speed of water entering local creeks during storms. Install a spigot and drip tape to allow the rain barrel or cistern to slowly drain between storms. You can store the water captured towards the end of the rainy season to irrigate your garden in the dry season.
- ❑ For more information, ask municipal staff to refer you to countywide stormwater guidance.

## Operation and Maintenance

After installing your rain barrel or cistern, follow these tips for long-term safety and functionality.

- ❑ Regularly check the gutters and gutter guards to make sure debris is not entering the rainwater harvesting system.
- ❑ Inspect the screens on the rain barrel or cistern prior to the wet season to make sure debris is not collecting on the surface and that there are not holes allowing mosquitoes to enter the rain barrel. Inspect screens more frequently if there are trees that drop debris on the roof.
- ❑ Clean the inside of the rain barrel once a year (preferably at the end of the dry season when the rain barrel has been fully drained) to prevent buildup of debris. If debris cannot be removed by rinsing, use vinegar or another non-toxic cleaner. Use a large scrub brush on a long stick, and avoid actually entering the rain barrel. Drain washwater to landscaping.
- ❑ Clean out debris from cisterns once a year, preferably at the end of the dry season.



Daisy-chained system  
Courtesy of Acterra

*The City of Los Angeles and Geosyntec Consultants are acknowledged for providing text and formatting used in this fact sheet. The City of Oakland, Acterra, Gutter Glove, and Stephanie Morris are acknowledged for images used in the fact sheet.*

# RAIN BARRELS AND CISTERNS

## Stormwater Control for Small Projects



Bay Area Stormwater  
Management Agencies  
Association



Daisy chained system of 205-gallon rain barrels  
Courtesy of The City of Oakland

Rain barrels and cisterns can be installed to capture stormwater runoff from rooftops and store it for later use. They are low-cost systems that will allow you to supplement your water supply with a sustainable source and help preserve local watersheds by detaining rainfall.

Collected rainwater may be used for landscape irrigation. Subject to permitting requirements, harvested rainwater may be allowed for toilet flushing; contact municipal staff for more information. Capturing even a small amount of your roof runoff will have environmental benefits because it will reduce the quantity and speed of stormwater runoff flowing to local creeks.

Rain barrels typically store between 50 and 200 gallons. They require very little space and can be connected or "daisy chained" to increase total storage capacity.

Cisterns are larger storage containers that can store 200 to over 10,000 gallons. These come in many shapes, sizes, and materials, and can be installed underground to save space.

### How Much Storage is Recommended?

The number of rain barrels recommended to capture runoff from a given roof (or other impervious area) is shown in the following table.

### Are Rain Barrels or Cisterns Feasible for My Project?

Rain barrels and cisterns are appropriate for sites with the following characteristics:

- Roof areas that drain to downspouts.
- A level, firm surface is needed to support a rain barrel(s) or cistern to prevent shifting or falling over. A full 55-gallon rain barrel will weigh over 400 lbs.
- A landscaped area where the captured water can be used (and where it can be drained by gravity flow) should be located within a reasonable distance from the rain barrel(s).
- A landscaped area or safe path to the storm drain system that can handle overflow.

Roof or Impervious Area (sq. ft.)	Suggested Minimum Number of 55 Gallon Rain Barrels*
Up to 750	1-2
750 – 1,250	2-3
1,250 – 1,750	3-4
1,750 – 2,250**	4-5

\* Or equivalent capture using larger rain barrels or a cistern.

\*\* To harvest rainwater from an area greater than 2,250 sq. ft. install 1 additional rain barrel per each additional 500 sq. ft.



## Components of a Rainwater Harvesting System

### Roofing Materials



Wood shingle roof  
Courtesy of Gutter Glove

Technically, any impervious surface can be used for harvesting rainwater; however, the surface materials will affect the quality of captured rainwater, which has implications for the recommended uses.

Although it is technically possible to harvest runoff from parking lots, patios, and walkways, it is more difficult since a subterranean cistern or a pump is usually needed to move the water into an above-ground rain barrel or cistern. Also, there are typically greater levels of debris and contaminants that must be filtered out of the runoff before it enters the storage system. Due to these complexities, it is more common to harvest rainwater from rooftops, which is the focus of this fact sheet.

When designing your system, consider the roofing material on the building.

- If you have asphalt or wooden shingles, use the harvested rainwater only for non-edible landscapes, unless the water is treated first. Petroleum or other chemicals from these roofing materials can leach into the rain water.
- Roofs with cement, clay, or metal surfaces are ideal for harvesting water for a wide variety of uses.

### Gutters and Downspouts

Properly sized and maintained gutters and downspouts are essential to a rainwater harvesting system.

- Strategically locate any new downspouts in an area where the rain barrel or cistern will be most useful.
- Consider the height of the rain barrel and the first flush device. Existing downspouts may have to be shortened to make room for the rain barrel and first flush device.
- Install a fine mesh gutter guard on gutters to keep leaves and other debris from entering and clogging the gutters. This will reduce the need for cleaning gutters and the rain barrel or cistern.
- As needed, consult a professional roofer to aid in gutter and downspout installation.



This gutter is covered by a fine mesh gutter guard to keep debris out.  
Courtesy of Gutter Glove

## Components of a Rainwater Harvesting System

### Rain Barrel and Cistern Accessories to Keep Water Clean



First flush and downspout diverter installation  
Courtesy of The City of Oakland

Various accessories to rain barrels and cisterns help protect the quality of harvested water and reduce maintenance. These accessories include "first flush" diverters, filters, and screens.

Leaves, twigs, sediment, and animal waste are common in runoff, especially at the beginning of a storm ("first flush"). This debris can result in clogging and encourage bacterial growth. A first flush diverter helps remove debris and contaminants by directing the first few gallons of runoff from the roof to landscaping, away from the rain barrel or cistern.

The following tips will help you keep the water in your system clean.

- Install a first flush diverter directly under your downspout. You may have to cut the downspout to connect the first flush diverter above the rain barrel.
- Use the same diameter pipe for the first flush diverter, the downspout, and the connector to the rain barrel. Avoid changing diameters of pipes in order to keep the system from backing up.
- Design the first flush diverter to discharge the first flush to non-edible landscaping.
- Install mosquito-proof screens under the lid of the rain barrel and inside the overflow outlet.

### Foundation and Overflow

Before installing a rain barrel or cistern, prepare the site so that the system will function safely.

- Find or create a level location near the downspout on which to place the rain barrel or cistern.
- A concrete or stone paver foundation may be appropriate for smaller rain barrels. A more substantial foundation will likely be required for large cisterns.
- Secure rain barrels and cisterns to your structure with metal strapping, or anchor to the foundation, to prevent tipping in an earthquake.
- Maintain clear access to the rain barrel outlets and cleaning access points.
- Design an overflow path, so that overflow from the rain barrel(s) will discharge safely to a landscaped area, or storm drain system.
- Where possible, direct overflow to a rain garden, swale, or other landscaped area to maximize retention of rainwater onsite.
- Direct the overflow away from the rain barrel, building foundation, and neighboring properties.
- Consult with the municipality to identify overflow locations.



Large unit installed at a single family residence.  
Courtesy of Stephanie Morris